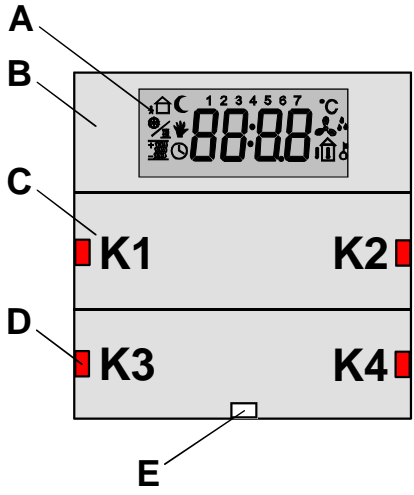
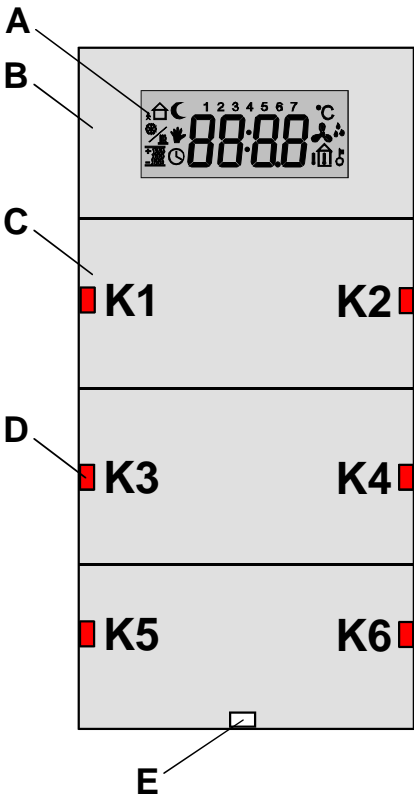

# Push button 2, 3, 5gang with room thermostat (RTR) and display flush-mounted

## 756627xx, 756637xx, 756657xx

<b>Product name:</b>	Push button 2-, 3-, 5- gang RTR + display
<b>Design:</b>	UP (flush-mounting type)
<b>ETS search path:</b>	Push button / Push button xgang / Push button xgang with RTR + display
<b>Status:</b>	05.04.2006
<b>Functions:</b>	<p>Push button functions:</p> <p>Depending on the parameter settings, a key-press on the push button with RTR and display will transmit the appropriate telegrams to the KNX / EIB. This, for example, can be telegrams for switching or pushing, for dimming (also one-touch dimming) or for shutter control with different operation concepts. It is also possible to program value transmitter functions such as 1-byte value transmitter, light-scene extension for the recall of externally or internally stored light-scenes or 2-byte value transmitter (for instance temperature or brightness value transmitter). Another function allows the transmission of different switching or value commands with only one key-press.</p> <p>The operation distinguishes between a key and a rocker operation concept. The different functions can be assigned to the keys or rockers independently of each other. In addition, the push button with RTR and display allows to either selectively disable individual rockers or the entire push button.</p> <p>Room temperature regulator functions:</p> <p>The push button with RTR and display can be used to control the temperature of individual rooms. In doing so the controller can distinguish and control up to two control circuits optionally with their own temperature-setpoints. Thus it is possible, for example, to have several heaters in larger or rambling rooms or the underfloor heating controlled separately by their own control algorithms.</p> <p>Depending on the control option of the current temperature-setpoint and the room temperature, an actuating variable for the heating or cooling control system can be transmitted to the KNX / EIB for both control circuits.</p> <p>In a control circuit the room temperature can be measured by an internal (inside the push button housing) or optionally by an external temperature sensor. If the second control circuit is activated, the room temperature of the first circuit is determined by the internal sensor whereas the room temperature of the second circuit is determined by the external sensor.</p> <p>If only one control circuit is utilized, it is possible to set up an extra heating and / or cooling unit by activating an additional stage in addition to the basic stage for heating and cooling. The temperature-setpoint difference between the basic and the additional stage can be set via parameters. For larger deviations between the setpoint and actual-temperature, the room can therefore be heated-up or cooled down more quickly by switching on the additional stage. Different control algorithms can be assigned to the basic and additional stage.</p> <p>The controller can operate in 5 operating modes (comfort, standby, night, frost/ heat protection and controller disable) each having their own temperature-setpoints for the heating mode or cooling mode. Continuous or switching PI or switching 2-point control algorithms can be selected for the heating and cooling functions. A room temperature time-switch allows for the time-of-day and day-of-week control of the operating modes.</p> <p>Controller extension functions:</p> <p>Alternatively to its function as a room temperature regulator, the push button with RTR and display can act as a controller extension. In this manner it can adequately control and operate via its keys or rockers one or several push buttons RTR which operate as controllers via KNX / EIB communication objects. The display of the controller extension can also be controlled via objects so that, among other things, the current temperature values and the active operating modes will also be displayed on all extensions.</p> <p>Scene function:</p> <p>The push button with RTR and display can be programmed for up to 8 different scenes. Each scene can control up to 8 different scene objects via switching, value or shutter commands. The scene recall or the storing of new scene values takes place via an extension object or via touch control.</p>

**Push button 2, 3, 5gang with room thermostat (RTR) and display flush-mounted**  
**756627xx, 756637xx, 756657xx**

Layout:	Dimensions:	Controls:
<p style="text-align: center;">2gang</p> 	<p>Width: 70 mm            Height: 55 mm            Depth: 13 mm (without PEI)</p>	<p><b>Controls:</b></p> <p>A: Display            B: Display keys (left and right of the display)            C: Rockers 1 – 2 or Keys 1 to 4 (push button function)            D: 2 x 2 status-LED (red) for the status indications of the keys or rockers            E: 1 operation-LED (white)</p>
<p style="text-align: center;">3gang</p> 	<p>Width: 70 mm            Height: 110 mm            Depth: 13 mm (without PEI)</p>	<p><b>Controls:</b></p> <p>A: Display            B: Display keys (left and right of the display)            C: Rockers 1 – 3 or Keys 1 to 6 (push button function)            D: 3 x 2 status-LED (red) for the status indications of the keys or rockers            E: 1 operation-LED (white)</p>

**Push button 2, 3, 5gang with room thermostat (RTR) and display flush-mounted**  
**756627xx, 756637xx, 756657xx**

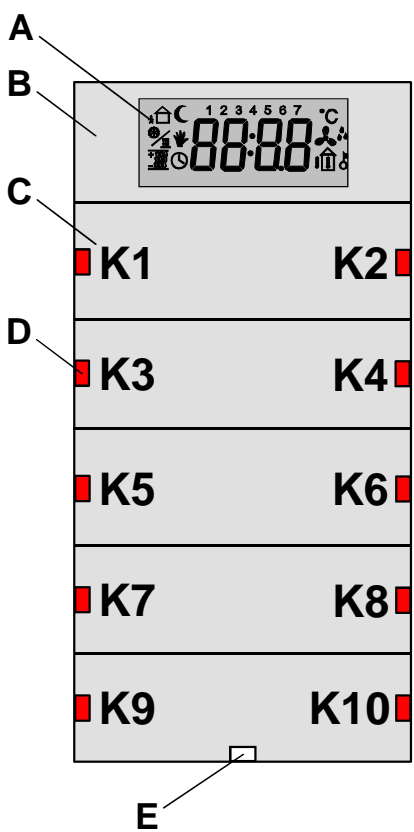
<p style="text-align: center;">5gang</p> 	<p>Width: 70 mm</p> <p>Height: 110 mm</p> <p>Depth: 13 mm (without PEI)</p>	<p>A: Display</p> <p>B: Display keys (left and right of the display)</p> <p>C: Rockers 1 – 5 or Keys 1 to 10 (push button function)</p> <p>D: 5 x 2 status-LED (red) for the status indications of the keys or rockers</p> <p>E: 1 operation-LED (white)</p>
---	---	--

Order no.:

Push button	Berker no.	
Push button 2 gang with RTR + display	7566 27 xx	
Push button 3 gang with RTR + display	7566 37 xx	
Push button 5 gang with RTR + display	7566 57 xx	

**Push button 2, 3, 5gang with room thermostat (RTR) and display flush-mounted**  
**756627xx, 756637xx, 756657xx**

Technical data	
Type of protection:	IP 20
Safety class:	III
Mark of approval:	KNX / EIB
Ambient temperature:	-5 °C ... +45 °C
Storage/ transport temperature:	-25 °C ... +70 °C (storage over +45 °C will reduce product life)
Mounting position:	Any (preferably vertical/ display up)
Minimum distances:	None
Type of fastening:	Plugging onto flush-mounted BCU
<b>Supply instabus EIB</b>	
Voltage:	21 – 32 V DC (via flush-mounted BCU)
Power consumption:	Typically 150 mW (via flush-mounted BCU)
Wiring:	2 x 5 pole male connector strip (PEI)
<b>External supply</b>	
---	
<b>Room temperature regulator (internal temperature sensor):</b>	
Measuring range:	0 °C ... + 40 °C ±1 %
Resolution:	0.1 K
Atmospheric humidity:	0 % to 95 % (no moisture condensation)
<b>Internal clock:</b>	
Resolution:	1 minute
Deviation:	Max. of 8 minutes a day In order to minimize the deviation, the internal clock should be set and thus be updated hourly via the bus.
<b>Response to voltage failure</b>	
Bus voltage only:	All object values will be deleted. Push button function: no response, LED's switch off Room temperature regulator: no response, control off
Mains voltage only:	---
Bus and mains voltage:	---
<b>Response to return of voltage</b>	
Bus voltage only:	Push button function: no response Room temperature regulator: The controller initializes. According to the parameterization, different temperature values and the status will be transmitted and the switch-over objects will be updated.
Mains voltage only:	---
Bus and mains voltage:	---
Input:	---
Output:	---

**Push button 2, 3, 5gang with room thermostat (RTR) and display flush-mounted**  
**756627xx, 756637xx, 756657xx**

**Wiring:**

**Terminal connections:**

The push button with RTR and display is plugged onto a flush-mounted bus coupler (UO BCU 1).

e.g. 5 gang

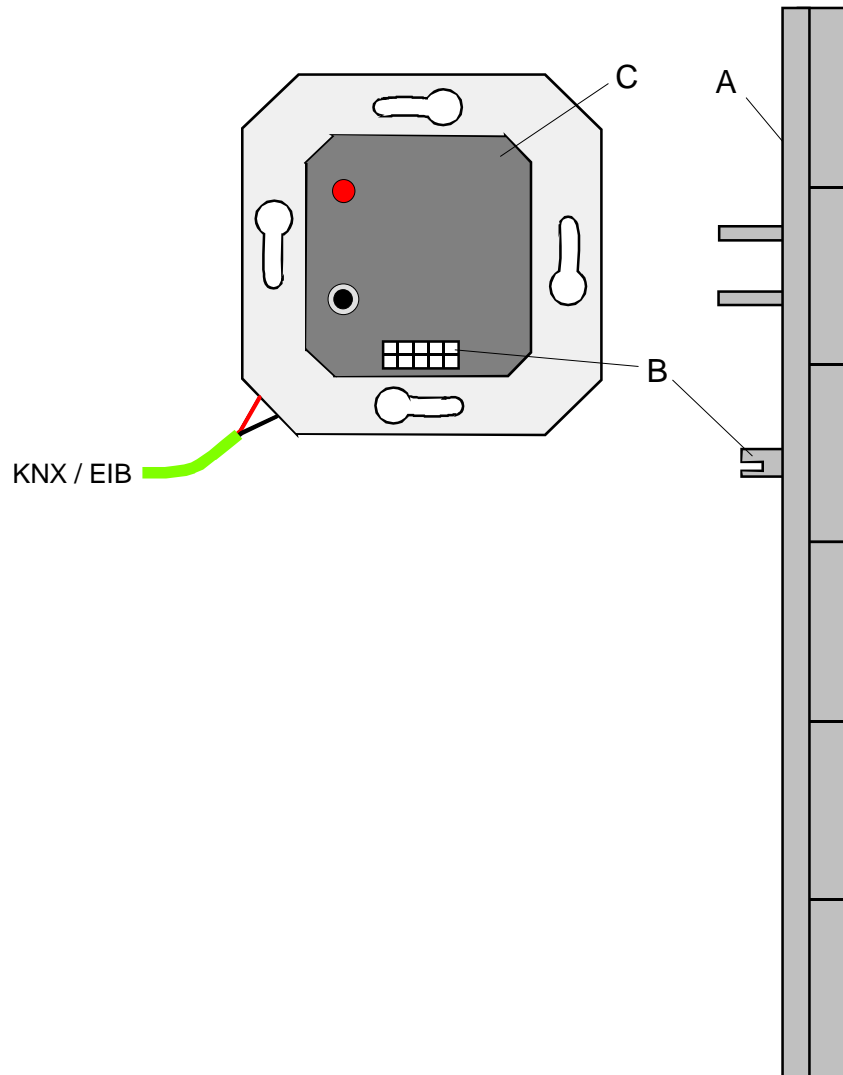

- A: Push button with RTR and display 2 gang / 3 gang / 5 gang
- B: Physical external interface (PEI)
- C: Bus coupling unit

**Hardware information**

- The push button with RTR and display may only be plugged onto more recent bus coupler models featuring a flat installation housing! The push button with RTR and display does not function properly when mounted on older flush-mounted bus coupler models featuring a deep housing (other distinctive feature: rectangular programming key).

**Push button 2, 3, 5gang with room thermostat (RTR) and display flush-mounted**  
**756627xx, 756637xx, 756657xx**

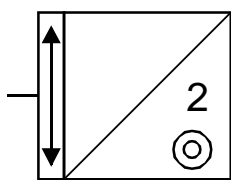
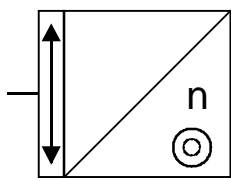
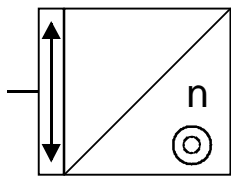
Software information			
ETS search path:		ETS search path:	
Push button /Push button 2 gang / Push button 2 gang with RTR + display			
PEI type	00 <sub>Hex</sub>	0 <sub>Dec</sub>	No adapter used
Application:			
No.	Summarized description:	Name:	Version:
1	Push button with room temperature regulator	Multifunction RTR + display 16A201	0.1
ETS search path:		ETS search path:	
Push button /Push button 3 gang / Push button 3 gang with RTR + display			
PEI type	00 <sub>Hex</sub>	0 <sub>Dec</sub>	No adapter used
Application:			
No.	Summarized description:	Name:	Version:
1	Push button with room temperature regulator	Multifunction RTR + display 16A201	0.1
ETS search path:		ETS search path:	
Push button /Push button 5 gang / Push button 5 gang with RTR + display			
PEI type	00 <sub>Hex</sub>	0 <sub>Dec</sub>	No adapter used
Application:			
No.	Summarized description:	Name:	Version:
1	Push button with room temperature regulator	Multifunction RTR + display 16A201	0.1

**Push button 2, 3, 5gang with room thermostat (RTR) and display flush-mounted**  
**756627xx, 756637xx, 756657xx**













<b>Application:</b>		1. Multifunction RTR + display 16A201 Multifunction RTR + display 16A301 Multifunction RTR + display 16A501			
<b>Executable from mask version:</b>		1.2			
<b>Number of addresses (max):</b>	75	<b>dynamic table management</b>	Yes <input type="checkbox"/>	No <input checked="" type="checkbox"/>	
<b>Number of assignments (max):</b>	200	<b>maximum table length</b>	75 BCU + 200 µC applications		
<b>Communication objects:</b>		77			
<b>Push button functions:</b>					
The following objects apply solely for the „Concept of operation = 2 push buttons (2 objects)“:					
<b>Function:</b> no function (for all 4 keys (2 rockers), 6 keys (3 rockers) or 10 keys (5 rockers) <sup>1)</sup> )					
<b>Object</b>	<b>Function</b>	<b>Name</b>	<b>DPT-ID</b>	<b>Type</b>	<b>Flag</b>
<input type="checkbox"/> ← 67-76	Status	Key 1 – Key 10 <sup>1)</sup>	1.001	1-bit	C, W
<b>Function:</b> Switching / pushing (for all 4 keys (2 rockers), 6 keys (3 rockers) or 10 keys (5 rockers) <sup>1)</sup> )					
<b>Object</b>	<b>Function</b>	<b>Name</b>	<b>DPT-ID</b>	<b>Type</b>	<b>Flag</b>
<input type="checkbox"/> ← 0-9	Switching	Key 1 – Key 10 <sup>1)</sup>	1.001	1-bit	C, W, T
<input type="checkbox"/> ← 67-76	Status	Key 1 – Key 10 <sup>1)</sup>	1.001	1-bit	C, W
<b>Function:</b> Dimming (for all 4 keys (2 rockers), 6 keys (3 rockers) or 10 keys (5 rockers) <sup>1)</sup> )					
<b>Object</b>	<b>Function</b>	<b>Name</b>	<b>DPT-ID</b>	<b>Type</b>	<b>Flag</b>
<input type="checkbox"/> ← 0-9	Switching	Key 1 – Key 10 <sup>1)</sup>	1.001	1-bit	C, W, T
<input type="checkbox"/>   10-19	Dimming	Key 1 – Key 10 <sup>1)</sup>	3.007	4-bit	C, T
<input type="checkbox"/> ← 67-76	Status	Key 1 – Key 10 <sup>1)</sup>	1.001	1-bit	C, W
<b>Function:</b> Shutter (for all 4 keys (2 rockers), 6 keys (3 rockers) or 10 keys (5 rockers) <sup>1)</sup> )					
<b>Object</b>	<b>Function</b>	<b>Name</b>	<b>DPT-ID</b>	<b>Type</b>	<b>Flag</b>
<input type="checkbox"/>   0-9	STEP operation	Key 1 – Key 10 <sup>1)</sup>	1.007	1-bit	C, T
<input type="checkbox"/>   10-19	MOVE operation	Key 1 – Key 10 <sup>1)</sup>	1.008	1-bit	C, T
<input type="checkbox"/> ← 67-76	Status	Key 1 – Key 10 <sup>1)</sup>	1.001	1-bit	C, W
<b>Function:</b> Value transmitter 1-byte (for all 4 keys (2 rockers), 6 keys or (3 rockers) or 10 keys (5 rockers) <sup>1)</sup> )					
<b>Object</b>	<b>Function</b>	<b>Name</b>	<b>DPT-ID</b>	<b>Type</b>	<b>Flag</b>
<input type="checkbox"/>   0-9	Value transmitter	Key 1 – Key 10 <sup>1)</sup>	4.001, 4.002, 5.001, 5.003, 5.004, 5.010, 6.010	1-byte	C, T
<input type="checkbox"/> ← 67-76	Status	Key 1 – Key 10 <sup>1)</sup>	1.001	1-bit	C, W
<b>Function:</b> Value transmitter 2 byte (for all 4 keys (2 rockers), 6 keys or (3 rockers) or 10 keys (5 rockers) <sup>1)</sup> )					
<b>Object</b>	<b>Function</b>	<b>Name</b>	<b>DPT-ID</b>	<b>Type</b>	<b>Flag</b>
<input type="checkbox"/>   0-9	Value transmitter [temp. / brightness]	Key 1 – Key 10 <sup>1)</sup>	7.001, 7.010, 8.001, 9.0xx	2 byte	C, T
<input type="checkbox"/> ← 67-76	Status	Key 1 – Key 10 <sup>1)</sup>	1.001	1-bit	C, W
<sup>1):</sup> The „no function“, „switching/pushing“, „dimming“, „shutter“, „value transmitter 1-byte“, „value transmitter 2byte“, „light scene extension / light scene recall“, „two telegrams“, „operating mode switch-over“ and „room temperature timer operation“ functions can be selected per key. Accordingly, the names of the communication objects and the object table (dynamic object structure) change. It is also possible to combine key or rocker functions.					

**Push button 2, 3, 5gang with room thermostat (RTR) and display flush-mounted**  
**756627xx, 756637xx, 756657xx**

<b>Function:</b> Light-scene extension / light scene recall (for all 4 keys (2 rockers), 6 keys (3 rockers) or 10 keys (5 rockers) <sup>1</sup> )					
Object	Function	Name	DPT-ID	Type	Flag
□   0-9	Scene extension <sup>2</sup>	Key 1 – Key 10 <sup>1</sup>	18.001	1-byte	C, T
□←   67-76	Status	Key 1 – Key 10 <sup>1</sup>	1.001	1-bit	C, W
<b>Function:</b> Two telegrams (for all 4 keys (2 rockers), 6 keys (3 rockers) or 10 keys (5 rockers) <sup>1</sup> ) Type = switching for both objects.					
Object	Function	Name	DPT-ID	Type	Flag
□   0-9	Switching 2-stage A	Key 1 – Key 10 <sup>1</sup>	1.001	1-bit	C, W, T
□   10-19	Switching 2-stage B	Key 1 – Key 10 <sup>1</sup>	1.001	1-bit	C, W, T
□←   67-76	Status	Key 1 – Key 10 <sup>1</sup>	1.001	1-bit	C, W
Type = Value for both objects.					
Object	Function	Name	DPT-ID	Type	Flag
□   0-9	Value 2-stage A	Key 1 – Key 10 <sup>1</sup>	4.001, 4.002, 5.001, 5.003, 5.004, 5.010, 6.010	1-byte	C, T
□   10-19	Value 2-stage B	Key 1 – Key 10 <sup>1</sup>	4.001, 4.002, 5.001, 5.003, 5.004, 5.010, 6.010	1-byte	C, T
□←   67-76	Status	Key 1 – Key 10 <sup>1</sup>	1.001	1-bit	C, W
<b>Function</b> Operating mode switch-over / setpoint shifting / room temperature timer operation (for all 4 keys (2 gang), 6 keys (3 gang) or 10 keys (5 gang) <sup>1</sup> )					
Object	Function	Name	DPT-ID	Type	Flag
□←   67-76	Status	Key 1 – Key 10 <sup>1</sup>	1.001	1-bit	C, W
<p><sup>1</sup>: The „no function“, „switching/pushing“, „dimming“, „shutter“, „value transmitter 1-byte“, „value transmitter 2 byte“, „light scene extension / -recall“, „two telegrams“, „operating mode switch-over“, „setpoint shifting“ and „room temperature timer operation“ functions can be selected per key. Accordingly, the names of the communication objects and the object table (dynamic object structure) change. It is also possible to combine key or rocker functions.</p> <p><sup>2</sup>: The scene extension object is not visible when set to „function as = recall internal scene request“.</p>					



**Push button 2, 3, 5gang with room thermostat (RTR) and display flush-mounted**  
**756627xx, 756637xx, 756657xx**

<b>The following objects apply solely for the „Concept of operation = rocker (1 object)“:</b>						
<b>Function:</b> no function (2 rockers (2 rockers), 3 rockers (3 rockers), 5 rockers (5 rockers) <sup>3)</sup>						
Object	Function	Name	DPT-ID	Type	Flag	
 67...75	Status left	Rocker 1 – Rocker 5	1.001	1-bit	C, W	
 68...76	Status right	Rocker 1 – Rocker 5	1.001	1-bit	C, W	
<b>Function:</b> Switching (2 rockers (2 rockers), 3 rockers (3 rockers), 5 rockers (5 rockers) <sup>3)</sup>						
Object	Function	Name	DPT-ID	Type	Flag	
 0/2/4/6/8	Switching	Rocker 1 – Rocker 5	1.001	1-bit	C, W, T	
 67...75	Status left	Rocker 1 – Rocker 5	1.001	1-bit	C, W	
 68...76	Status right	Rocker 1 – Rocker 5	1.001	1-bit	C, W	
<b>Function:</b> Dimming (2 rockers (2 rockers), 3 rockers (3 rockers), 5 rockers (5 rockers) <sup>3)</sup>						
Object	Function	Name	DPT-ID	Type	Flag	
 0/2/4/6/8	Switching	Rocker 1 – Rocker 5	1.001	1-bit	C, W, T	
 10/12/14/16/18	Dimming	Rocker 1 – Rocker 5	3.007	4-bit	C, T	
 67...75	Status left	Rocker 1 – Rocker 5	1.001	1-bit	C, W	
 68...76	Status right	Rocker 1 – Rocker 5	1.001	1-bit	C, W	
<b>Function:</b> Shutter (2 rockers (2 rockers), 3 rockers (3 rockers), 5 rockers (5 rockers) <sup>3)</sup>						
Object	Function	Name	DPT-ID	Type	Flag	
 0/2/4/6/8	STEP operation	Rocker 1 – Rocker 5	1.007	1-bit	C, T	
 10/12/14/16/18	MOVE operation	Rocker 1 – Rocker 5	1.008	1-bit	C, T	
 67...75	Status left	Rocker 1 – Rocker 5	1.001	1-bit	C, W	
 68...76	Status right	Rocker 1 – Rocker 5	1.001	1-bit	C, W	
<sup>3)</sup> The „no function“, „switching“, „dimming“, „shutter“, „two telegrams“ and „operating mode switch-over“ functions can be selected per rocker. Accordingly, the names of the communication objects and the object table (dynamic object structure) change. It is also possible to combine key or rocker functions.						

**Push button 2, 3, 5gang with room thermostat (RTR) and display flush-mounted**  
**756627xx, 756637xx, 756657xx**

<b>Function:</b> Two telegrams (2 rockers (2 rockers), 3 rockers (3 rockers), 5 rockers (5 rockers) <sup>3)</sup> Type = switching for both objects.						
Object	Function	Name	DPT-ID	Type	Flag	
□   0-9	Switching 2-stage A	Rocker 1 – Rocker 5	1.001	1-bit	C, W, T	
□   10-19	Switching 2-stage B	Rocker 1 – Rocker 5	1.001	1-bit	C, W, T	
□← 67...75	Status left	Rocker 1 – Rocker 5	1.001	1-bit	C, W	
□← 68...76	Status right	Rocker 1 – Rocker 5	1.001	1-bit	C, W	
Type = Value for both objects.						
Object	Function	Name	DPT-ID	Type	Flag	
□   0-9	Value 2-stage A	Rocker 1 – Rocker 5	4.001, 4.002, 5.001, 5.003, 5.004, 5.010, 6.010	1-byte	C, T	
□   10-19	Value 2-stage B	Rocker 1 – Rocker 5	4.001, 4.002, 5.001, 5.003, 5.004, 5.010, 6.010	1-byte	C, T	
□← 67...75	Status left	Rocker 1 – Rocker 5	1.001	1-bit	C, W	
□← 68...76	Status right	Rocker 1 – Rocker 5	1.001	1-bit	C, W	
<b>Function:</b> Operating mode switch-over (2 rockers (2 rockers), 3 rockers (3 rockers), 5 rockers (5 rockers) <sup>3)</sup>						
Object	Function	Name	DPT-ID	Type	Flag	
□← 67...75	Status left	Rocker 1 – Rocker 5	1.001	1-bit	C, W	
□← 68...76	Status right	Rocker 1 – Rocker 5	1.001	1-bit	C, W	
<sup>3)</sup> : The „no function“, „switching“, „dimming“, „shutter“, „two telegrams“ and „operating mode switch-over“ functions can be selected per rocker. Accordingly, the names of the communication objects and the object table (dynamic object structure) change. It is also possible to combine key or rocker functions.						
<b>With „concept of operation= without function“ for all 3 rockers / 6 keys (3-gang sensor), for all 4 rockers / 8 keys (4-gang sensor) or for all 5 rockers / 10 keys (5-gang sensor) there are no objects for keys or rockers available!</b>						

**Push button 2, 3, 5gang with room thermostat (RTR) and display flush-mounted**  
**756627xx, 756637xx, 756657xx**

The following objects are available for the disable function (push button function), the operation-LED or for the alarm function:

**Function:** Alarm message (data format: switching telegram 1-bit)

Object	Function	Name	DPT-ID	Type	Flag
   20	Switching	Alarm message	1.001	1-bit	C, T <sup>4</sup>

**Function:** Alarm message (data format: value telegram: 1-byte)

Object	Function	Name	DPT-ID	Type	Flag
   20	Value transmitter	Alarm message	4.001, 4.002, 5.001, 5.003, 5.004, 5.010, 6.010	1-byte	C, T

**Function:** Disable function

Object	Function	Name	DPT-ID	Type	Flag
   21	Disable function	Disable push-button	1.001	1-bit	C, W















**Function:** Switching the operation-LED

Object	Function	Name	DPT-ID	Type	Flag
   22	Switching	Operation-LED	1.001	1-bit	C, W

<sup>4</sup>: The „alarm message“ object can only be assigned one group address!

R-flag: The objects can only be read out, if the push button is plugged on!







**Push button 2, 3, 5gang with room thermostat (RTR) and display flush-mounted**  
**756627xx, 756637xx, 756657xx**

Room temperature regulator functions:					
<b>Function:</b> Actual-temperature					
Object	Function	Name	DPT-ID	Type	Flag
 23	Actual-temperature	Measures adapted value	9.001	2 byte	C, R, T
<b>Function:</b> additional temperature sensor					
Object	Function	Name	DPT-ID	Type	Flag
 24	External temperature sensor	Temperature value	9.001	2 byte	C, W, T
 25	Outside temperature sensor	Temperature value	9.001	2 byte	C, W
<b>Function:</b> Presetting basic setpoint					
Object	Function	Name	DPT-ID	Type	Flag
 26	Basic setpoint	Preset temperature	9.001	2 byte	C, W
 27	Basic setpoint 2 <sup>nd</sup> control circuit <sup>5</sup>	Preset temperature	9.001	2 byte	C, W
<b>Function:</b> Operating mode switch-over Operating mode switch „via value (1-byte)“:					
Object	Function	Name	DPT-ID	Type	Flag
 28	Operating mode switch-over	KONNEX operating mode switch-over	---	1-byte	C, W(, T) <sup>6</sup>
 32	Operating mode forced-control	KONNEX operating mode switch-over	---	1-byte	C, W
Operating mode switch-over „by switching (4 x 1-bit)“					
Object	Function	Name	DPT-ID	Type	Flag
 28	Comfort mode	Operating mode switch-over	1.001	1-bit	C, W(, T) <sup>6</sup>
 29	Standby mode	Operating mode switch-over	1.001	1-bit	C, W(, T) <sup>6</sup>
 30	Night mode	Operating mode switch-over	1.001	1-bit	C, W(, T) <sup>6</sup>
 31	Frost/ heat protection	Operating mode switch-over	1.001	1-bit	C, W(, T) <sup>6</sup>
Presence object and window status:					
Object	Function	Name	DPT-ID	Type	Flag
 33	Presence object	Presence key / presence detector	1.001	1-bit	C, W, T
 34	Windows status	Window contact	1.001, 1.019	1-bit	C, W
<b>Function:</b> Control option switching					
Object	Function	Name	DPT-ID	Type	Flag
 35	Heating / cooling <sup>7</sup>	Control option switching	1.001	1-bit	C, W(, T)
<p><sup>5</sup>: This object is only active if the 2<sup>nd</sup> control circuit has been activated and if both circuits have their own setpoints.</p> <p><sup>6</sup>: Optionally, the „T“ flags can be set for the operating mode switch-over. Once the flags are set the object values, which have changed according to the newly set operating mode, will be actively transmitted on the bus.</p> <p><sup>7</sup>: This object is only active with one control circuit in the „heating and cooling“ or „basic /additional - heating/ cooling“ mixed-mode operation. The „T“ flag is set for automatic heating / cooling switch-over.</p>					

**Push button 2, 3, 5gang with room thermostat (RTR) and display flush-mounted**  
**756627xx, 756637xx, 756657xx**

Room temperature regulator functions:						
<b>Function:</b> Status indication						
Object	Function	Name	DPT-ID	Type	Flag	
<input type="checkbox"/>	36	Controller status	Status indication general	---	1-byte	C, T
<input type="checkbox"/>	36	Controller status	Status indication individually	1.001	1-bit	C, T
<input type="checkbox"/>	37	Indication heating	Indication	1.001	1-bit	C, T
<input type="checkbox"/>	38	Indication cooling	Indication	1.001	1-bit	C, T
<b>Function:</b> Disable function (room temperature regulator)						
Object	Function	Name	DPT-ID	Type	Flag	
<input type="checkbox"/>	39	Controller operation disable	Disable function	1.001	1-bit	C, W
<input type="checkbox"/>	40	Controller disable	Disable function	1.001	1-bit	C, W
<input type="checkbox"/>	41	Disable additional stage <sup>8</sup>	Disable function	1.001	1-bit	C, W
<input type="checkbox"/>	41	2 <sup>nd</sup> disable control circuit <sup>8</sup>	Disable function	1.001	1-bit	C, W
<b>Function:</b> Actuating variable heating						
No additional stage activated / one control circuit /						
For mixed-mode: Actuating variable output „heating“ and „cooling“ via <u>separate</u> objects:						
Object	Function	Name	DPT-ID	Type	Flag	
<input type="checkbox"/>	42	Heating (control circuit 1)	Continuous actuating variable	5.001	1-byte	C, W, T
<input type="checkbox"/>	42	Heating (control circuit 1)	PWM actuating variable	1.001	1-bit	C, W, T
<input type="checkbox"/>	42	Heating (control circuit 1)	Switching actuating variable	1.001	1-bit	C, W, T
No additional stage is activated / one control circuit /						
For mixed-mode: Actuating variable output „heating“ and „cooling“ via a <u>shared</u> object:						
Object	Function	Name	DPT-ID	Type	Flag	
<input type="checkbox"/>	42	Heating/cooling (control circuit 1)	Continuous actuating variable	5.001	1-byte	C, W, T
<input type="checkbox"/>	42	Heating/cooling (control circuit 1)	PWM actuating variable	1.001	1-bit	C, W, T
<input type="checkbox"/>	42	Heating/cooling (control circuit 1)	Switching actuating variable	1.001	1-bit	C, W, T
Additional stage is activated / one control circuit /						
For mixed-mode: Actuating variable output „heating“ and „cooling“ via <u>separate</u> objects:						
Object	Function	Name	DPT-ID	Type	Flag	
<input type="checkbox"/>	42	basic heating (control circuit 1)	Continuous actuating variable	5.001	1-byte	C, W, T
<input type="checkbox"/>	42	basic heating (control circuit 1)	PWM actuating variable	1.001	1-bit	C, W, T
<input type="checkbox"/>	42	basic heating (control circuit 1)	Switching actuating variable	1.001	1-bit	C, W, T
<input type="checkbox"/>	43	additional heating (control circuit 1)	Continuous actuating variable	5.001	1-byte	C, W, T
<input type="checkbox"/>	43	additional heating (control circuit 1)	PWM actuating variable	1.001	1-bit	C, W, T
<input type="checkbox"/>	43	additional heating (control circuit 1)	Switching actuating variable	1.001	1-bit	C, W, T

**Push button 2, 3, 5gang with room thermostat (RTR) and display flush-mounted**  
**756627xx, 756637xx, 756657xx**













Two control circuits:						
Object	Function	Name	DPT-ID	Type	Flag	
 42	Heating (control circuit 1)	Continuous actuating variable	5.001	1-byte	C, W, T	
 42	Heating (control circuit 1)	PWM actuating variable	1.001	1-bit	C, W, T	
 42	Heating (control circuit 1)	Switching actuating variable	1.001	1-bit	C, W, T	
 46	Heating (control circuit 2)	Continuous actuating variable	5.001	1-byte	C, W, T	
 46	Heating (control circuit 2)	PWM actuating variable	1.001	1-bit	C, W, T	
 46	Heating (control circuit 2)	Switching actuating variable	1.001	1-bit	C, W, T	

<sup>8</sup>: This object is only visible with activated additional stage or alternatively with two control circuits.

**Push button 2, 3, 5gang with room thermostat (RTR) and display flush-mounted**  
**756627xx, 756637xx, 756657xx**

Additional stage is activated / one control circuit /					
For mixed-mode operation: Actuating variable output „heating“ and „cooling“ via a shared object:					
Object	Function	Name	DPT-ID	Type	Flag
42	Basic heating and basic cooling (control circuit 1)	Continuous actuating variable	5.001	1-byte	C, W, T
42	Basic heating and basic cooling (control circuit 1)	PWM actuating variable	1.001	1-bit	C, W, T
42	Basic heating and basic cooling (control circuit 1)	Switching actuating variable	1.001	1-bit	C, W, T
43	Additional heating and cooling (control circuit 1)	Continuous actuating variable	5.001	1-byte	C, W, T
43	Additional heating and cooling (control circuit 1)	PWM actuating variable	1.001	1-bit	C, W, T
43	Additional heating and cooling (control circuit 1)	Switching actuating variable	1.001	1-bit	C, W, T
<b>Function:</b> Actuating variable cooling					
No additional stage is activated / one control circuit /					
For mixed-mode: Actuating variable output „heating“ and „cooling“ via separate objects:					
Object	Function	Name	DPT-ID	Type	Flag
44	Cooling (control circuit 1)	Continuous actuating variable	5.001	1-byte	C, W, T
44	Cooling (control circuit 1)	PWM actuating variable	1.001	1-bit	C, W, T
44	Cooling (control circuit 1)	Switching actuating variable	1.001	1-bit	C, W, T
Additional stage is activated / one control circuit /					
For mixed-mode: Actuating variable output „heating“ and „cooling“ via separate objects:					
Object	Function	Name	DPT-ID	Type	Flag
44	basic cooling (control circuit 1)	Continuous actuating variable	5.001	1-byte	C, W, T
44	basic cooling (control circuit 1)	PWM actuating variable	1.001	1-bit	C, W, T
44	basic cooling (control circuit 1)	Switching actuating variable	1.001	1-bit	C, W, T
45	additional cooling (control circuit 1)	Continuous actuating variable	5.001	1-byte	C, W, T
45	additional cooling (control circuit 1)	PWM actuating variable	1.001	1-bit	C, W, T
45	additional cooling (control circuit 1)	Switching actuating variable	1.001	1-bit	C, W, T
Two control circuits:					
Object	Function	Name	DPT-ID	Type	Flag
44	Cooling (control circuit 1)	Continuous actuating variable	5.001	1-byte	C, W, T
44	Cooling (control circuit 1)	PWM actuating variable	1.001	1-bit	C, W, T
44	Cooling (control circuit 1)	Switching actuating variable	1.001	1-bit	C, W, T
48	Cooling (control circuit 2)	Continuous actuating variable	5.001	1-byte	C, W, T
48	Cooling (control circuit 2)	PWM actuating variable	1.001	1-bit	C, W, T
48	Cooling (control circuit 2)	Switching actuating variable	1.001	1-bit	C, W, T

**Push button 2, 3, 5gang with room thermostat (RTR) and display flush-mounted**  
**756627xx, 756637xx, 756657xx**

<b>Function:</b> Actuating variable status information heating <sup>9</sup>						
<b>Object</b>	<b>Function</b>	<b>Name</b>	<b>DPT-ID</b>	<b>Type</b>	<b>Flag</b>	
 46	Heating (control circuit 1)	PWM actuating variable	5.001	1-byte	C, W, T	
 46	Basic heating (control circuit 1)	PWM actuating variable	5.001	1-byte	C, W, T	
 47	Additional heating (control circuit 1)	PWM actuating variable	5.001	1-byte	C, W, T	
<b>Function:</b> Actuating variable status information cooling <sup>9</sup>						
<b>Object</b>	<b>Function</b>	<b>Name</b>	<b>DPT-ID</b>	<b>Type</b>	<b>Flag</b>	
 48	Cooling (control circuit 1)	PWM actuating variable	5.001	1-byte	C, W, T	
 48	Basic cooling (control circuit 1)	PWM actuating variable	5.001	1-byte	C, W, T	
 49	Additional cooling (control circuit 1)	PWM actuating variable	5.001	1-byte	C, W, T	
<b>Function:</b> Set temperature						
<b>Object</b>	<b>Function</b>	<b>Name</b>	<b>DPT-ID</b>	<b>Type</b>	<b>Flag</b>	
 50	Set temperature	Temperature value	9.001	2 byte	C, T, R	
 51	Set temperature 2 <sup>nd</sup> control circuit <sup>10</sup>	Temperature value	9.001	2 byte	C, T, R	
<b>Function:</b> Controller extension:						
<b>Object</b>	<b>Function</b>	<b>Name</b>	<b>DPT-ID</b>	<b>Type</b>	<b>Flag</b>	
 52	Current setpoint shifting	Feedback value	6.010	1-byte	C, T, R	
 53	Preset setpoint shifting	Value	6.010	1-byte	C, W	
<b>Function:</b> Time signal						
<b>Object</b>	<b>Function</b>	<b>Name</b>	<b>DPT-ID</b>	<b>Type</b>	<b>Flag</b>	
 54	Time	Time signal	10.001	3 byte	C, W	
<b>Function:</b> Room temperature timer						
<b>Object</b>	<b>Function</b>	<b>Name</b>	<b>DPT-ID</b>	<b>Type</b>	<b>Flag</b>	
 55	Disable function	Disable room temperature timer	1.001	1-bit	C, W	
<sup>9</sup> : The status information for the PWM actuating variable is only possible with one control circuit! <sup>10</sup> : This object is only active if the 2 <sup>nd</sup> control circuit has been activated and both circuits have their own setpoints.						



**Push button 2, 3, 5gang with room thermostat (RTR) and display flush-mounted**  
**756627xx, 756637xx, 756657xx**

<b>Controller extension functions:</b>					
<b>Function:</b> Actual-temperature					
Object	Function	Name	DPT-ID	Type	Flag
☐   23	Actual-temperature	Measures adapted value	9.001	2 byte	C, R, T
<b>Function:</b> additional temperature sensor					
Object	Function	Name	DPT-ID	Type	Flag
☐   24	External temperature sensor	Temperature value	9.001	2 byte	C, W, T
☐   25	External sensor	Temperature value	9.001	2 byte	C, W
<b>Function:</b> Operating mode switch-over With operating mode switch „via value (1-byte)“:					
Object	Function	Name	DPT-ID	Type	Flag
☐   28	Operating mode switch-over Controller extension:	KONNEX operating mode switch-over	---	1-byte	C, R, W, T
☐   32	Operating mode forced-control Controller extension:	KONNEX operating mode switch-over	---	1-byte	C, R, W, T
Presence object:					
Object	Function	Name	DPT-ID	Type	Flag
☐   33	Presence object controller extension	Presence pushbutton	1.001	1-bit	C, W, T
<b>Function:</b> Status indication					
Object	Function	Name	DPT-ID	Type	Flag
☐   36	Controller status Controller extension	Status indication general	---	1-byte	C, W
☐   37	Indication heating controller extension	Indication	1.001	1-bit	C, W
☐   38	Indication cooling controller extension	Indication	1.001	1-bit	C, W
<b>Function:</b> Set temperature					
Object	Function	Name	DPT-ID	Type	Flag
☐   50	Set temperature controller extension	Temperature value	9.001	2 byte	C, W
<b>Function:</b> Controller extension:					
Object	Function	Name	DPT-ID	Type	Flag
☐   52	Current setpoint shifting controller extension	Feedback value	6.010	1-byte	C, W
☐   53	Presetting setpoint shifting controller extension	Value	6.010	1-byte	C, T

**Push button 2, 3, 5gang with room thermostat (RTR) and display flush-mounted**  
**756627xx, 756637xx, 756657xx**

<b>Scene function</b>						
<b>Function:</b> Switching (for all 8 scene objects <sup>12)</sup> )						
Object	Function	Name	DPT-ID	Type	Flag	
<input type="checkbox"/> ← 56	Scene output 1	Switching	1.001	1-bit	C, W, T	
<input type="checkbox"/> ← 57	Scene output 2	Switching	1.001	1-bit	C, W, T	
<input type="checkbox"/> ← 58	Scene output 3	Switching	1.001	1-bit	C, W, T	
<input type="checkbox"/> ← 59	Scene output 4	Switching	1.001	1-bit	C, W, T	
<input type="checkbox"/> ← 60	Scene output 5	Switching	1.001	1-bit	C, W, T	
<input type="checkbox"/> ← 61	Scene output 6	Switching	1.001	1-bit	C, W, T	
<input type="checkbox"/> ← 62	Scene output 7	Switching	1.001	1-bit	C, W, T	
<input type="checkbox"/> ← 63	Scene output 8	Switching	1.001	1-bit	C, W, T	
<b>Function:</b> Value (for all 8 scene objects <sup>12)</sup> )						
Object	Function	Name	DPT-ID	Type	Flag	
<input type="checkbox"/> ← 56	Scene output 1	Value	4.001, 4.002, 5.001, 5.003, 5.004, 5.010, 6.010	1-byte	C, W, T	
<input type="checkbox"/> ← 57	Scene output 2	Value		1-byte	C, W, T	
<input type="checkbox"/> ← 58	Scene output 3	Value		1-byte	C, W, T	
<input type="checkbox"/> ← 59	Scene output 4	Value		1-byte	C, W, T	
<input type="checkbox"/> ← 60	Scene output 5	Value		1-byte	C, W, T	
<input type="checkbox"/> ← 61	Scene output 6	Value		1-byte	C, W, T	
<input type="checkbox"/> ← 62	Scene output 7	Value		1-byte	C, W, T	
<input type="checkbox"/> ← 63	Scene output 8	Value		1-byte	C, W, T	
<b>Function:</b> Shutter position (for all 8 scene objects <sup>12)</sup> )						
Object	Function	Name	DPT-ID	Type	Flag	
<input type="checkbox"/> ← 56	Scene output 1	Shutter position	1.008	1-bit	C, W, T	
<input type="checkbox"/> ← 57	Scene output 2	Shutter position	1.008	1-bit	C, W, T	
<input type="checkbox"/> ← 58	Scene output 3	Shutter position	1.008	1-bit	C, W, T	
<input type="checkbox"/> ← 59	Scene output 4	Shutter position	1.008	1-bit	C, W, T	
<input type="checkbox"/> ← 60	Scene output 5	Shutter position	1.008	1-bit	C, W, T	
<input type="checkbox"/> ← 61	Scene output 6	Shutter position	1.008	1-bit	C, W, T	
<input type="checkbox"/> ← 62	Scene output 7	Shutter position	1.008	1-bit	C, W, T	
<input type="checkbox"/> ← 63	Scene output 8	Shutter position	1.008	1-bit	C, W, T	
<b>Function:</b> Scene extension:						
Object	Function	Name	DPT-ID	Type	Flag	
<input type="checkbox"/> ← 64	Scene extension	Extension input	18.001	1-byte	C, W	
<b>Temperature control</b>						
<b>Function:</b> Temperature alarm:						
Object	Function	Name	DPT-ID	Type	Flag	
<input type="checkbox"/>   65	Switching	Temperature alarm 1	1.001	1-bit	C, T	
<input type="checkbox"/>   66	Switching	Temperature alarm 2	1.001	1-bit	C, T	
<sup>12):</sup> The „switching“, „value“ and „shutter position“ functions can be set per scene object.						

**Push button 2, 3, 5gang with room thermostat (RTR) and display flush-mounted**  
**756627xx, 756637xx, 756657xx**

**Object description**

**Objects:**

□   0 - 9	Switching:	1-bit object for transmission of switching telegrams (ON, OFF).
□   10 - 19	Dimming:	4-bit object for change of relative brightness between 0 and 100 %.
□   0 - 9	STEP operation	1-bit object for short-time operation (Step) of a shutter.
□   10 - 19	MOVE operation	1-bit object for long-time operation (Move) of a shutter.
□   0 - 9	Scene extension:	1-byte object for recalling or for storing (light-) scenes 1 – 64).
□   0 - 9	Value transmitter:	1-byte object for transmission of, for example, dimming value telegrams (0 – 255).
□   0 - 9	Value transmitter [temp. / brightness]:	1-byte object for transmitting temperature values (0 - 40 °C) of brightness values (0 – 1500 lux) or 2-byte values (0 – 65535).
□   0 - 9	Switching 2-stage A	1-bit object for transmission of switching telegrams (ON, OFF).
□   10 - 19	Switching 2-stage B	1-bit object for transmission of switching telegrams (ON, OFF).
□   0 - 9	Value 2-stage A	1-byte object for transmission of, for example, dimming value telegrams (0 – 255).
□   10 - 19	Value 2-stage B	1-byte object for transmission of, for example, dimming value telegrams (0 – 255).
□   20	Switching:	1-bit object for transmission of an alarm message.
□   20	Value transmitter:	1-byte object for transmission of an alarm message.
□   20	Value transmitter:	2-byte object for transmission of an alarm message.
□   21	Disable function:	1-bit object for disabling the push button's keys or rockers
□   22	Switching:	1-bit object for switching the operation-LED.
□   23	Actual-temperature:	2-byte object for the display of the actual-temperature (room temperature), which is determined by the controller or controller extension. (possible range of values: -99,9 °C ... +99,9 °C / Measuring range of internal temperature sensor: 0 °C ... + 40 °C ±1 %)
□   24	External temperature sensor	2-byte object for coupling an external room temperature sensor or a controller extension (via „actual-temperature“ object). (possible range of values: -99,9 °C ... +99,9 °C)
□   25	Outside temperature sensor	2-byte object for coupling an outside temperature sensor to a controller or controller extension. The received value is used solely for the display. (possible range of values: -99,9 °C ... +99,9 °C)
□   26	Basic setpoint:	2-byte object for external setting of basic setpoint. Depending on the operating mode, the possible range of values is limited by the parameterized frost protection and/or heat protection temperature. The received value is mathematically rounded off to half °C!
□   27	Basic setpoint 2nd control circuit:	2-byte object for external setting of basic setpoint of the second control circuit with own setpoints. Depending on the control option, the possible range of values is limited by the parameterized frost protection and/or heat protection temperature. The received value is mathematically rounded off to half °C!

**Push button 2, 3, 5gang with room thermostat (RTR) and display flush-mounted**  
**756627xx, 756637xx, 756657xx**

Object description (continued)		
Objects:		
☐↔ 28	Operating mode switch-over:	1-byte object for switch-over of the controller's operating modes acc. to KONNEX.
☐↔ 28	Operating mode switch-over controller extension:	1-byte object for switch-over of the controller's operating modes acc. to KONNEX. The object is bi-directional so that the correct modes can also always be tracked on the extensions.
☐↔ 28	Comfort mode:	1-bit object for switch-over into the „comfort“ operating mode.
☐↔ 29	Standby mode:	1-bit object for switch-over into the „standby“ operating mode.
☐↔ 30	Night mode:	1-bit object for switch-over into the „night“ operating mode.
☐↔ 31	Frost/ heat protection:	1-bit object for switch-over into the „frost/heat protection“ operating mode.
☐↔ 32	Forced-control object operating mode:	1-byte object for superordinated forced control of the controller's operating modes acc. to KONNEX.
☐↔ 32	Forced-control operating mode	1-byte object for superordinated forced control of a controller's operating modes acc. to KONNEX. The object is bi-directional so that the correct modes can also always be tracked on the extensions.
☐↔ 33	Presence object:	1-bit object (bi-directional) which transmits the status of the presence key (if presence object is enabled, the presence key can be parameterized using the push button functions) on the bus or which allows to, for example, to couple a presence detector. (presence detected = „1“, presence not detected = „0“)
☐↔ 33	Presence object controller extension:	1-bit object (bi-directional), which transmits the status of the presence key of the controller extension on the bus when activated. (presence detected = „1“, presence not detected = „0“)
☐↔ 34	Windows status:	1-bit object for the coupling of window contacts. (window open = „1“, window closed = „0“)
☐↔ 35	Heating / cooling:	1-bit object for the switch-over between the control options „heating“ and „cooling“ In case of automatic switch-over the active control option can be transmitted
☐   36	Controller status:	1-byte object for general status feedback or 1-bit object for individual status feedback of parameterizable controller functions.
☐↔ 36	Controller status controller extension:	1-byte object for receiving the general status feedback of the main controller. This value is used to update the symbol and LED display of the extension.
☐   37	Indication heating:	1-bit object for the controller to indicate a request for heating energy (object value = „1“: energy request, object value = „0“: no energy request).
☐↔ 37	Indication heating controller extension:	1-bit object for feedback to the extension when the controller has requested heating energy (object value = „1“: energy request, object value = „0“: no energy request). This value is used to update the symbol displays of the extension.
☐   38	Indication cooling:	1-bit object for the controller to indicate a cooling energy request (object value = „1“: energy request, object value = „0“: no energy request).
☐↔ 38	Indication cooling controller extension:	1-bit object for feedback to the extension if the controller has requested cooling energy (object value = „1“: energy request, object value = „0“: no energy request). This value is used to update the symbol displays of the extension.

**Push button 2, 3, 5gang with room thermostat (RTR) and display flush-mounted**  
**756627xx, 756637xx, 756657xx**

Object description (continued)		
Objects:		
39	Disable controller operation:	1-bit object for disabling the local controller operation. (controller operation disabled = „1“, controller operation enabled = „0“)
40	Disable controller:	1-bit object for deactivating the controller (activating dew point operation). (controller deactivated = „1“, controller activated = „0“)
41	Disable additional stage:	1-bit object for deactivating the additional stage of the controller. (additional stage deactivated = „1“, additional stage activated = „0“)
41	2. disable control circuit:	1-bit object for deactivating the second control circuit. (2 <sup>nd</sup> control circuit deactivated = „1“, 2 <sup>nd</sup> control circuit activated = „0“)
42	Heating (control circuit 1):	1-byte object for the output of the continuous actuating variable used for the heating operation of the first control circuit.
42	Heating (control circuit 1):	1-bit object for the output of the switching actuating variable or PWM actuating variable used for the heating operation of the first control circuit.
42	Basic heating (control circuit 1)	1-byte object for the output of the continuous actuating variable for the basic heating operation of the first control circuit.
42	Basic heating (control circuit 1):	1-bit object for the output of the switching actuating variable or PWM actuating variable for the basic heating operation of the first control circuit.
42	Heating/cooling (control circuit 1)	1-byte object for the output of the continuous actuating variable for the heating or cooling operation of the first control circuit. (when actuating variables are output via a shared object)
42	Heating/cooling (control circuit 1)	1-bit object for the output of the switching actuating variable or PWM actuating variable alternatively used for the heating or cooling operation of the first control circuit. (with actuating variables output via a shared object)
42	Basic heating and cooling (control circuit 1):	1-byte object for the output of the continuous actuating variable either for the basic heating or basic cooling operation of the first control circuit. (if actuating variables are output via a shared object)
42	Basic heating and cooling (control circuit 1):	1-bit object for the output of the switching actuating variable or PWM actuating variable either for the basic heating or basic cooling operation of the first control circuit. (if actuating variables are output via a shared object)
43	Additional heating (control circuit 1)	1-byte object for the output of the continuous actuating variable for the additional heating operation of the first control circuit.
43	Additional heating (control circuit 1)	1-bit object for the output of the switching actuating variable or PWM actuating variable used for the additional heating operation of the first control circuit.
43	Additional heating and cooling (control circuit 1)	1-byte object for the output of the continuous actuating variable either for the additional heating or cooling operation of the first control circuit. (if actuating variables are output via a shared object)
43	Additional heating and cooling (control circuit 1)	1-bit object for the output of the switching actuating variable or PWM actuating variable either for the heating or cooling operation of the first control circuit. (if actuating variables are output via a shared object)
44	Cooling (control circuit 1):	1-byte object for the output of the continuous actuating variable used for the cooling operation of the first control circuit.
44	Cooling (control circuit 1):	1-bit object for the output of the switching actuating variable or PWM actuating variable used for the cooling operation of the first control circuit.
44	Basic cooling (control circuit 1)	1-byte object for the output of the continuous actuating variable for the basic cooling operation of the first control circuit.

**Push button 2, 3, 5gang with room thermostat (RTR) and display flush-mounted**  
**756627xx, 756637xx, 756657xx**

**Object description (continued)**

**Objects:**

44	Basic cooling (control circuit 1)	1-bit object for the output of the switching actuating variable or PWM actuating variable for the basic cooling operation of the first control circuit.
45	Additional cooling (control circuit 1)	1-byte object for the output of the continuous actuating variable for the additional cooling operation of the first control circuit.
45	Additional cooling (control circuit 1)	1-bit object for the output of the switching actuating variable or PWM actuating variable for the additional cooling operation of the first control circuit.
46	Heating (control circuit 2):	1-byte object for the output of the continuous actuating variable for the heating operation of the second control circuit.
46	Heating (control circuit 2):	1-bit object for the output of the switching actuating variable or PWM actuating variable for the heating operation of the second control circuit.
46	Heating (control circuit 1):	1-byte object (pulse width modulated variable signal) for status feedback of the actuating variable value for heating. (only for one control circuit)
46	Basic heating (control circuit 1)	1-byte object (pulse width modulated variable signal) for status feedback of the continuous actuating variable value for basic heating. (only for one control circuit)
47	Additional heating (control circuit 1)	1-byte object (pulse width modulated variable signal) for status feedback of the actuating variable value for additional heating. (only for one control circuit)
48	Cooling (control circuit 2):	1-byte object for the output of the continuous actuating variable for the cooling operation of the second control circuit.
48	Cooling (control circuit 2):	1-bit object for the output of the switching actuating variable or PWM actuating variable for the cooling operation of the second control circuit.
48	Cooling (control circuit 1):	1-byte object (pulse width modulated variable signal) for status feedback of the continuous actuating variable value for heating. (only for one control circuit)
48	Basic cooling (control circuit 1)	1-byte object (pulse width modulated variable signal) for status feedback of the continuous actuating variable value for basic cooling. (only for one control circuit)
49	Additional cooling (control circuit 1)	1-byte object (pulse width modulated variable signal) for the status feedback of the actuating variable value for additional cooling. (only for one control circuit)
50	Set temperature:	2-byte object for the output of the current temperature-setpoint of the first control circuit. Depending on the control option, the possible range of values is limited by the parameterized frost protection and/or heat protection temperature.
50	Set temperature	2-byte object for receiving the current temperature-setpoint of a controller. The received value is, if parameterized, visible in the display of the extension.
51	Set temperature 2 <sup>nd</sup> control circuit	2-byte object for the output of the current temperature-setpoint of the first control circuit. Depending on the control option, the possible range of values is limited by the parameterized frost protection and/or heat protection temperature.



**Object description (continued)**

**Objects:**

□   52	Current setpoint shifting:	1-byte object for giving feedback on the current setpoint shifting. $x \leq 0 \leq y$ (0 = no active shifting); integral numbers The possible range of values (x to y) is fixed within the preset limits of the setpoint (parameterizable) in combination with the step value (0.5 °C)
□   52	Current setpoint shifting controller extension:	1-byte object for receiving the current basic setpoint shifting of a controller. $x \leq 0 \leq y$ (0 = no active shifting); integral numbers The possible range of values (x to y) is fixed within the preset limits of the setpoint (parameterizable) in combination with the step value <u>on the controller</u> (0.5 °C)
□   53	Presetting setpoint shifting	1-byte object for setting a basic setpoint shifting, e.g. via a controller extension. $x \leq 0 \leq y$ (0 = no active shifting); integral numbers The possible range of values (x to y) is fixed within the preset limits of the setpoint (parameterizable) in combination with the step value (0.5 °C) In case the limits of the value range are exceeded by the preset external value, the controller inside the push button with RTR and display will automatically reset the received value to the minimum and maximum limits.
□   53	Presetting setpoint shifting controller extension:	1-byte object for presetting a basic setpoint shifting, e.g. via a controller. $x \leq 0 \leq y$ (0 = no active shifting); integral numbers Value object 52 + 1 (increase step value) Value object 52 + 1 (decrease step value) Thus the possible range of values (x to y) is fixed within the preset limits of the setpoint (parameterizable) in combination with the step value <u>on the controller</u> (0.5 °C)
□   54	Time:	3-byte object for receiving the current time via the bus.
□   55	Disable function:	1-bit object for disabling the room temperature regulator timer.
□   56 – 63	Scene output 1 – 8:	1-bit object for transmission of up to eight switching commands of one scene.
□   56 – 63	Scene output 1 – 8:	1-byte object for transmission of up to eight value commands of one scene.
□   56 – 63	Scene output 1 – 8:	1-bit object for transmission of up to eight shutter long-term commands of one scene.
□   64	Scene extension:	1-byte object for external recall or storing of the 8 internally stored scenes.
□   65	Switching:	1-bit object for transmission of a switching telegram from the temperature control system (temperature alarm 1 / lower temperature value).
□   66	Switching:	1-bit object for transmission of a switching telegram from the temperature control system (temperature alarm 2 / upper temperature value).
□   67 - 76	Status	1-bit object for separate status-LED control of a key or rocker.

## Scope of functions

### Push button functions:

#### • General

- Free allocation of the switching / pushing, dimming, shutter, light-scene extension / light-scene recall, 1-byte value transmitter, 2-byte value transmitter, two telegrams, operating mode switch-over\* and setpoint shifting functions to the keys.
- Free allocation of the switching, dimming, shutter, two telegrams and operating mode switch-over functions to the rockers.
- If the controller extension function is enabled, the controller extension function is parameterizable. This function allows the operating mode switch-over according to KONNEX, the control of the presence function as well as the basic setpoint adjustment of a room temperature regulator.
- Status indication possible via 4 (2 gang), 6 (3 gang) or 10 (5 gang) red LED's. The status indication can also take place via separate status objects.
- Even if „no function“ is assigned to the rockers or keys, the status-LED's can still be controlled via objects
- Disable object is available for disabling individual rockers (polarity of the disable object is adjustable)

*\*: Only if controller extension is deactivated!*

#### • „Switching / pushing“ function

- Command by pushing or releasing the key is adjustable (ON, OFF, TOGGLE, no function)
- Single-surface operation for rocker function possible (Only if „command when pressing the rocker = left = toggle, right = toggle“)
- Function of status-LED (key function) or status indication (rocker function) is parameterizable

#### • „Dimming“ function

- Time between dimming and switching and dimming increments is adjustable
- Telegram repetition and stop telegram transmission possible
- Single-surface operation with rocker functions possible (only if „command when pressing the rocker = left = toggle, right = toggle“)
- Function of status-LED for (key function) or status indication (rocker function) is parameterizable

#### • „Shutter“ function

- Adjustable key function (UP, DOWN, TOGGLE). Single-surface operation possible with shutter key function = TOGGLE.
- Operation concept parameterizable (STEP – MOVE – STEP or MOVE – STEP)
- Time adjustable between short-time and long-time operation (only for STEP – MOVE – STEP)
- Adjustable Lamella adjustment time (time during which a MOVE command can be terminated by releasing the key).
- Function of status-LED (key function) or status indication (rocker function) is parameterizable

#### • „Value transmitter 1-byte / light-scene extension/ recall“ function (only for key function!)

- Parameterizable value transmitter (1-byte) or light-scene recall with / without memory function
- Value adjustment via long key-press possible
- Parameterizable function of the status-LED
- With light-scene recall, internal scenes can also be recalled.

#### • „Value transmitter 2-byte“ function (only for key function!)

- Parameterizable brightness value transmitter, temperature value transmitter and 2-byte value transmitter key functions
- Value adjustment via long key press possible
- Parameterizable status-LED function

#### • „Two telegrams“ function

- Transmission of two different switching or value telegrams via one key-press
- Switching command (ON, OFF, TOGGLE) or value (0...255) parameterizable
- Adjustable time delay between the telegrams
- Status-LED function parameterizable



**Room temperature regulator functions:**

• **General**

- 5 operating modes: comfort, standby, night, frost/heat protection and controller disable
- Operating modes switch-over via 1-byte object according to KONNEX or individual 1-bit objects.
- Display of room temperature regulator information via an integrated display
- Local programming mode possible. This one can be activated or deactivated.
  - „No operation“: 'normal operation' and local operation of room temperature regulator by pressing the display keys for shifting the basic setpoint.
  - „Limited operation“: Switch-over into programming mode possible → 'normal operation' incl. setpoint shifting and operating mode switch-over and adjustments of different setpoints for heating and/or cooling.
  - „Complete operation“: Full access to the device with local control. In addition to the Limited operation it allows the user to have access to the room temperature timer (activating/deactivating timer and changing switching programs), display contrast adjustment and key lock (activating/deactivating the lock)

• **Heating/cooling system**

- Control options: „heating“, „cooling“, „heating and cooling“ each with or without additional stage.
- Up to two control circuits with optional different temperature-setpoints and shared operating mode switch-over possible.  
(with two control circuits only „heating“ or „cooling“ can be activated, no additional stage!)
- PI control (continuous or switching PWM) or 2-point control (switching) adjustable as control algorithms.
- Continuous (1-byte) or switching (1-bit) actuating variable output.
- Control parameter for PI controller (if desired: proportional range, reset-time) and 2-point controller (hystereses) adjustable.

• **Setpoints**

- Each operating mode can be assigned its own temperature-setpoints (for heating and/or cooling).
- The setpoints for the additional stage are derived via a parameterizable stage offset from the values of the basic stage.
- Temporary setpoint shifting or permanent setpoint shifting via local control on the device or via communication objects possible (parameterizable scaling of setpoint shifting).

• **Functions**

- Automatic or object oriented switch-over between „heating“ and „cooling“.
- Optionally, the controller operation can be disabled via an object.
- Parameterizable duration of the comfort mode extension.
- Complete (1-byte) or partial (1-bit) status information parameterizable and transmissible on the bus via an object.
- Deactivating the control, the additional stage or the second control circuit via different objects possible.

• **Room temperature measurement**

- Internal and external room temperature sensor available.
- Parameterizable internal to external determination of measured value with one control circuit and enabled external sensor.
- If using two control circuits the actual-temperature value of the second circuit will be determined by the external sensor.
- Measurement period of external temperature sensor is adjustable.
- The actual and set temperature can be output on the bus if a parameterizable deviation is detected (also periodically).
- The room temperature measurement (actual value) can be adjusted separately for the internal and external sensor via parameter.
- Frost/heat protection switch-over via window status (delayed analysis possible) and automatic frost protection.
- Temperature alarm within preset limits possible. Telegram activation via two separate objects.

# Push button 2, 3, 5gang with room thermostat (RTR) and display flush-mounted

## 756627xx, 756637xx, 756657xx

### • Actuating variable output

- Separate or combined actuating variable output via one or two objects in „heating and cooling“ mode
- Normal or inverted actuating variable output parameterizable
- Automatic transmission and cycle-time for actuating output parameterizable

### • Room temperature timer

- Time and day-of-week depending operating mode control with up to 28 different switching times.
- Can be activated or deactivated via local control in programming mode.
- In addition, the room temperature timer can be disabled via bus.

### Controller extension functions:

- Alternatively to the function as room temperature regulator, the extension mode can be activated.  
→ Activation of another push button with RTR and display parameterized to function as a room temperature regulator.
- Full control (operating modes, presence functions and setpoint shifting)
- Full-featured display of the controller status on the display of the extension (heating /cooling indication, setpoint shifting, set or room temperature and current operating mode)
- Room temperature measurement on the extension possible.
- Local programming mode possible. This one can be activated or deactivated.
  - „No operation“: Display keys without function
  - „Complete operation“: Full access to the device with local control. Allows the user to have access to the contrast setting of the display and to the key lock (activating/deactivating the lock).

### Scene functions:

- 8 independent internal scenes
- Each scene controls up to 8 objects, i.e. eight different commands are transmissible.
- Selectable data types include switching (On / Off), dimming value (0...255 / 0...100%) or long-time shutter commands (Up / Down) that are parameterizable per scene and scene object.
- The scenes can be recalled or stored via an extension object.
- Recall of internal scenes also possible without extension object via push button control.

### Push button general:

- Automatic switch-off of the operation-LED is parameterizable. Alternatively, the operation-LED is switchable via a separated object or permanently switched on.
- Alarm message following the unplugging of the device from the flush-mounted bus coupler is parameterizable (1-bit or 1-byte)
- The current time as well as the external temperature can be shown on the display.

**Table of Contents I**

	Page
<b>1. General functions</b>	<b>29</b>
1.1 Enabling the push button, scene, timer, room temperature regulator and controller extension functions	29
1.2 Alarm function	29
1.3 Light-emitting period of the actuation indicator	30
1.4 Programming mode / local control	30
1.4.1 Local control in normal operation	32
1.4.2 Local control in programming mode	33
1.4.2.1 "Operating mode switch-over" submenu	34
1.4.2.2 "Temperatures heating" or „Temperatures cooling“	35
1.4.2.3 "Raumtemperatur-Schaltuhr" submenu	40
1.4.2.4 Activating and deactivating the key lock	41
1.4.2.5 Setting the display contrast	42
1.4.2.6 Overall overview of the programming menus	43
<b>2. Display</b>	<b>45</b>
2.1 Basic function	45
2.2 Symbols	46
2.3 Display data during a programming operation, initialisation or failure	47
<b>3. Push button functions:</b>	<b>48</b>
3.1 Rocker layout	48
3.2 Operation-LED	49
3.3 Rocker functions	50
3.3.1 Rocker actuation	51
3.3.1.1 "no function" function	51
3.3.1.2 "Switching / pushing" function	51
3.3.1.3 "Dimming" function	51
3.3.1.4 "Shutter" function	52
3.3.1.4 "Two telegrams" function	53
3.3.2 Key actuation	54
3.3.2.1 "No function" function	54
3.3.2.2 "Switching / pushing" function	54
3.3.2.3 "Dimming" function	54
3.3.2.4 "Shutter" function	55
3.3.2.5 "Value transmitter 1-byte" and „Value transmitter 2-byte“ function	56
3.3.2.6 "Light-scene extension/recall" function	58
3.3.2.7 "Room temperature timer operation" function	59
3.4 Disable function for push button application	60

**Table of Contents II**

	Page
<b>4. Room temperature regulator functions</b>	<b>61</b>
4.1 Operating modes	61
4.1.1 Operating mode switch-over	62
4.1.2 Notes on the operating modes	69
4.1.3 Controller status	72
4.2 Control options and control option switch-over	73
4.3 Room temperature regulator and actuating variables	75
4.3.1 Control algorithms and calculation of actuating variable	75
4.3.2 Adapting the control algorithms	80
4.3.2.1 Adapting the PI control	80
4.3.2.2 Adapting the 2-point control	82
4.3.3 Actuating variable output	83
4.3.3.1 Actuating variable objects	83
4.3.3.2 Automatic transmission	84
4.4 Temperature setpoints	85
4.4.1 Setpoint presettings in the ETS	85
4.4.1.1 Setpoints for the „heating“ control option	86
4.4.1.2 Setpoints for the „cooling“ control option	87
4.4.1.3 Setpoint for the „heating and cooling“ control option	88
4.4.2 Adjusting the setpoints	91
4.4.2.1 Adjusting basic temperature and set-temperatures for comfort, standby and night mode	91
4.4.2.2 Basic setpoint shifting	93
4.4.3 Transmitting the set-temperature	95
4.5 Room temperature measurement	95
4.5.1 Temperature detection and determination of measured value	96
4.5.2 Adjusting the measured values	97
4.5.3 Transmitting the actual-temperature	97
4.6 Disable functions of the room temperature regulator	98
4.6.1 Disabling control	98
4.6.2 Disabling controller operation	98
4.7 Room temperature timer	99
4.8 Temperature alarm	102
4.9 Valve protection	102
<b>5. Controller extension function</b>	<b>103</b>
5.1 General	103
5.2 Push button functions of the controller extension	103
5.2.1 "Normal operating mode switch-over" controller extension function	103
5.2.2 "Forced operation switch-over" controller extension function	104
5.2.3 "Presence key" controller extension function	104
5.2.4 "Setpoint shifting" controller extension function	105
5.3 Display functions of the controller extension	106
5.4 Overview of the communication objects	107
5.5 Behaviour of the controller extension after a reset	108
<b>6. Scene function</b>	<b>108</b>
6.1 Scene definition	108
6.2 Scene recall / scene memory	109
<b>7. Messages during a programming operation</b>	<b>110</b>

## Functional description

### 1. General functions

#### 1.1 Enabling the push button, scene, room temperature regulator and controller extension functions

The push button, scene, room temperature regulator and controller extension functions have to be considered separately. If required, these individual components can optionally be activated or deactivated. For that purpose the „push button function“, „scene function“, „room temperature regulator function“ or „controller extension function“ parameters in the „push button xgang“ parameter branch have to be set to „switched on“. The assigned parameters and objects may only be activated and changed if function is activated. The controller extension function can only be activated as an alternative to the room temperature regulator.

It must be pointed out that by deactivating individual functions the parameterizable scope of function of the push button's rockers or keys is dynamically adapted by the ETS plug-in.

It is, for example, not possible to parameterize switching, dimming, shutter or value transmitter functions if the push button function is switched off. If, however, the room temperature regulator function is deactivated, the rockers cannot be set to operate the internal controller.

#### 1.2 Alarm function

If the push button with RTR and display is unplugged from the flush mounted bus coupler, a message in the form of an ON or OFF telegram or a value telegram may be transmitted via the „alarm message“ object. Alternatively, this telegram can be suppressed via the „alarm function after pulling off the application module „ = „disabled“ (default) ETS parameter setting.

##### a) Parameter „reset value“ = „no“ (default)

By unplugging the push button from the bus coupler an alarm telegram is transmitted with the alarm value corresponding to the set parameter value (switching value „1“ or „0“ with switching telegram or value „0...255“).

After replugging the push button will be operational again after the initializing phase (display indication „In“). The value of the alarm object is always reset to „0“ (for the 1-bit switching value and 1-byte value) but it is not actively transmitted on the bus. It is not necessary to reset the alarm telegram externally. An external write access to the alarm object will overwrite the object value. This one, however, will be overwritten by the parameterized or preset values when unplugging or replugging the push button.

In case of a bus voltage failure, a previously transmitted alarm message is stored in non-volatile memory. A stored alarm message will be transmitted anew in case of a return of bus voltage if the push button is not plugged-in during the return of bus voltage.

##### b) Parameter „reset value“ = „yes“

By unplugging the push button from the bus coupler, an alarm telegram is transmitted with the alarm value corresponding to the set parameter value (switching value „1“ or „0“ with switching telegram or value „1...255“)

After replugging the push button is operational again after the initializing phase (display indication „In“). During the initialisation phase the value of the alarm object is reset to the inverted object value for the 1-bit switching value or to the value „0“ for the 1-byte value and actively transmitted on the bus. It is not necessary to reset the alarm telegram externally. An external write access to the alarm object will overwrite the object value. This one, however, will be overwritten by the parameterized or preset values when unplugging or replugging the push button.

In case of a bus voltage failure, a previously transmitted alarm message is stored in non-volatile memory. A stored alarm message will be transmitted anew in case of a return of bus voltage if the push button is not plugged-in. In case the push button is plugged-in during the return of bus voltage, the alarm will be reset by the transmission of the inverted object value for the 1-bit switching value or the value „0“ for the 1-byte value

Note: The „alarm message“ object can only be linked to one group address! This object can only be read-out if the push button is plugged on (set R flag!).

### 1.3 Light-emitting period of the actuation indicator

For all push button functions with key actuation, the status-LED of a key can be parameterized to function as an actuation indicator. Only in this case the LED will illuminate for the duration preset by the „light duration of status-LED at operation indication“ parameter in the „push button xgang“ parameter branch. Optionally, 1 sec, 2 sec or 3 sec (default) can be parameterized.

### 1.4 Programming mode / local control

The push button with RTR and display features a programming mode directly on the device. Thus, besides a parameterization via the ETS plug-in, it is possible to locally configure different functions or to preset miscellaneous temperature values or switching times. The two display keys left and right of the display allow to switch-over into the programming mode or to navigate the menu.

The „operation via display buttons“ parameter in the „push button xgang“ parameter branch determines the possible scope of a local control or configuration in the programming menu:

- "No operation":

'Normal operation' and local control of room temperature regulator by pressing the display keys in order to shift the basic setpoint. Programming modes cannot be activated.

- "Limited operation":

Switch-over in programming mode possible → 'normal operation' incl. setpoint shifting and switch-over of operating mode and adjustments of different setpoints for heating and/or cooling.

- „Complete operation“:

Full access to the device with local control. In addition to the Limited operation it allows the user to have access to the room temperature timer (activating/deactivating timer and changing switching programs), display contrast adjustment and key lock (activating/deactivating the lock)

Note:

- Some of the programming menu functions (e.g. the readjusting setpoints, presetting the room temperature timer) are only available, if access to these components have been enabled in the ETS plug-in or if these functions are available in the first place (example: the „heating only“ control option does not feature the settings for the cooling operating mode).  
In addition, the operation of the controller (display keys) might be disabled. It is possible to set parameter values in the ETS plug-in that determine whether the disabling of the controller operation takes place throughout or whether it is object controlled ([cf.. „4.6.2 Disabling controller operation“](#))
- In its function as a controller extension, control via the display keys is only limited. Access to the programming menu via „Complete operation“ allows only to set the display contrast and to activate/deactivate the key lock. The display keys used for the indication and shifting of the basic setpoint in 'normal operation' are deactivated.

# Push button 2, 3, 5gang with room thermostat (RTR) and display flush-mounted

## 756627xx, 756637xx, 756657xx

The programming menu is navigated via the two display keys located left and right of the display and via the push button's rockers. The following controls are available...

### Display key functions:

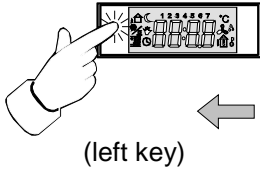

Selecting a menu item by navigating to the left or adjusting a value (e.g. temperature value or switching time) in negative direction. During 'normal operation' (no programming mode is activated) the setpoint can be shifted via this key (does not apply to the controller extension)

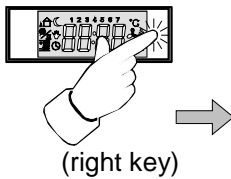

Selecting a menu item by navigating to the right or adjusting a value (e.g. temperature value or switching time) in positive direction. During 'normal operation' (no programming mode is activated) the setpoint can be shifted via this key (does not apply to the controller extension)

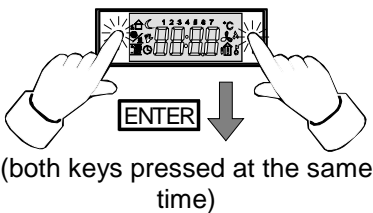

Accessing the programming menus (pressing the keys for at least 3 sec) or confirming a preset value such as setpoint or switching time (pressing the keys for at least 1 sec)

### The push button's rocker or key functions:

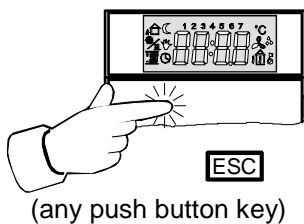

The programming mode or the selected menu (return into the higher-level menu) may be left by pressing any push button key (not the display keys). The escape command will discard any readjusted value. In this case the readjusted value will not be accepted in the memory of the device.

The control will automatically execute an escape command, if no keys are pressed for approx. 20 sec.

#### Note:

If settings are accepted by pressing „Enter“ (e.g. activating/deactivating functions), the last setting will be accepted into the memory of the device even after an escape command.

A temperature setpoint shifting via the display keys in normal operation will also be accepted after an escape command.



#### 1.4.1 Local control in normal operation

The device will run in normal operation if the programming mode is not activated. Depending on the parameterization (cf. „2.2 Display data in normal operation“), the standard display is the current room temperature (default) or alternatively the external temperature, the set-temperature or the time.

By pressing any one of the display keys or one of the function keys that are parameterized in the ETS as „setpoint shifting“ the set-temperature for the activated operating mode becomes visible in the display.

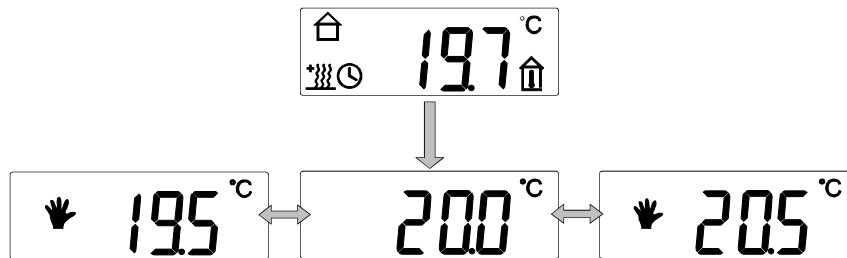

Pressing the right or left display key or the appropriate function key allows to increase or decrease the set- temperature in 0.5 °C increments. This setpoint shifting (temperature offset of basic temperature) can be preset for each mode and optionally accepted when switching over to another operating mode (e.g. comfort mode → standby mode) affecting all of the controller's operating modes. More information on presetting or shifting the basic set-temperature can be found in chapter „4. Room temperature regulator functions“.

The hand symbol „☞“, on the display indicates that a basic setpoint shifting has been set. The set temperature value is instantly accepted as the new setpoint.

In case the setpoint shifting was set via the display keys, the display can be switched back to default by using the escape command (pressing any of the push button's keys / not a display key).

In case the setpoint shifting was preset via a function key, the actuation of another function key will cause the display to switch. In this case, however, the stored key function will also be executed.

If no other keys have been pressed for approx. 20 sec. The display will also switch back in both cases.

#### Notes:

- Following the return of bus voltage the controller always runs in normal operation!
- It has to be pointed out that the display keys or the function keys that are parameterized as „setpoint shifting“ are influenced by a push button disable function or by disabling the controller. While disabling is activated („⊞“, symbol is visible on display) any actuation of the keys, if applicable, will be ignored.
- If the push button functions as a controller extension, the display keys for the display and shifting of the basic setpoint will be deactivated.



**Push button 2, 3, 5gang with room thermostat (RTR) and display flush-mounted**  
**756627xx, 756637xx, 756657xx**

1.4.2 Local control in programming mode

In programming mode it is possible to activate or deactivate different functions or to change settings. That way the operating mode can be switched, the temperature setpoints can be changed, the room temperature timer can be set or other basic settings can be made.

Note:

Basically, some functions or settings may not be accessible due to the parameterization of the device in the ETS plug-in!

More information on settings or operating modes and room temperature timer functions can be found in chapter „4. Room temperature timer functions“

The following explains the individual main menu items:

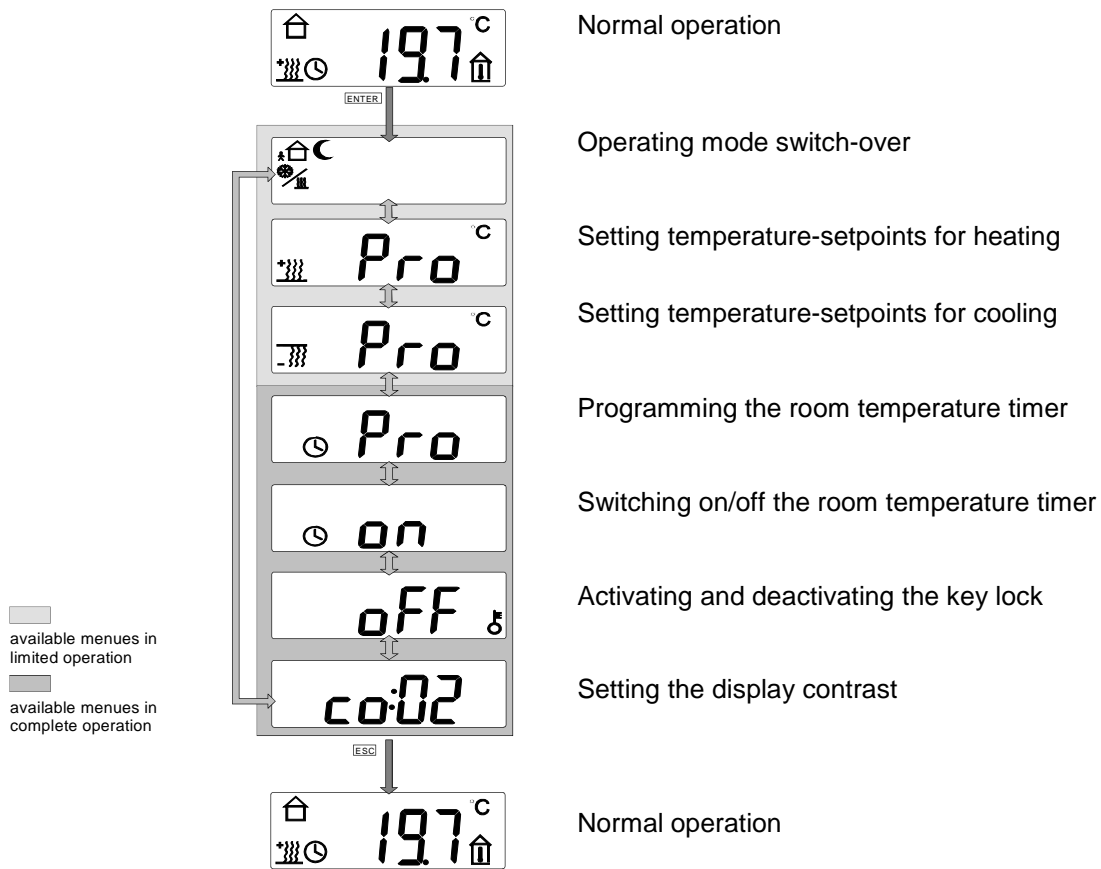

The programming mode is accessed by pressing both display keys for approx. 3 sec. This will activate the main menu. The display keys can be used here to navigate between the individual menu items. The corresponding submenus to the selected menu can be accessed by pressing both display keys ("Enter").

The „temperatures heating (Pro )“ and „temperatures cooling (Pro )“ menus are visible separately or together depending on the control option parameterized in the ETS plug-in. In „heating and cooling“ mixed-mode operation, too, the temperature values for cooling and thus the menu may be separately disabled!

The room temperature timer submenu also depends on the parameterization and may be suppressed if the functions have not been enabled in the ETS plug-in or if the timer has been deactivated via the programming menu or via a correspondingly projected function key.

The return into the normal operation takes place by pressing any of the push button's keys (not display key) or if there has not been any input for approx. 20 sec.

# Push button 2, 3, 5gang with room thermostat (RTR) and display flush-mounted

## 756627xx, 756637xx, 756657xx

### 1.4.2.1 "Operating mode switch-over" submenu

The „operating mode switch-over“ submenu is opened from the main menu via the „Enter“ command. A call will not be possible if a higher-priority mode (e.g. window contact / presence detector) or the KONNEX forced object is still active!

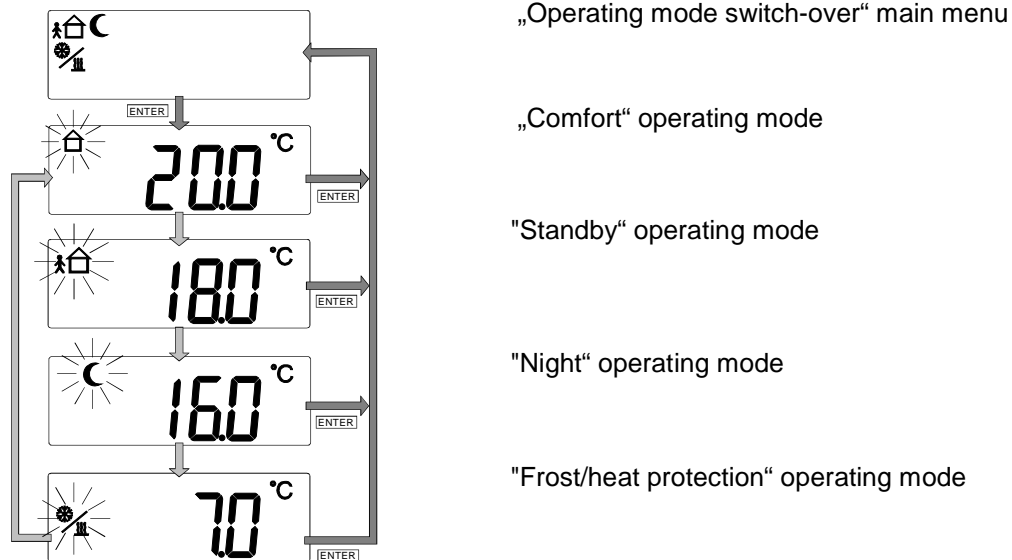

The operating mode selected via the display keys will be accepted by the „Enter“ command. The display will subsequently switch back into the main menu.

The temperature values displayed for the different operating modes represent the temperature setpoints, which can be temporarily expected for each selected mode. In consideration of the current control option of the room temperature regulator and the possibly adjusted setpoint shifting, those setpoints are displayed which the controller has accepted as new setpoints following a change of the operating mode. These temperature values can be changed anytime later during the ongoing operation of the controller by local control or by a basic setpoint-shifting via the object.

**Note:** The operating mode which was activated after the return of bus voltage is selectable via the „operation mode after reset“ parameter in the „room temperature regulator function / functionality“ parameter branch! It is always the normal operation, which will be activated following the return of bus voltage!

# Push button 2, 3, 5gang with room thermostat (RTR) and display flush-mounted 756627xx, 756637xx, 756657xx

## 1.4.2.2 "Temperatures heating" or „temperatures cooling“ submenu

The „temperatures heating“ or „temperatures cooling“ submenus are opened from the main menu via the „Enter“ command. Depending on the control option set in the ETS plug-in, these menus are visible and they may be available separately or together (while in mixed-mode operation). In mixed-mode operation it is possible to disable the temperature setpoints for cooling when using local control by setting the „modification of the setpoints 'cooling'„ parameter in the „room temperature regulator function / set point values“ parameter branch to „deactivated“

The procedure for the heating and cooling temperature values is identical making it unnecessary to describe the menu structure again. The procedure does not differ for the different temperatures either.

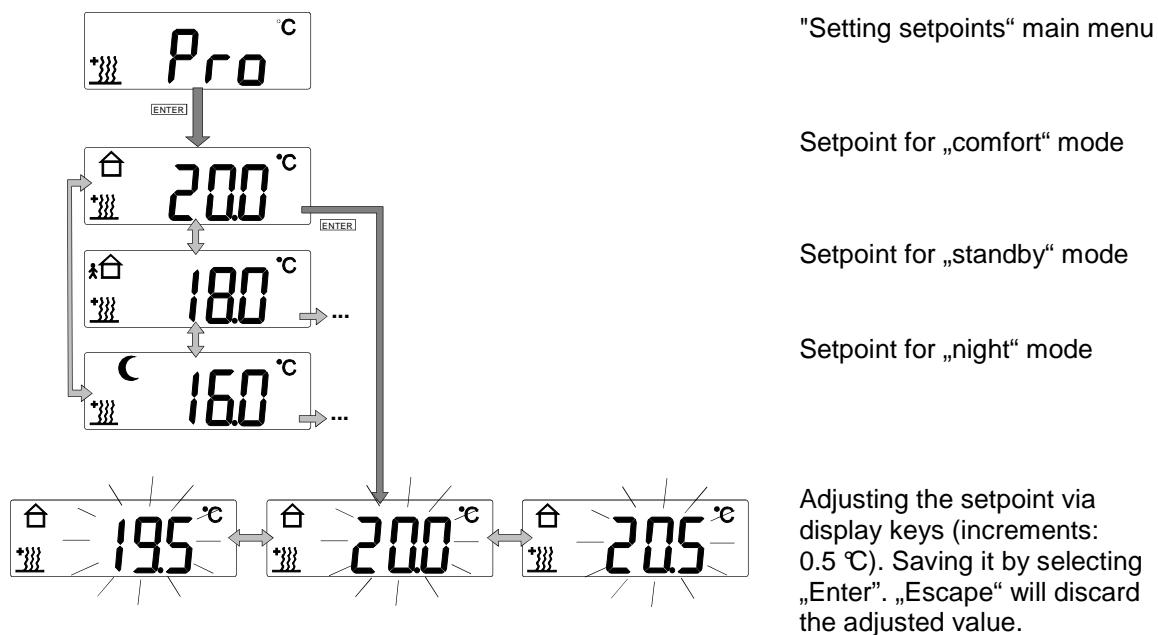

Once a setpoint has been set and the input has been confirmed by an Enter command, the operating mode associated with the adjusted setpoint will be accepted as the active mode. This, however, is only the case if no higher-priority mode (e.g. window contact / presence detector) is activated or if the KONNEX forced object is not activated!

### Example 1:

- 1 – Comfort mode „“ is active via push button operation
- 2 – Switching into the programming mode
- 3 – Adjusting the setpoint for the night mode „“
- 4 – Confirming the new setpoint (Enter) – Switching into normal operation
- 5 – Night mode is activated „“!

### Example 2:

- 1 - Presence detector is active (comfort mode „“)
- 2 – Switching into programming mode
- 3 – Adjusting the setpoint for the night mode „“
- 4 – Confirming the new setpoint (Enter) – Switching into normal operation
- 5 – Comfort mode „“ is still active!!



The operating mode can only be switched if the associated setpoint in the ETS plug-in is enabled for local adjustment (cf. „4.4 Temperature setpoints“).

If more setpoints are to be set, the steps described here have to be followed again.

**Push button 2, 3, 5gang with room thermostat (RTR) and display flush-mounted**  
**756627xx, 756637xx, 756657xx**

Setting the temperature setpoints:















The setpoints for the

- „comfort ,
- „standby , and
- „night , operating modes can be reset.

Depending on the control option enabled in the ETS plug-in, up to 6 different values are available for setting the setpoints.

It has to be pointed out that some setpoints in the ETS have not been freed for local control. Thus they can only be seen in the display window and cannot be changed (cf. „4.4. Temperature setpoints“)! Also, in case the second control circuit has its own setpoints, only the temperature values of the first control circuit are to be set in the programming mode.

The following table shows the values to be set:

activated operating mode	parameterized control option			
	Heating and cooling			
	Heating	Cooling	for heating	for cooling
Comfort 	 e.g. <b>23.0</b> °C Comfort set-temperature = Basic setpoint	 e.g. <b>27.0</b> °C Comfort set-temperature = Basic setpoint	 e.g. <b>23.0</b> °C Comfort set-temperature = Basic setpoint t – ½ Dead band symmetrical for Dead band / = Basic setpoint assymmetrical for Dead band	 e.g. <b>27.0</b> °C Comfort set-temperature = Basic setpoint t + ½ Dead band symmetrical for Dead band / = basic setpoint + Dead band assymmetrical for Dead band
Standby 	 e.g. <b>21.0</b> °C Standby set-temperature	 e.g. <b>29.0</b> °C Standby set-temperature	 e.g. <b>21.0</b> °C Standby set-temperature	 e.g. <b>29.0</b> °C Standby set-temperature
Night 	 e.g. <b>19.0</b> °C Night set-temperature	 e.g. <b>31.0</b> °C Night set-temperature	 e.g. <b>19.0</b> °C Night set-temperature	 e.g. <b>31.0</b> °C Night set-temperature

# Push button 2, 3, 5gang with room thermostat (RTR) and display flush-mounted

## 756627xx, 756637xx, 756657xx

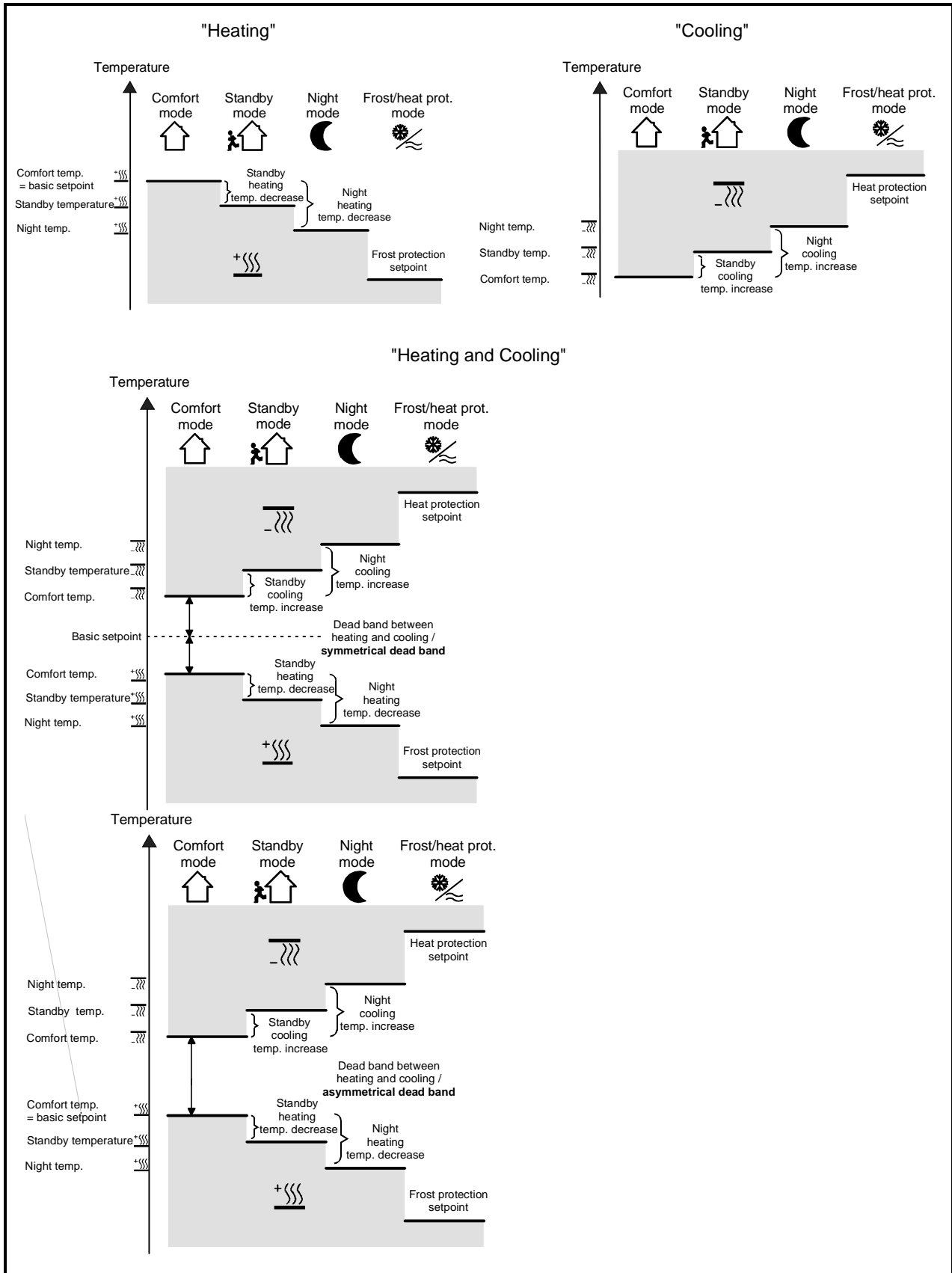

**Push button 2, 3, 5gang with room thermostat (RTR) and display flush-mounted**  
**756627xx, 756637xx, 756657xx**

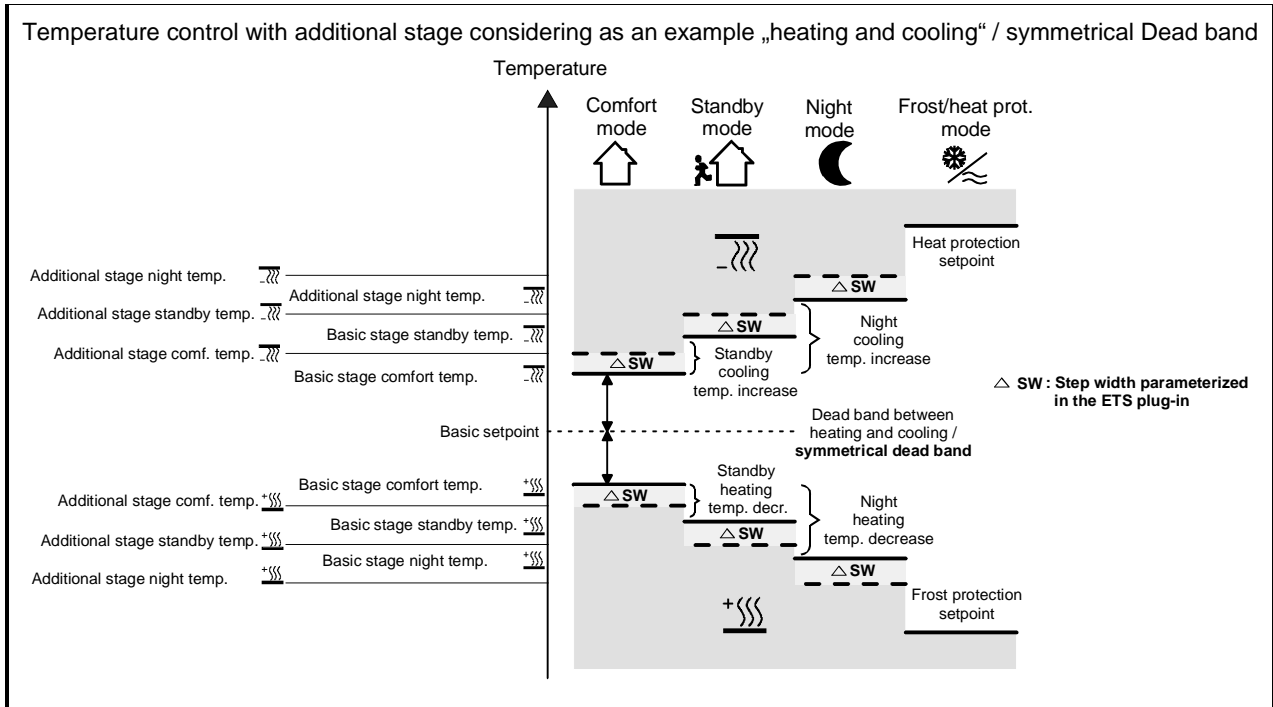

# Push button 2, 3, 5gang with room thermostat (RTR) and display flush-mounted

## 756627xx, 756637xx, 756657xx

6 temperature setpoints can be set in the „heating and cooling“ control option if enabled in the ETS plug-in. Depending on the temperature decrease, increase or Dead band parameterized in the ETS, all temperature setpoints are derived from the basic set-temperature.

It must be pointed out that changing the set-temperature for heating in the comfort mode will also adjust all other set-temperature values!

The Dead band (temperature zone for which there is neither heating nor cooling) is the difference between the set-temperatures for „heating“ and „cooling“ in the comfort mode. The following applies:

$$T_{\text{Comfort Set Cooling}} - T_{\text{Comfort Set Heating}} = T_{\text{Dead band}}; T_{\text{Comfort Set Cooling}} \geq T_{\text{Comfort Set Heating}}$$

Important:

- If the Dead band is symmetrical, the basic setpoint is indirectly set via the comfort temperature for heating. The basic setpoint is not shown on the display even with local control!
- Changing the comfort set-temperature for cooling allows the adjustment of the Dead band. An adjustment of the Dead band with a symmetrical dead band position will result in a shifting of the comfort set-temperature for heating and thus of all other temperature setpoints. With an asymmetrical dead band position, an adjustment of the comfort set-temperature for cooling will only shift the temperature setpoints for cooling. It is possible to shift the Dead band to 0 °C via local control ( $T_{\text{Comfort Set Cooling}} = T_{\text{Comfort Set Heating}}$ ). In this case there will be neither heating nor cooling if the measured room temperature equals the comfort set-temperatures.

The set-temperatures for „standby“ and „night“ are derived from the comfort set-temperatures for heating or cooling. The temperature increase (for cooling) and the temperature decrease (for heating) of both operating modes can be preset in the ETS plug-in.

It is possible to adjust the set-temperatures for „standby“ and „night“ via local control in the programming mode independent of the values for the temperature increase/decrease, which were originally parameterized in the ETS.

In this case, the adjustment of the basic set-temperature or the Dead band, the standby or night set-temperatures will always shift together with the temperature increase/decrease resulting from the local control. After the reprogramming with the ETS, the originally parameterized values can be accepted again.

The following applies:

$$T_{\text{Standby Set Heating}} \leq T_{\text{Comfort Set Heating}} \leq T_{\text{Comfort Set Cooling}} \leq T_{\text{Standby Set Cooling}}$$

or

$$T_{\text{Night Set Heating}} \leq T_{\text{Comfort Set Heating}} \leq T_{\text{Comfort Set Cooling}} \leq T_{\text{Night Set Cooling}}$$

In case of a two-stage control the setpoints of the additional stage are always derived from the setpoints of the basic stage. The temperature setpoints of the additional stage are predefined by the stage offset, which is parameterized in the ETS plug-in. The stage offset cannot be adjusted when using local control.

# Push button 2, 3, 5gang with room thermostat (RTR) and display flush-mounted

## 756627xx, 756637xx, 756657xx

Basically, one has to distinguish between two cases when adjusting the basic setpoint for the temperature (e.g. by adjusting the comfort set-temperature for heating in programming mode):

- Case 1: The basic setpoint adjustment is permanently accepted,
- Case 2: The basic setpoint adjustment is only temporarily accepted (default).

It is possible to determine via the „*accept modification of the basic temperature setpoint value permanently*“ parameter in the „*room temperature regulator function /set point values*“ parameter branch whether the set basic temperature value shall be stored in memory permanently ("Yes") or *only temporarily* ("No").

### Case 1:

If the basic temperature setpoint is adjusted, it will be permanently stored in the push button's EEPROM memory. The newly adjusted value will overwrite the basic temperature originally parameterized via the ETS!

It has to be taken into account that...:

- frequent adjustments of the basic temperature (e.g. several times a day) can affect the product life of the device as the non-volatile storage is designed for less frequent write access.
- alternatively to the local adjustment of the basic setpoint, this temperature can also be predetermined through the „basic setpoint“ via the bus, if enabled in the ETS plug-in.

Thus the basic setpoint adjusted on the push button or received by the object remains in memory even after a bus voltage failure.

### Case 2:

The basic setpoint, which was set on the push button or received via the object, stays only temporarily active in the current operating mode. In case of a bus voltage failure or following a switch-over into another operating mode (e.g. comfort after standby) the basic setpoint adjusted via local control or received via the object will be discarded and replaced by the value which was originally parameterized in the ETS.

### Notes:

- Since the set-temperatures for the „standby“ and „night“ operating modes or the setpoints for the „cooling“ control option are derived from the basic set-temperature for „heating“ - in consideration of the increase, decrease or Dead band values that are parameterized in the ETS plug-in - these set-temperatures will shift linearly by the basic change of the setpoint value.  
The temperature setpoints for the standby or night mode or „cooling“ comfort mode (Dead band) will always be stored non-volatile in the EEPROM memory.
- It has to be pointed out that temperature setpoints can only be changed or stored via local control or via the „basic setpoint“ object, if it was enabled in the ETS plug-in (cf. „4.4 Temperature setpoints“)! Any value preset via local control will not be accepted into the object.



# Push button 2, 3, 5gang with room thermostat (RTR) and display flush-mounted

## 756627xx, 756637xx, 756657xx

### 1.4.2.3 "Room temperature timer" submenu

The room temperature timer can differentiate up to 28 different switching programs and allows to switch-over the room temperature regulator's operating mode depending on the time and day of week. In programming mode it is possible to adjust, create or delete the different switching times. In addition, the timer can be activated or deactivated.

The room temperature timer must always be enabled in the ETS plug-in and full control must be accessible via the display keys until a local control of the timer is possible in the programming menu.

Programming the switching times:

The „programming the room temperature timer“ submenu is opened from the main menu via the „Enter“ command.

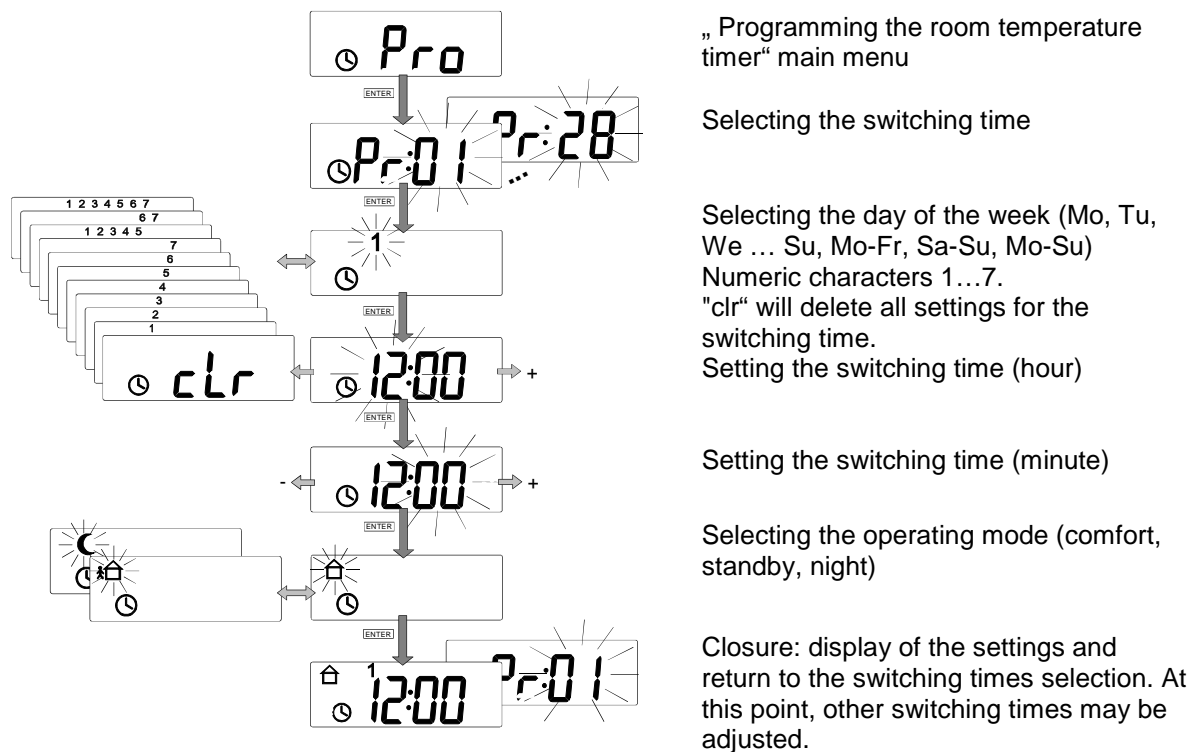

First, the switching time to be edited has to be selected using the display keys. Switching times blink, their display alternating between their number and the programmed time. If there are free memory locations, a blank display „ - - : - - „ instead of the time will appear. The selected switching time can be edited by „Enter“.

In the following submenus, the day of week, the switching time (hour, minute) and the operating mode is to be selected. The desired settings are to be made. The setting is done via the left or right display key; confirmation by „Enter“.

The Escape command will discard any changes.

The submenu for the room temperature timer will not be visible, if the timer is activated via the programming menu or via a correspondingly projected function key.

# Push button 2, 3, 5gang with room thermostat (RTR) and display flush-mounted

## 756627xx, 756637xx, 756657xx

Activating or deactivating the room temperature timer:

The room temperature timer can be activated or deactivated in the programming menu of the push button with RTR and display without affecting the stored switching times. Only if the timer is activated, the programmed switching times will be processed chronologically. And, where applicable, the operating mode of the room temperature regulator will be affected. If the timer is activated the „⌚“ symbol becomes visible in the display.

The „switching on/off the room temperature timer“ menu item is part of the main menu. The current state will be shown on the display when the menu item has been selected. The „Enter“ command will accept the new setting.

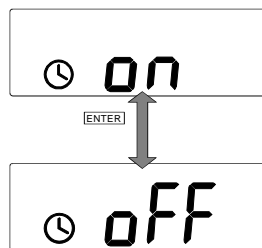

"Switching on/off the room temperature timer „ main menu

switched on: all programmed switching times will be executed.

switched off: all programmed switching times will not be executed.

The submenu for programming the switching times of the room temperature timer will not be visible if the timer is activated via the programming menu or via a correspondingly projected function key.

Following a programming operation by the ETS, the room temperature timer, which was activated via the menu, is always deactivated. The timer will be activated following the return of bus voltage, if the timer had been activated before the bus voltage failure.

#### 1.4.2.4 Activating and deactivating the key lock

The push button with RTR and display offers a feature to completely lock the rockers or keys assigned in order to, for example, protect it from children. The rockers or keys will not respond while the lock is activated. The display keys next to the display, however, can still be operated.

The lock can be activated or deactivated in the programming menu. The „activating and deactivating the key lock“ menu item is part of the main menu. The current status will be shown on the display if the menu item has been selected. The „Enter“ command will accept the new setting.

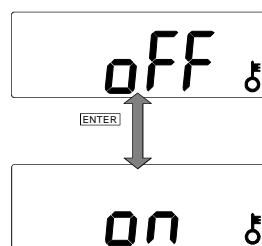

"Activating and deactivating the key lock“ main menu

switched on: all programmed switching times will be executed.

switched off: all programmed switching times will not be executed.

A key lock initiated via the programming menu is independent of a push button disable function that was activated via the bus. If a key lock has been activated in programming mode, the „Ⓚ“ symbol will not light up during normal operation.

The disable function activated via the menu is always deactivated following an ETS programming operation. The disable function will be activated following the return of bus voltage, if the timer had been activated before the bus voltage failure.

#### 1.4.2.5 Setting the display contrast

The contrast of the display can be adjusted to different lighting conditions. The „setting the display contrast“ menu item is part of the main menu. The current state will be displayed if the menu item has been selected. The „Enter“ command will accept the new setting.

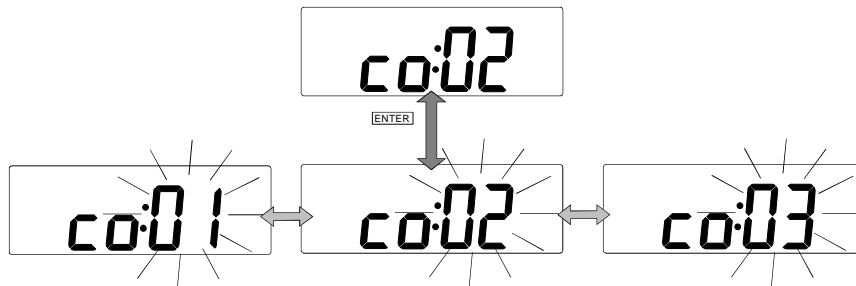

The contrast value can be adjusted in negative or positive direction (min. „co:00“ / max. „co:10“) by pressing the left or right display key.

The setting will be instantly accepted. The „Enter“ or „Escape“ command causes a return to the main menu.

The contrast value is stored in non-volatile memory so that it will remain unchanged after the return of bus voltage. Following a programming operation the display contrast is set to the default value „02“.

**Push button 2, 3, 5gang with room thermostat (RTR) and display flush-mounted  
756627xx, 756637xx, 756657xx**

**Technical  
Documentation**



1.4.2.6 Overall overview of the programming menu

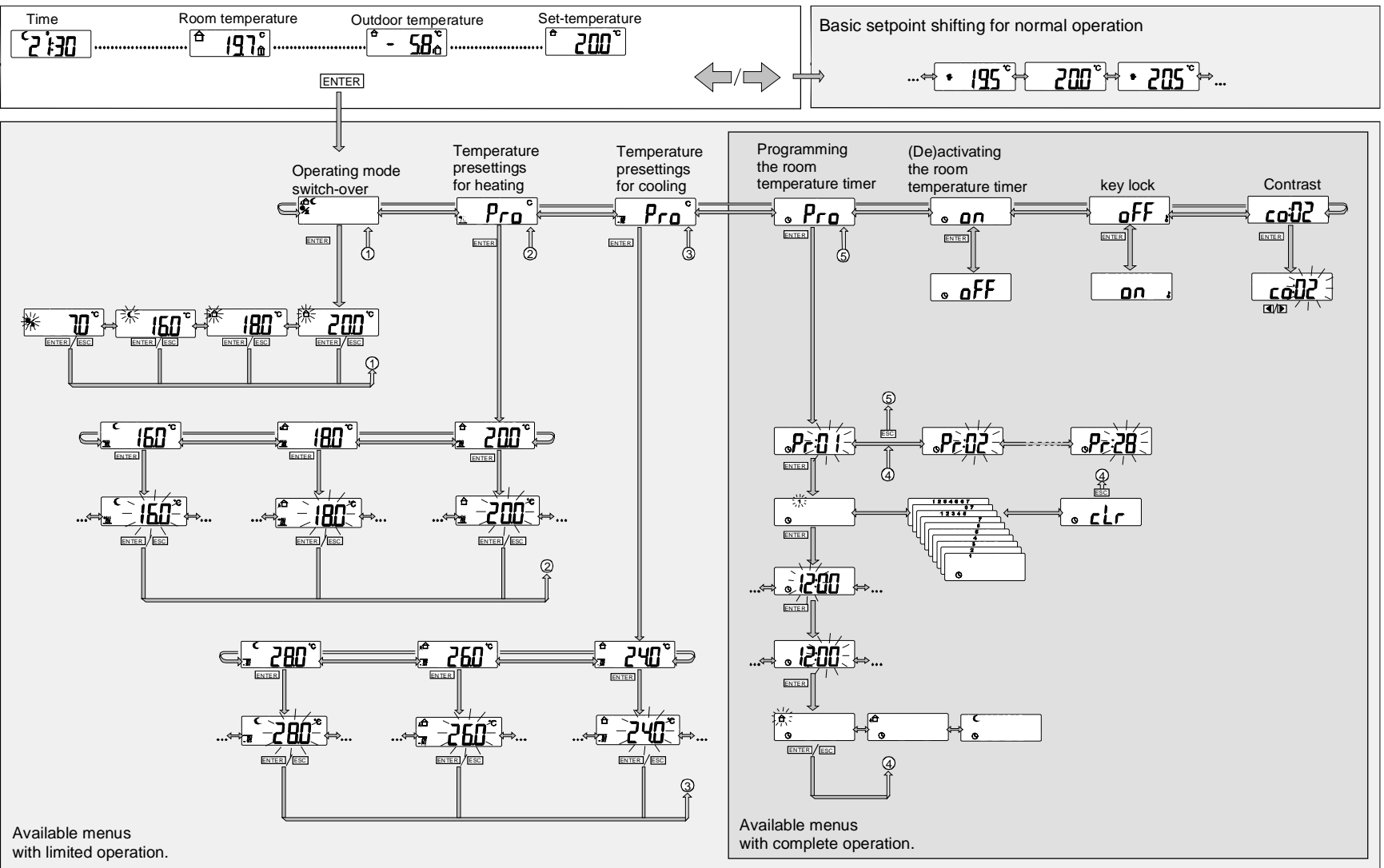

## 2. Display

### 2.1 Basic function

The display (LCD) is located between the two display keys behind the transparent rocker cover. Several functions of the integrated room temperature regulator or push button can be displayed.

The display is reflective making it easy to read in daylight conditions even from different viewing angles.

The display can show temperature values, e.g. the current room temperature, the current outside temperature, the current set-temperature or the time of day. The setting of the „display of“ parameter in the „display“ parameter branch in the ETS plug-in determines which information is to be displayed.

It is also possible to show more than one information (parameter setting e.g. „time /outside/ setpoint temperature“). If more than one information is selected, the display will alternate between them. The display duration of one information can be adjusted with the „switch-over time“ parameter

#### Display of temperature values:

The room temperature measured by the push button and/or the outside temperature received via the bus and/or the current set-temperature of the first control circuit can be displayed.

The display of the room temperature has a resolution of 0.1 °C and ranges from – 99.9 °C to + 99.9 °C . The display is automatically updated as soon as the measured temperature change exceeds the resolution interval.

The display of the outside temperature has a resolution of 0.1 °C and ranges from – 99.9 °C to + 99.9 °C. The display is automatically updated as soon as a temperature value telegram is received via the „outside temperature sensor“ object. The outside temperature is, if parameterized, only shown on the display and will not be used for further temperature or actuating variable calculations.

The set-temperature display has a resolution of 0.5 °C as the setpoint is always rounded mathematically to half °C by the controller. The possible range of temperatures depends on the parameterized control option and is limited by the values for the frost and/or heat protection temperature. The display is automatically updated as soon as there is a new set-temperature for the controller (e.g. a change of the operating mode or the basic setpoint, etc.). If there are two control circuits with separate setpoints, only the setpoint of the first circuit is shown.

#### Display of time of day:

If desired, the time of day can be shown on the display. The time of day received, for example, by a KNX/EIB clock timer via the „time signal“ object 54 will be displayed and the system clock implemented in the device will be initialized.

Once initialized this clock will internally continue to run and update the display every minute. The „:“ symbol between the hour and minute display blinks every second.

The information on the day of week is attained from the received time signal and used to control the room temperature timer. In normal operation, the weekdays displayed on the push button are numerical characters.

The time of day is displayed in the 24h system.

The time signal should be transmitted at least on an hourly basis in order to minimize the deviation of the internal clock. As long as there has been no time signal received via the objects, the display will show „--:--“. The display will also appear, if the internal clock has not been updated at least once a day via the bus (update check at 4:00 at night). In this case, the clock will, however, continue to run with the expected deviation. If applicable, parameterized switching times of the room temperature timer will still be processed!













Moreover, the internal time gets lost in case of a bus voltage failure so that following the return of bus voltage the time signal should be transmitted by a clock timer.

**Push button 2, 3, 5gang with room thermostat (RTR) and display flush-mounted**  
**756627xx, 756637xx, 756657xx**

2.2 Symbols

Depending on the operating mode of the device, the following symbols can be displayed in addition to the temperature or the time of day:



Symbol	Meaning
	Operating mode „comfort“ is active or operating mode „comfort“ is preselected in the programming menu or the comfort set-temperature is displayed.
	“Standby“ operating mode is active or preselected in the programming menu or the standby set-temperature is displayed.
	“Night“ operating mode is active preselected in the programming menu or the night set-temperature is displayed.
	“Frost/heat protection“ operating mode is active preselected in the programming menu.
	The controller disable (dew point mode) is activated.
	A basic setpoint shifting is active. In this case the setpoint was shifted via one of the display or function keys or via a controller extension.
	A push button disable function has been activated via the bus. This symbol appears only if the control is disabled.
	The room temperature timer is activated. The switching programs are being processed.
	The room is heated or a set-temperature for heating is depicted in programming mode.
	The room is cooled or a set-temperature for cooling is depicted in programming mode.
	The current room temperature is displayed.
	The current outside temperature is displayed.
1...7	Display of the weekdays (Monday (1) to Sunday (7))
	Reserved for future functions.

# Push button 2, 3, 5gang with room thermostat (RTR) and display flush-mounted

## 756627xx, 756637xx, 756657xx

### 2.3 Display data during a programming operation, initialisation or failure

The status information is shown on the display during an ETS programming operation of the device.

If the ETS has established a programming connection to the device via the bus, the „Pd „ (Pd = Parameter Download) message will appear on the display. In that state the device is programmed with the project data. All push button and room temperature regulator functions are deactivated.

It is possible to start a complete programme download while, for example, downloading an update of the firmware or during failure (previously interrupted programming operation). For this purpose, the „*With next download: transmit all*“ item is to be selected in the ETS plug-in in „*Setting – Options – Hardware*“ followed by an application download. During the programming the „Fd „ message is shown on the display (Fd = Firmware Download).

Caution: Downloading the firmware can take several minutes! A programming operation may not be interrupted! The push button's keys do not respond during the download.

After successfully completing a programming operation or after plugging a programmed push button on the bus coupler with connected bus voltage, the push button model and the installed software version is seen on the display for a short period of time.

The „5F:1.3 „ display, for example, indicates a 5 gang push button with RTR and display with an installed firmware version 1.3.

Afterwards the device is automatically initialized. In this state the „In „ message is displayed (In = Initializing) The device (push button also as a room temperature regulator) is ready for use.

Because the bus coupler and the push button with RTR and display make up one unit and because they cannot be arbitrarily be exchanged, the push button will check whether the parameter information in the bus coupler corresponds to those in the memory of the push button after the return of bus voltage or when the push button is plugged on the bus coupler.

In case the parameterizations do not match because the unit was not started up together or because the push button or bus coupler was exchanged, the push button with RTR and display will show „nP „ on the display to signal that it does not have any valid parameters (nP = no Parameter). In this case the push button does not respond to any key-press. A new programming or re-exchange is required.

„Er r „, plus a numeric character showing on the display indicates that the push button with RTR and display is not functional. In this case the push button does not respond and has to be exchanged.

If the display shows the push button identifier and the „BL“ (BL = Bootloader) qualification (e.g. „5F:BL „), the push button is plugged onto an unemployable flush-mounted bus coupler. In this case the bus coupler is to be exchanged for a new dedicated UP-BCU 1.

If the push button displays only the push button identifier without the firmware version (e.g. „5F:- - „), the device has no valid or executable firmware installed. This may happen, for example, if a previous firmware download was faulty or interrupted for some other reasons. In this case the push button with RTR and display does not respond any further.

It is recommended to start a new firmware download (cf. „[Software information – Firmware](#)“ at the end of [this document](#)).



### 3. Push button functions:

#### 3.1 Rocker layout

Depending on the projected model the push button with RTR and display features up to 5 rockers or 10 keys (function keys), which can be assigned parameterizable functions in the ETS plug-in. The display keys next to the display cannot be parameterized. Predetermined functions are assigned to them.

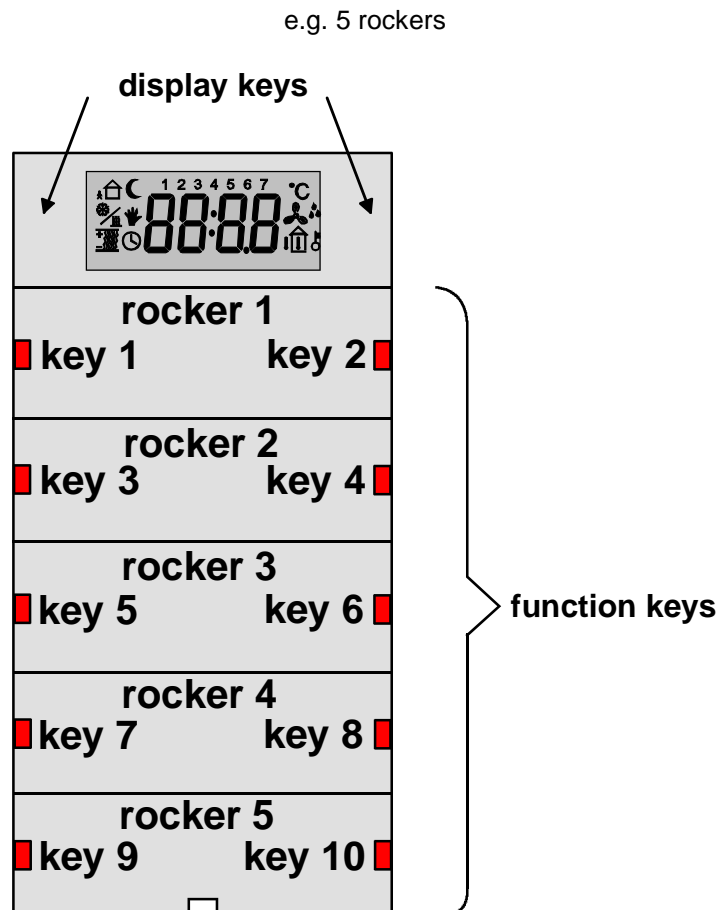

Depending on the application included in the ETS project (2 gang, 3 gang or 5 gang) the required number of rockers and LED's is automatically applied in the ETS plug-in.

In order to configure the projection of the push button functions more clearly, a preview window is optionally available in the ETS plug-in. This window can be activated in the „*configuration*“ menu in „*preview*.“ If the window is enabled, it is possible to jump directly into the corresponding parameter branch via mouse-click on one of the rockers or keys and thus to parameterize the selected rocker or key.

It is possible to assign an identifier to a rocker or key in the corresponding parameter branch. This identifier simply serves as a better orientation in the plug-in and is neither displayed in the preview window nor is it downloaded into the device.

### 3.2 Operation-LED

Each push button with RTR and display model features a white operation-LED that is located in the centre at the lower margin of the lower rocker.

The function of the operation-LED can be preset via the „*operation-LED*“ parameter in the „display“ parameter branch. The LED can be permanently switched on (setting: „ON“), automatically switched off (setting: „automatic switch-off“) or it can be switched via a separate object (setting: „*switching via object*“).

If set to automatic switch-off, the operation-LED will be switched on by pressing any key and will automatically switch off after a time period adjusted via the „*automatic switch-off operation-LED*“ parameter. Switching times ranging from approx. 1 sec to approx. 20 minutes can be adjusted.

Alternatively, the operation-LED can be switched via the „*switching operation-LED*“ object 22. The polarity of the object is predetermined. If an object value = „1“ the LED will be switched on while switched off, if an object value = „0“.

Following the return of bus voltage the object value of the „*switching operating LED*“ object is always „0“.

In addition, the „*kind of switching*“ parameter defines whether the operation-LED is permanently switched on for an object value = „1“ (setting: „ON“) or whether it is switched off again after a parameterizable time (setting: „*Automatic switch-off*“). In the latter case the operation-LED will be switched on only if receiving another „1“ telegram via the object 22. A „0“ telegram will immediately switch off the LED.

# Push button 2, 3, 5gang with room thermostat (RTR) and display flush-mounted 756627xx, 756637xx, 756657xx

## 3.3 Rocker functions

The push button, room temperature regulator, controller extension and scene functions have to be considered separately.

Independent of each other and depending on the projected model, there are up to 5 rockers that can be allocated with different functions.

The two display keys next to the display are always reserved for the local control (programming mode and basic setpoint shifting). More details on the exact function of this rocker is found in the description of the control level switch-over (cf. „1.4 Programming mode/ local control“). The display keys feature no status-LED.

The rockers can be – parameterizable in the ETS plug-in – assigned the following push button functions. One distinguishes between rocker and key actuation.

Function	Rocker actuation	Key actuation
No function	✓	✓
Switching / pushing	---	✓
Switching	✓	---
Dimming	✓	✓
Shutter	✓	✓
Light-scene extension / recall	---	✓
Value transmitter 1-byte	---	✓
Value transmitter 2-byte	---	✓
Two telegrams	✓	✓
Operating mode switch-over *	✓	✓
Setpoint shifting *	---	✓
Room temperature timer control	---	✓
Controller extension **	✓	✓

\*: The „operating mode switch-over“ and „setpoint shifting“ functions actuate the internal room temperature regulator. The exact function of a rocker parameterized to these functions is found in the description of the room temperature regulator functions ([chapter 4](#)).

\*\* : The „controller extension“ function is parameterizable with enabled controller extension functions. The exact function of a rocker parameterized to these functions is found in the description of the controller extension functions ([chapter 5](#)).

The push button function can principally be enabled. For this purpose the „push button function“ parameter in the „push button RTR“ parameter branch is to be set to „Enabled“ in the ETS. In case the push button function is „Disabled“, the selection of the push button functions will be adjusted so that in this case only the functions of the enabled function elements are parameterizable („room temperature regulator operation“, „room temperature timer operation“, „controller extension“ and/or „light-scene extension recall“).

The rockers actuation type is predefined via the „actuation“ parameter in the „push button function“ parameter branch. A rocker actuation or a key actuation can be parameterized separately for each rocker. The left and the right key of a rocker make one pair of key; combined they are assigned one function. When pressing the keys, the left and the right key of a rocker have to be considered separately so that two functions can be executed.

Depending on how the actuation is parameterized, the status-LED's make up one pair as well or they can be contr. separately. How exactly the control of the status-LED's takes place can be param. in both cases.

The push button functions illustrated in the table can be parameterized independently of each other for the different rockers or keys. That will dynamically change the parameter branch in the ETS plug-in and thus change the object table as well.

The function to be executed by a key-press is predetermined by the „rocker function“ or the „key function“ parameter in the „push button function / general / [key designation]“ parameter branch.

### 3.3.1 Rocker actuation

#### 3.3.1.1 "No function" function

If the rocker's „*rocker function*“ parameter is parameterized to „*no function*“, the affected actuation keys and thus the associated objects are deactivated. Only the status-LED's can be controlled via the status object. The control is predefined by the „*function of the left/right status-LED*“ parameter in the „*push button function / general / [key designation] / status of rocker X*“ parameter branch.

#### 3.3.1.2 "Switching" function

If the rocker's function is parameterized to „*switching*“ the „*command on pressing a rocker*“ parameter and the „*switching*“ object will become visible. The „*command on pressing a rocker*“ parameter determines the switching commands which are to be output on the bus when pressing the left and the right key. Executable switching commands may include „*ON*“, „*OFF*“ or „*TOGGLE*“. The value, which is stored in the switching object, is switched and transmitted when executing the „*TOGGLE*“ command. The commands are to be preset and preselected in combination only for the left and right key. In addition, the transmission of a switching command may be suppressed with one key-press (setting „*---*“).

The two status-LED's of the rocker (left and right) can be parameterized and controlled irrespective of the rocker function. The „*function of left / right status-LED*“ parameter in the „*push button function / general / [key designation] / status of rocker X*“ parameter branch determines whether the LED is permanently switched on or off or whether it is controlled via the „*rocker X [status left / right]*“ object. In the latter case the polarity of the status objects is definable.

#### 3.3.1.3 "Dimming" function

If the function of the rocker is parameterized to „*dimming*“, several parameters for the dimming function as well as the „*switching*“ and „*dimming*“ objects will become visible. The „*command on pressing a rocker*“ parameter determines the switching or dimming commands, which are to be output on the bus when pressing the left and the right key. Executable switching commands may include „*darker (OFF)*“, „*Brighter (ON)*“ or „*TOGGLE*“.

With the „*darker (OFF)*“ command a short-time key-press will trigger an OFF telegram; a long key-press will trigger a dimming telegram (darker). With the „*brighter (ON)*“ command a short key-press will trigger an ON telegram; a long key-press will trigger a dimming telegram (brighter). With the „*TOGGLE*“ command a short key-press will switch-over the switching state which is internally saved in the switching object. If the saved state is ON (OFF), an OFF (ON) telegram will be triggered. A long key-press will transmit a „*brighter*“ telegram followed by a „*darker*“ telegram and vice versa.

The commands are to be preset and preselected in combination only for the left and right key.

In addition, the dimming increments can be adjusted for „*increasing and decreasing brightness*“ and the „*time between switching and dimming*“. A „*stop telegram*“ can be enabled at the end of the dimming operation (telegram transmission on releasing the push button). If the „*telegram repetition*“ parameter is set to „*YES*“, dimming telegrams can be periodically transmitted during a key-press. The „*time between two dimming telegrams*“ can be adjusted. In each case this time has elapsed, a new dimming telegram will be issued with the parameterized dimming increment.

The two status-LED's of the rocker (left and right) can be parameterized and controlled irrespective of the rocker function. The „*function of left / right status-LED*“ parameter in the „*push button function / general / [key designation] / status of rocker X*“ parameter branch determines whether the LED is permanently switched on or off or whether it is controlled via the „*rocker X [status left / right]*“ object. In the latter case the polarity of the status objects is definable.

3.3.1.4 "Shutter" function

If the rocker function is parameterized to „shutter“, several parameters for the shutter function as well as the „STEP operation“ and „MOVE operation“ objects will be visible. The „operation concept“ parameter predefines the telegram sequence for short and long-time telegrams that are transmitted with or during key actuation.

- „Step - move - step“:

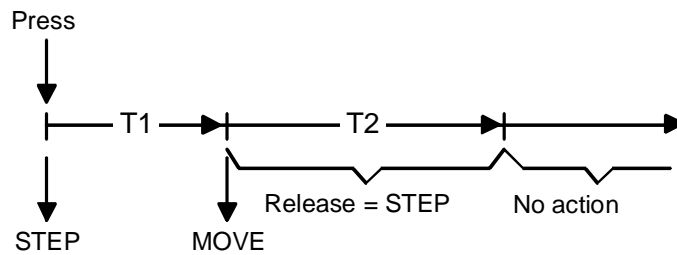

Pressing a rocker's key will transmit a step command and time T1 is started ("time between step and move operation") No other telegram is transmitted, if the key is released within T1. This step serves to stop a continuous run in progress.

If the key is pressed for more than T1, a MOVE command is automatically transmitted after T1 has elapsed and time T2 is started ("Lamella adjustment time") If the key is released again within T2, the push button will transmit a step-telegram. This function is used to adjust the Lamellas. T2 should correspond to the time required for a 180° rotation.

- „Move - step“:

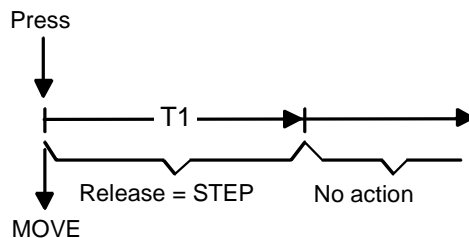

Pressing a rocker's key will transmit a Move command and time T1 is started ("Lamella adjustment time") If the key is released again within T1, the push button will transmit a step-telegram. This function is used to adjust the Lamellas. T1 should correspond to the time required for a 180° rotation.

The „command on pressing the rocker“ parameter determines the polarity of the telegrams for long or short-time operation, i.e. their activated direction depending on the actuated (left or right) key. Executable commands may include „UP“, „DOWN“ or „TOGGLE“. The commands are to be preset and preselected in combination only for the left and right key.

The two status-LED's of the rocker (left and right) can be parameterized and controlled irrespectively of the rocker function. The „function of left / right status-LED“ parameter in the „push button function / general / [key designation] / status of rocker X“ parameter branch determines whether the LED is permanently switched on or off or whether it is controlled via the „rocker X [status left / right]“ object. In the latter case the polarity of the status objects is definable.

3.3.1.5 "Two telegrams" function

With only one key-press this function allows to transmit two different telegrams on the bus via different communication objects. Optionally, a 1-bit or 1-byte data type can be set for each of the two objects. Thus several lighting groups, for example, can be switched on or off or adjusted to a brightness value without having to use scenes.

The switching commands (ON, OFF, TOGGLE, no function) or value commands (0...255) can be parameterized differently for each rocker's key.

The first telegram is transmitted as soon as a rocker's key is pressed. The presetting will cause the transmission of the second telegram after a delay time, which is started with the key-press. Thus the key does not have to be pressed down for the transmission of the second telegram. The delay time is activated via the „*delay between the 1<sup>st</sup> and 2<sup>nd</sup> telegram*“ parameter ("Yes") and defined via the „*time between the 1<sup>st</sup> and 2<sup>nd</sup> telegram*“ parameter. Delay times can be parameterized between one second and 30 minutes.

The delay time can be post-triggered by successive key actuations.

Alternatively, the delay time can be deactivated so that the two telegrams can be successively transmitted on the bus without delay when pressing a key. In this case the chronological sequence does not have to be predetermined.

Releasing the key has no effect.

Example:

Type of the 1<sup>st</sup> object = switching (TOGGLE)

Type of 2<sup>nd</sup> object = value (255)

Delay = 2 sec

Only the rocker's left key is actuated.

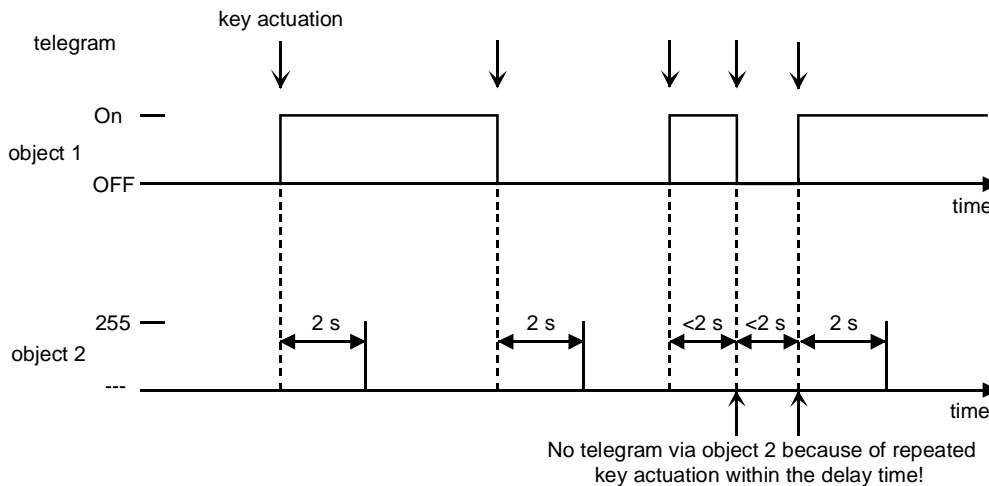

The two status-LED's of the rocker (left and right) can be parameterized and controlled irrespectively of the rocker function. The „*function of left / right status-LED*“ parameter in the „*push button function / general / [key designation] / status of rocker X*“ parameter branch determines whether the LED is permanently switched on or off or whether it is controlled via the „*rocker X [status left / right]*“ object. In the latter case the polarity of the status objects is definable.



### 3.3.2 Key actuation

#### 3.3.2.1 "No function" function

The key is deactivated, if the „*key function*“ parameter is set to „*no function*“. Only the status-LED can be used. The control is defined by the „*function of the status-LED*“ parameter in the „*push button function / general / [key designation]*“ parameter branch. It is possible to permanently switch on or off the LED or to switch the LED via a separate communication object. In the latter case the polarity of the status objects in the „*push button function / general / [key designation] / state of push button*“ parameter branch is parameterizable.

#### 3.3.2.2 "Switching / pushing" function

If the key's function is parameterized to „*switching / pushing*“, the „*command on pressing the push button*“ and „*command on releasing the push button*“ parameters and the „*switching*“ object will be visible.

The „*command on pressing a rocker / releasing the key*“ parameters determine the switching commands which are to be output on the bus by releasing the key. With these two parameters, which are independent of each other, it is also possible to execute a momentary contact function (e.g. pressing = on, releasing = off).

Executable switching commands may include „ON“, „OFF“ or „TOGGLE“. „*TOGGLE*“ will switch and transmit the value, which is stored in the switching object. In addition, the transmission of a switching command can be suppressed with one key-press (setting „no function“).

The status-LED function is defined by the „*function of the status-LED*“ parameter in the „*push button function / general / [key designation]*“, parameter branch. It is possible to permanently switch on or off the LED, to signal a key actuation, to indicate the status of the switching object or to switch the LED via a separate communication object. In the latter case the polarity of the status objects in the „*push button function / general / [key designation] / state of push button*“ parameter branch is parameterizable.

#### 3.3.2.3 "Dimming" function

If the function of the key is parameterized to „*dimming*“ (one-touch dimming), several parameters for the dimming function as well as the „*switching*“ and „*dimming*“ objects will be visible. The „*command on pressing the push button, push button function*“ parameter determines the switching or dimming commands, which shall be output on the bus when pressing a key. Executable commands may include „*darker (OFF)*“, „*brighter (OFF)*“ or „*brighter / darker (TOGGLE)*“.

With the „*darker (OFF)*“ command a short key-press will trigger an OFF telegram; a long key-press will trigger a dimming telegram (darker). With the „*brighter (ON)*“ command a short key-press will trigger an ON telegram; a long key-press will trigger a dimming telegram (brighter). With a „*brighter / darker (TOGGLE)*“ command a short key-press will switch-over the switching state that is internally stored in the switching object. If the saved state is ON (OFF), an OFF- (ON) telegram will be triggered. A long key-press will transmit a „*darker*“ telegram followed by a „*brighter*“ telegram and vice versa.

In addition, the dimming increments can be adjusted for „*increasing and decreasing brightness*“ and the „*time between switching and dimming*“. A „*stop telegram*“ can also be released at the end of the dimming operation (telegram transmission on releasing the push button). If the „*telegram repetition*“ parameter is set to „YES“, dimming telegrams can be periodically transmitted during a key-press. The „*time between two dimming telegrams*“ is adjustable. In each case this time has elapsed, a new dimming telegram is issued with the parameterized dimming increment.

The status-LED function is defined by the „*function of the status-LED*“ parameter in the „*push button function / general / [key designation]*“, parameter branch. It is possible to permanently switch on or off the LED, to signal a key actuation, to indicate the status of the switching object or to switch the LED via a separate communication object. In the latter case the polarity of the status objects in the „*push button function / general / [key designation] / state of push button*“ parameter branch is parameterizable.

3.3.2.4 "Shutter" function

Different parameters for the shutter function and the „STEP operation“ und „MOVE operation“ objects will be visible when parameterizing the „shutter“ function. The „operation concept“ parameter (telegram sequence) predefines the telegram sequence for short and long telegrams that are transmitted when actuating a key.

- „Step - move - step“:

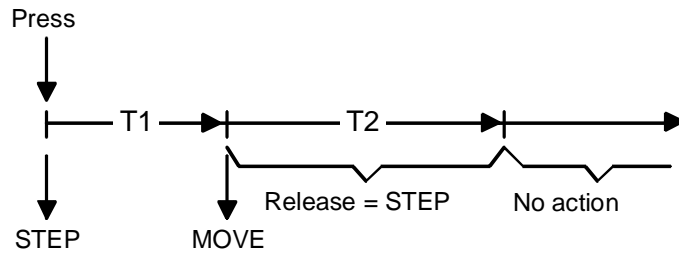

Pressing a key will transmit a step command and time T1 is started ("time between step and move operation") No other telegram will be transmitted, if the key is released within T1. This step serves to stop a continuous run in progress.

If the key is pressed for more than T1, a MOVE command is automatically transmitted after T1 has elapsed while time T2 ("Lamella adjustment time") is started. If the key is released again within T2, the push button will transmit a step-telegram. This function is used to adjust the Lamellas. T2 should correspond to the time required for a 180° rotation .

- „Move - step“:

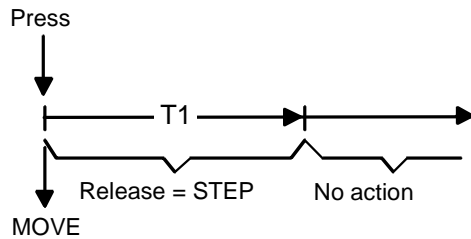

Pressing a key will transmit a Move command and time T1 is started ("Lamella adjustment time"). If the key is released again within T1, the push button will transmit a step-telegram. This function is used to adjust the Lamellas. T1 should correspond to the time required for a 180° rotation.

The „function of shutter push button“ parameter determines the polarity of the telegrams for long or short-time operation, i.e. their direction when the key is actuated. Executable commands may include „UP“, „DOWN“ or „TOGGLE“.

The status-LED function is defined by the „function of the status-LED“ parameter in the „push button function / general / [key designation]“, parameter branch. It is possible to permanently switch on or off the LED, to signal a key actuation or to switch the LED via a separate communication object. In the latter case the polarity of the status object in the „push button function / general / [key designation] /state of push button“ parameter branch is parameterizable.



### 3.3.2.5 "Value transmitter 1-byte" and „value transmitter 2-byte“ function

When parameterized as a 1-byte value transmitter (e.g. for dimming value transmitter applications), the push button will transmit an 8-bit value on the bus when pressing a key-press. The value to be transmitted is parameterized in the ETS plug-in and can lie within the value range of 0 to 255.

When parameterized as a 2-byte value transmitter, 2-byte values can be transmitted on the bus. The „function as“ parameter determines whether the value is a temperature value, a brightness value or a dimensionless 2-byte reading.

The range of values of the parameterizable temperature value lies between 0 °C and 40 °C in 1 °C increments. The brightness value may lie between 0 lux and 1500 lux in 50 lux increments. In case that brightness values are parameterized which do not correspond to the 50-lux increments, the plug-in will automatically adjust the value by rounding it up or down. The range of values possible for the 2-byte value transmitter lies between 0 and 65535.

#### Value readjustment:

When parameterizing a value transmitter is parameterized it is possible to readjust the value to be transmitted via a long key-press (> 5 sec). This will lower the predefined value by the parameterized increment before transmitting it. The previously transmitted value is stored after releasing the key. The next long key-press will change the direction of the value readjustment.

The adjustment increments for the 1-byte or 2-byte value transmitter are parameterizable. The increments for the temperature value transmitter are set to 1 °C while the increments for the brightness value transmitter are set to 50 lux.

The status-LED function is defined by the „function of the status-LED“ parameter in the „push button function / general / [key designation]“, parameter branch. It is possible to permanently switch on or off the LED, to signal a key actuation or to switch the LED via a separate communication object. In the latter case the polarity of the status object in the „push button function / general / [key designation] /state of push button“ parameter branch is parameterizable.

The status-LED of the actuated key and the one of the opposite key will blink during a value readjustment with approx. 3 Hz no matter what functions the LED is parameterized for (cf. example on the next page). No other key may be actuated during a value readjustment!

**Push button 2, 3, 5gang with room thermostat (RTR) and display flush-mounted**  
**756627xx, 756637xx, 756657xx**

The following demonstrates a value readjustment considering as example a 1-byte value transmitter:

1.Function of the status-LED *always ON*  
*Value (0...255)* 17  
*Increments (1...10)* 5

⇒ The status-LED is always on. The status-LED will blink during the value readjustment.

2.Function of the status-LED *Actuation indicator*  
*Light-emitting period of actuation indicator* 3 sec  
*Value (0...255)* 17  
*Increments (1...10)* 5

⇒ The status-LED lights up for the duration of the parameterized time when pressing a key. The status-LED will blink during the value readjustment.

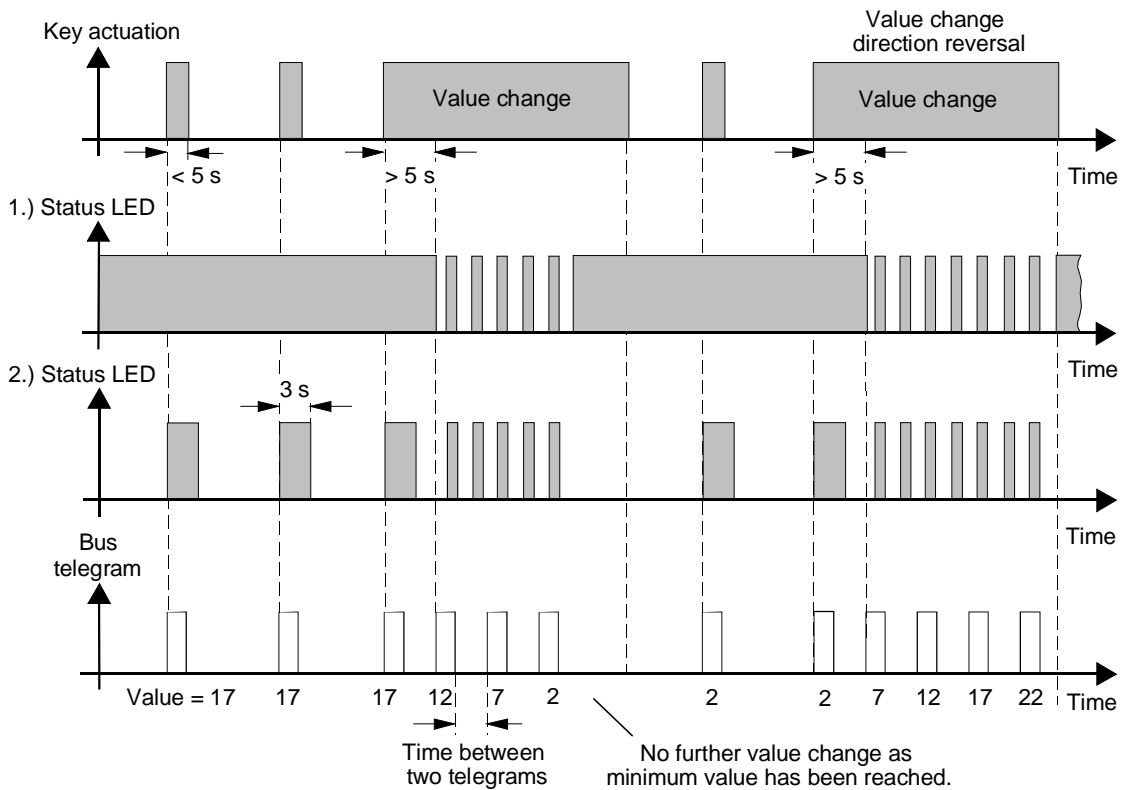

Notes:

- Depending on the parameterized increments it might be possible that the value „0“ never reaches „0“. This will ensure that the value, which was originally parameterized by the ETS, can be reset with a new value readjustment.
- The newly adjusted values are only stored in RAM. Thus, following a bus voltage failure or a plugging/unplugging of the user module, these values will be replaced by the preset values, which were originally programmed via the ETS.

### 3.3.2.6 "Light-scene extension/recall" function

This function determines whether an 'external' light-scene is to be addressed via the light-scene extension object or via one of the push button's internal scenes. The „*function as*“ parameter determines the mode of action.

If the key function is parameterized to „*light-scene extension*“, the „*light-scene extension*“ will be enabled. Light-scenes, which are stored in another bus device that features a light-scene function, may be recalled via this object via a short key-press (< 1 sec). The light-scene number parameterized in the ETS plug-in will be transmitted (1 to 64).

If the function is parameterized to „*internal scene request*“, a short key-press (< 1 sec) will recall the scene stored in the push button RTR. In doing so, the corresponding scene number (1 to 8) must be predetermined in the ETS plug-in. An extension object is not required for this function. In addition, an internal scene can only be recalled with enabled scene function!

The status-LED of the actuated key lights up for the duration of the parameterized time.

The „*memory function* „ parameter can be used to determine whether the 'external' light-scenes or the 'internal' scenes are only to be recalled or also to be stored following a long key-press (> 5 sec).

It is possible to create a memory telegram depending on the parameterized light-scene number with a parameterization as „*light-scene extension*“ with memory function. A long key-press > 5 sec will transmit the corresponding memory telegram.

A parameterization as „*internal scene request*“ with memory function allows to store an internal scene acc. to the parameterized scene number via a long key-press > 5 sec. The scene control of the push button with RTR and display requests the current values of the scene objects from the actuators via the bus and stores them in non-volatile memory.

Attention should be paid to the fact that these read flags ("R" flags) are set with the corresponding actuator objects!

The status-LED function is defined by the „*function of the status-LED*“ parameter in the „*push button function / general / [key designation]* „ parameter branch. It is possible to permanently switch on or off the LED, to signal a key actuation or to switch the LED via a separate communication object. In the latter case the polarity of the status object in the „*push button function / general / [key designation] /state of push button*“ parameter branch is parameterizable.

While information is actively stored the status-LED of the actuated key and the one of the opposite key will blink (approx. 3 Hz). No other key may be pressed during this time!

A short key-press < 1 sec will simply recall the parameterized light-scene. If the key is pressed for more than 1 sec but no longer than 5 sec, neither a recall nor a saving procedure will be triggered.

The status-LED of the actuated key lights up for the duration of the parameterized time.

Examples for the memory function:

1. Function of the status-LED

*Always ON*

⇒ The status-LED is always on. During saving it will blink for approx. 3 sec.

2. Function of the status-LED

*Actuation indicator*

*Light-emitting period of actuation indicator 1 sec*

⇒ The status-LED lights up for the duration of the parameterized time when pressing a key. During saving it will blink for approx. 3 sec.

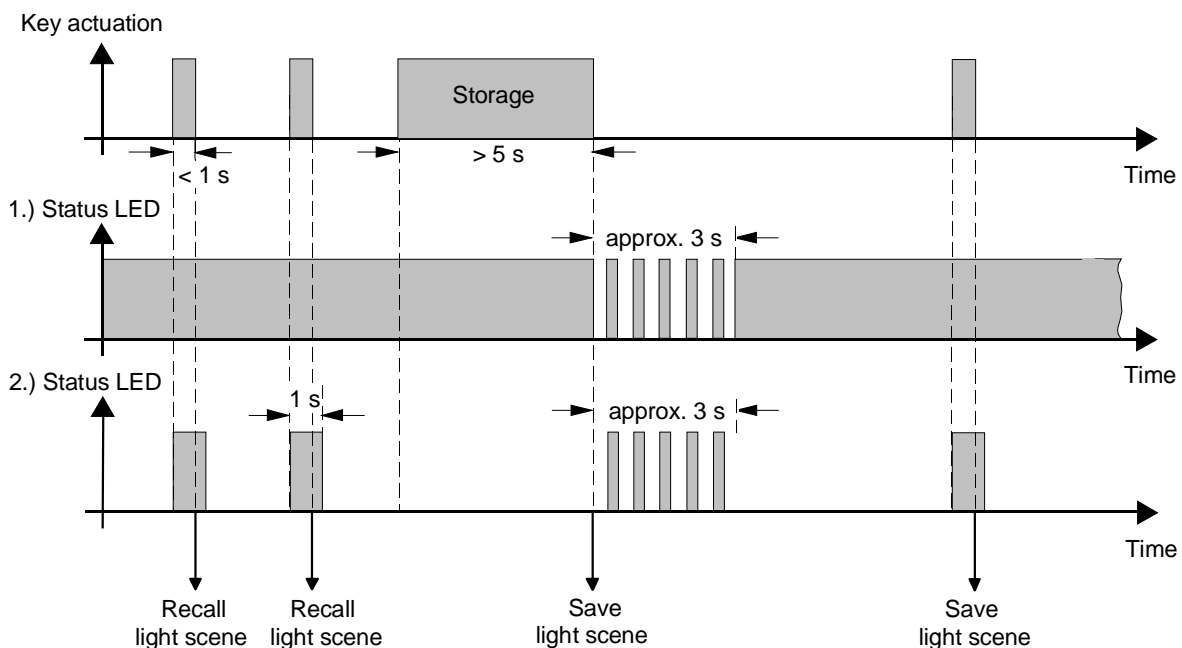

3.3.2.7 "Room temperature timer operation" function

As soon as the room temperature timer is enabled in the ETS plug-in, the control function of the room temperature timer can additionally be set.

With room temperature timer control it is possible to activate or deactivate the room temperature timer depending on the parameterized response to a key-press. Switching (toggling between activated and deactivated) is possible.

The function of the status-LED is parameterizable. That way the „display timer active“ and „display timer inactive“ settings can be selected in addition to the „off“, „on“ and „operation indication“ standard settings. In this manner the status-LED's can signal whether the function linked with an associated key is activated or deactivated. This signaling will take place even if the corresponding function has been locally activated or deactivated in programming mode.

Alternatively, the LED can be switched via a separate communication object. The polarity of the status object in the „push button function / general / [key designation] /state of push button“ parameter branch is parameterizable.

It has to be pointed out that the control function of the room temperature timer in programming mode is principally available independent of a function parameterized for the keys.

### 3.4 Disable function with push button function

The push button features a disable function, which allows to disable individual or all rockers. It is also possible to have all rockers behave like one explicitly specified rocker.

The disable function can be enabled via the „*disabling function*“ parameter in the „*push button functions – disabling*“ parameter branch. The settings have the following meanings:

Settings:

- "Single rocker disabled" → - The rockers 1-2 (2 rocker sensor), 1-3 (3 rocker sensor) or 1-5 (5 rocker sensor) can be disabled independent of each other.  
- The display keys (room temperature regulator control / programming menu) always have a function assigned to them!
- "Push button disabled" → - The entire push button incl. the display keys is disabled. In this case, the room temperature regulator can only be controlled via the bus, if enabled.
- "Push button not disabled" → - No disable function is enabled (default). The push button runs in normal operation.
- "Functions of all rockers like..." → - All rockers behave like the parameterized rocker. In this case the function assigned to the parameterized rocker is executed every time any other rocker is actuated. The status-LED's of the rockers are controlled as in „normal operation“.  
- The display keys are not affected by this disable function and demonstrate 'normal' behaviour.

If the disable function is activated, the „“ symbol will be displayed.

Additionally, the keys of the device can be locally disabled in the programming menu, for example, as a child protection ("Settings" menu). This type of disable is independent of a disable function that has been initiated via the bus. If a key lock has been activated in programming mode, the „“ symbol will not light up. In addition, an active key lock also suppresses the key-help.

It has to be pointed out that the room temperature control can additionally be influenced by the controller disable function cf. „[4.6 Disable functions of the room temperature regulator](#)“) Thus, keys or rockers which have been assigned to a room temperature control, have to be disabled via the push button or via the controller disable function. Even if the control is disabled, the „“ symbol will light up in the display.

Following the return of bus voltage, the disable function will still be activated, if the disable function had been activated before the bus voltage failure took place. After a programming operation by the ETS, the disable function is always activated.

The polarity of the disable object is parameterizable.

If the polarity of the disable object is set to „*Inverted (disable = 0)*“, the push button will not immediately be disabled after the return of bus voltage or a download, if the disable function was not switched on before the bus voltage failure took place. In this case the disable function is only activated after an object update (value = „0“) for the disable object.

## Functional description

### 4. Room temperature regulator functions

#### 4.1 Operating modes

The room temperature regulator features several operating modes. It is possible to activate different temperature setpoints that, for example, depend on the presence of a person, the status of the heating or cooling system, the time of day or day of week.

- Comfort mode:

The comfort mode should be activated if people are present in the room that requires the room temperature to be adjusted to a comfortable and appropriate value. The switch-over into this operating mode can also take place via presence control.

An activated comfort mode is indicated on the display by the „ „ symbol.

- Standby mode

If a room is not in use during the day as people are absent, the standby mode may be activated. This will set the room temperature to a standby value thus saving heating or cooling energy in the process.

An activated standby mode is indicated on the display by the „ „ symbol.

- Night mode

During the night hours or during a longer absence it is often best to adjust the room temperature to cooler temperatures with heating systems (e.g. in bedrooms). In this case cooling systems can be adjusted to higher temperature values, if climate control is not required (e.g. in offices). For this purpose the night mode can be activated.

An activated night mode is indicated on the display by the „ „ symbol.

- Frost / heat protection mode

Frost protection is necessary, if, for example, the room temperature may not fall below critical values with the window opened. Heat protection might be necessary, if the temperature in a mostly warm environment becomes too high due to external influences.

In these cases a freezing or overheating of the room can be prevented by activating the frost/heat protection depending on the adjusted „heating“ or „cooling“ control option by specifying an individual temperature setpoint.

An activated frost/heat protection is indicated on the display by the „ „ symbol.

- Comfort mode extension (temporary comfort mode)

The comfort mode extension is to be activated from the night mode or the frost/heat protection (not triggered by the „window status“ object). It can be used to adjust the room temperature to the comfort temperature for a certain amount of time, if, for example the room 'is used' during the night as well. It is activated only via a parameterized presence key or in this case also via the presence object. The comfort mode extension is automatically deactivated after a settable time has elapsed or by pressing the presence key again or via receiving a presence object value = „0“. The extension cannot be post-triggered.

An active comfort mode extension is displayed by the „ „ or „ „ symbols.

It must be pointed out that the push button with RTR and display in controller extension mode signals only the „comfort“ () symbol even in a comfort mode extension.

An individual temperature setpoint can be preset for each „heating“ or „cooling“ control option ([cf. „4.4 Temperature-setpoints“](#)).

Basically, only one operating mode can be activated at any one time so that in case of two control circuits both circuits will always run in the same mode.

# Push button 2, 3, 5gang with room thermostat (RTR) and display flush-mounted

## 756627xx, 756637xx, 756657xx

### 4.1.1 Operating mode switch-over

There are several ways to activate or switch-over the operating modes. Activating or switching-over – interdependent in terms of priority – is possible via...

- local control on the push button (programming mode), if enabled,
- local control on the push button (rockers 1 to max. 5) and a parameterizable op. mode switch-over,
- the objects that are available separately for each operating mode or alternatively via the KONNEX objects. In the latter case also via a controller extension.

To a):

By activating the programming mode (cf. „1.4 Programming mode/local control“), the „comfort“, „standby“, „night“ or „frost/heat protection“ (absent) operating modes can be optionally activated from the „operating mode switch-over“ menu.

A switch-over into the comfort extension mode is not possible in programming mode!

To b):

In addition to the control in programming mode, it is possible to parameterize the „operating mode switch-over“ function for the push button’s rockers 1 to max. 5 (depending on the projected model) (cf.. „3.2 Rocker functions“). One has to distinguish between rocker or key function:

- Key function:

The function of a key is set to „operating mode switch-over“. In this case it is possible to predefine in the ETS plug-in, which one of the operating modes will be activated by pressing this key. Available are the „comfort“, „standby“, „night“ and „frost/heat protection“ modes.

In order to activate the comfort mode extension, the presence key may be enabled in the ETS plug-in in the „room temperature regulator function – functionality“ parameter branch via the „presence detection“ and „type of presence detection“ parameters. If enabled, the „presence object“ object will appear. The „presence key“ setting can now be selected for the key functions. That way it is possible to switch into the comfort mode extension or to deactivate it prematurely by actuating the presence key while the night or frost/heat protection mode is activated (not activated via the „window status“ object). It is also possible to switch from the standby mode into the comfort mode by actuating the presence key.

The function of the status-LED is parameterizable. In addition to the „Off“, „On“ and „operation indication“ standard settings, the „display operating mode active“ and „display operating mode inactive“ settings may be selected. This allows the status-LED’s to signal whether an operating mode linked with the associated key is activated or not activated. It is not necessary to have the corresponding mode activated or deactivated by a key actuation. Alternatively, the LED can be switched via a separate communication object. The polarity of the status object in the „push button function / general / [key designation] /state of push button“ parameter branch is parameterizable.

- Rocker function:

The function of a rocker is set to „operating mode switch-over“. In this case the operating mode can be switched-over by pressing the left or right rocker key. This will cause to toggle between the „comfort“, „standby“, „night“ and „frost/heat protection“ modes.

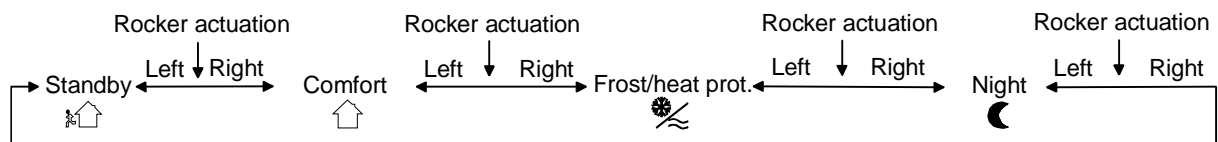

It is not possible to activate a comfort mode extension (presence function) with a rocker function!

As is the case with a push button rocker function, the rocker’s status-LED’s can be controlled via the status object and independent of the room temperature regulator actuation.



**Push button 2, 3, 5gang with room thermostat (RTR) and display flush-mounted**  
**756627xx, 756637xx, 756657xx**

To c):

One distinguishes whether the operating mode is to be switched-over via separate 1-bit objects or, alternatively, via the 1-byte KONNEX objects. The „operating mode switch-over“ parameter in the „room temperature regulator function“ parameter branch predefines how the switch-over will take place.

- Operating mode switch-over via „switching“ (4 x 1-bit):

There is a separate 1-bit switch-over object for each operating mode. Each one of these objects allow to switch-over or to preset the current operating mode by priority.

Taking into consideration the priority, the following switch-over hierarchy results from an operating mode switch-over via the objects. One distinguishes between a presence detection per presence key (table 1 / figure 1) and presence detector (table 2 / figure 2 on next page):

Table 1

“Operating mode switch-over“ objects:				Window status Obj.-No. 34	Presence sensing obj. Obj.-No. 33	activated operating mode
Obj.-No. 31	Obj.-No. 28	Obj.-No. 29	Obj.-No. 30			
X	X	X	X	1	X	Frost /heat protection
1	X	X	X	0	0	Frost /heat protection
0	1	X	X	0	0	Comfort
0	0	1	X	0	0	Standby
0	0	0	1	0	0	Night
1	X	X	X	0	1	Comfort mode extension
0	1	X	X	0	1	Comfort
0	0	1	X	0	1	Comfort
0	0	0	1	0	1	Comfort mode extension
0	0	0	0	0	0	last available mode
0	0	0	0	0	1	Comfort / comfort mode extension *

X = irrelevant

\*: Depends on the last available operating mode.

Figure 1:

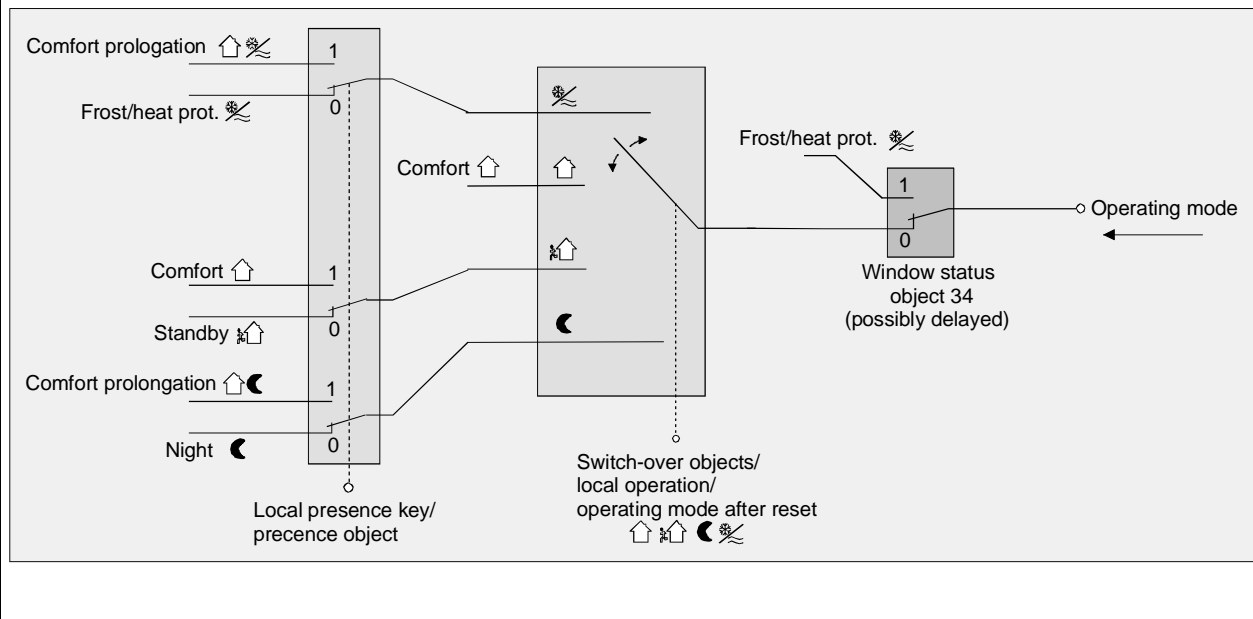



# Push button 2, 3, 5gang with room thermostat (RTR) and display flush-mounted

## 756627xx, 756637xx, 756657xx

Table 2

"Operating mode switch over" objects				Window status Obj. no. 34	Presence detector obj. Obj. no. 33	Activated operating mode
Obj. no. 31	Obj. no. 28	Obj. no. 29	Obj. no. 30			
X	X	X	X	1	X	Frost/heat protection
X	X	X	X	0	1	Comfort
1	X	X	X	0	0	Frost/heat protection
0	1	X	X	0	0	Comfort
0	0	1	X	0	0	Standby
0	0	0	1	0	0	Night
0	0	0	0	0	0	Last valid mode set

X = irrelevant

Figure 2:

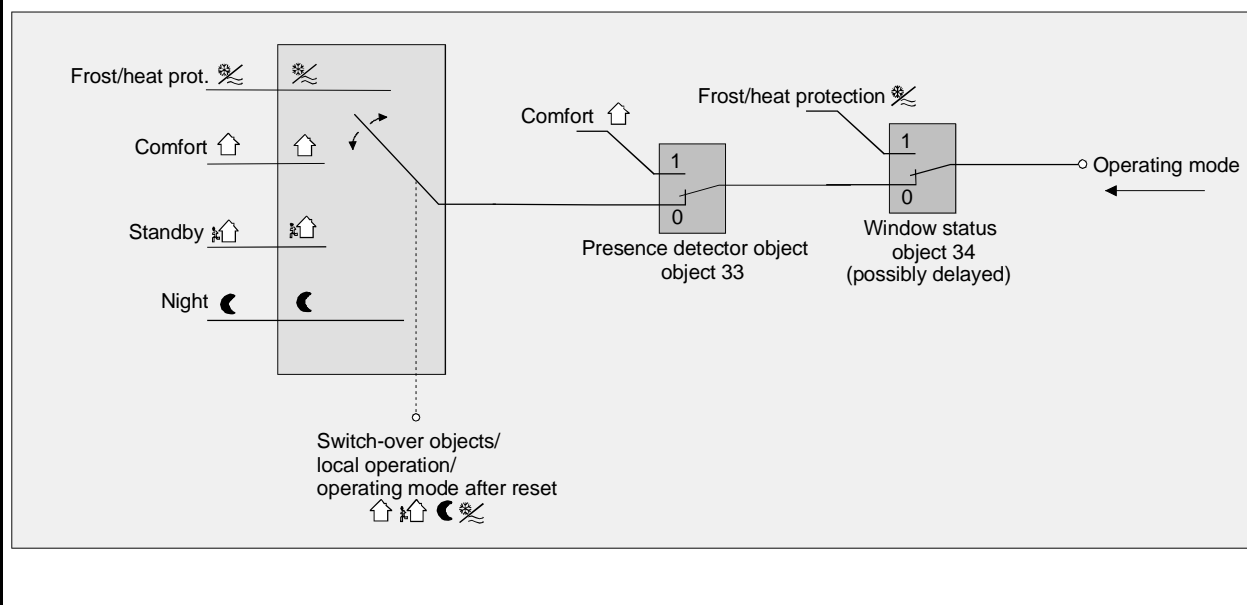

# Push button 2, 3, 5gang with room thermostat (RTR) and display flush-mounted

## 756627xx, 756637xx, 756657xx

Notes on operating mode switch-over via „switching“ (4 x 1-bit):

- When the operating modes are switched-over, the objects, too, (comfort mode / standby mode / night mode / frost / heat protection) will always be updated and can be, if applicable, be read out (set „read“ flag!). Once the „transmission“ flag is set for these objects, changed values will be actively transmitted on the bus. Following a return of bus voltage or an initialization, the object corresponding to the set operating mode will be updated and its value actively transmitted on the bus with flag set to „transmission“.
- Taking into consideration the priorities of the operating modes a switch-over via the objects is on equal terms with a local switch-over on the push button. An operating mode predetermined by an object can be switched-over by an operating mode switch-over on the device using a key or rocker function, if no higher-priority mode (e.g. window contact / presence detector) has been activated.
- When setting parameter values for a presence key:  
The presence object is active (“1”) for as long as the comfort mode extension is activated.  
The presence object will automatically be deleted (“0”), if the comfort mode extension is terminated after the extension time has elapsed or if the operating mode has been switched by a higher-priority control via the switch-over objects or local control.
- If other push buttons are used as an extension for the operating mode switch-over, only those keys or rockers (push button functions) should be used to switch-over, which are parameterized to the „switching“ function. Otherwise (for example with extension parameterization as „operating mode switch-over“) an unwanted operating mode may be activated at the master station (push button with RTR and display as room temperature regulator) due to the priority interpretation of incoming telegrams.  
By using extensions it is recommended to work with the KONNEX operating mode switch-over (see next paragraph). Push buttons RTR can be parameterized for the use as a controller extension.
- Basically, only one operating mode can be activated at any one time so that in case of two control circuits both circuits are in the same mode!  
The operating mode switch-over of the second control circuit always takes place parallel to the switch-over of the first control circuit.

# Push button 2, 3, 5gang with room thermostat (RTR) and display flush-mounted

## 756627xx, 756637xx, 756657xx

- The operating mode switch-over via „value“ (2 x 1-byte):

A shared 1-bit switch-over object exists for all operating modes. Via this value object, the operating mode can instantly switch-over after receiving only one telegram. The received value will determine the operating mode.

In addition, there is a second 1-byte object available which can (forced control and higher ranking) set an operating mode independent of all other available switch-overs. Both 1-byte objects are implemented according to the KONNEX specification.

Taking into account the priorities there are the following switch-over whereas one distinguishes between a presence detection via presence key (table 1 / fig. 1) and presence detector (table 2 / fig. 2 on next page):

“Operating mode switch-over“ object Obj.-No. 28	“Forced object operating mode“ object *** Obj.-No. 32	Window status Obj.-No. 34	Presence sensing object Obj.-No. 33	activated operating mode
X	01	X	X	Comfort
X	02	X	X	Standby
X	03	X	X	Night
X	04	X	X	Frost /heat protection
X	00	1	X	Frost /heat protection
01	00	0	0	Comfort
02	00	0	0	Standby
03	00	0	0	Night
04	00	0	0	Frost /heat protection
01	00	0	1	Comfort
02	00	0	1	Comfort
03	00	0	1	Comfort mode extension
04	00	0	1	Comfort mode extension
00	00	0	0	last available mode
00	00	0	1	Comfort / comfort mode extension *

\*: Depends on the last available operating mode. / X = irrelevant

\*\* : Values greater than „04“ will not be evaluated. A „00“ value will leave the last available operating mode active.

\*\*\*: Values greater than „04“ will not be evaluated. A „00“ value signifies a deactivated forced object.

Figure 1:

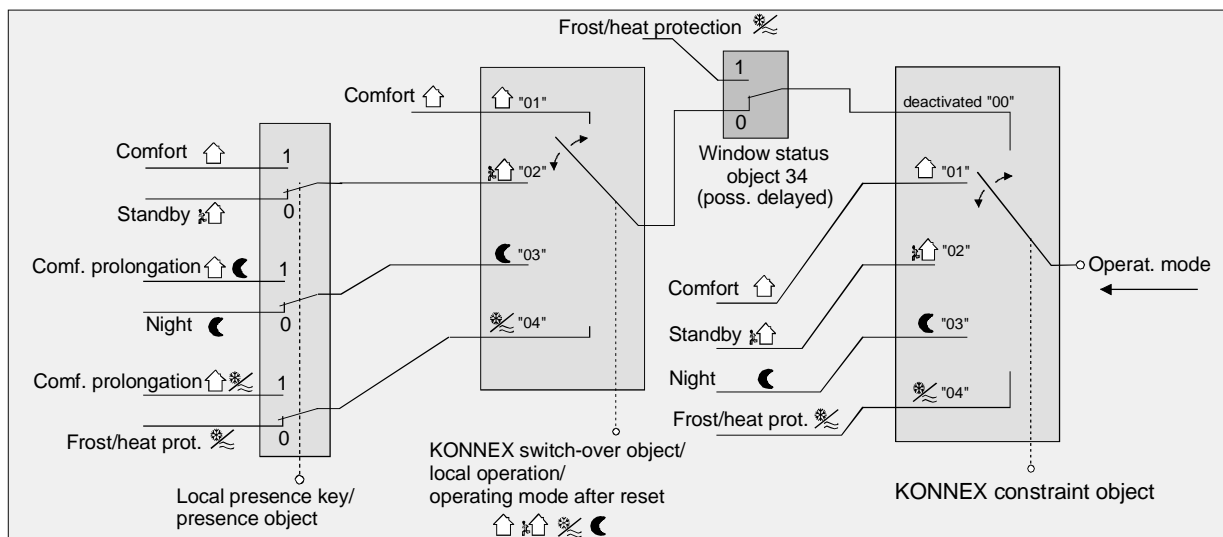

**Push button 2, 3, 5gang with room thermostat (RTR) and display flush-mounted**  
**756627xx, 756637xx, 756657xx**

Table 2

"Operating mode switch-over" object ** Obj.-No. 28	"Forced object operating mode" object *** Obj.-No. 32	Window status Obj.-No. 34	Presence detector object Obj.-No. 33	activated operating mode
X	01	X	X	Comfort
X	02	X	X	Standby
X	03	X	X	Night
X	04	X	X	Frost /heat protection
X	00	1	X	Frost /heat protection
X	00	0	1	Comfort
01	00	0	0	Comfort
02	00	0	0	Standby
03	00	0	0	Night
04	00	0	0	Frost /heat protection
00	00	0	0	last available mode

X = irrelevant

\*\* : Values greater than „04“ will not be evaluated. A „00“ value will leave the last available operating mode active.

\*\*\* : Values greater than „04“ will not be evaluated. A „00“ value signifies a deactivated forced object.

Figure 2:

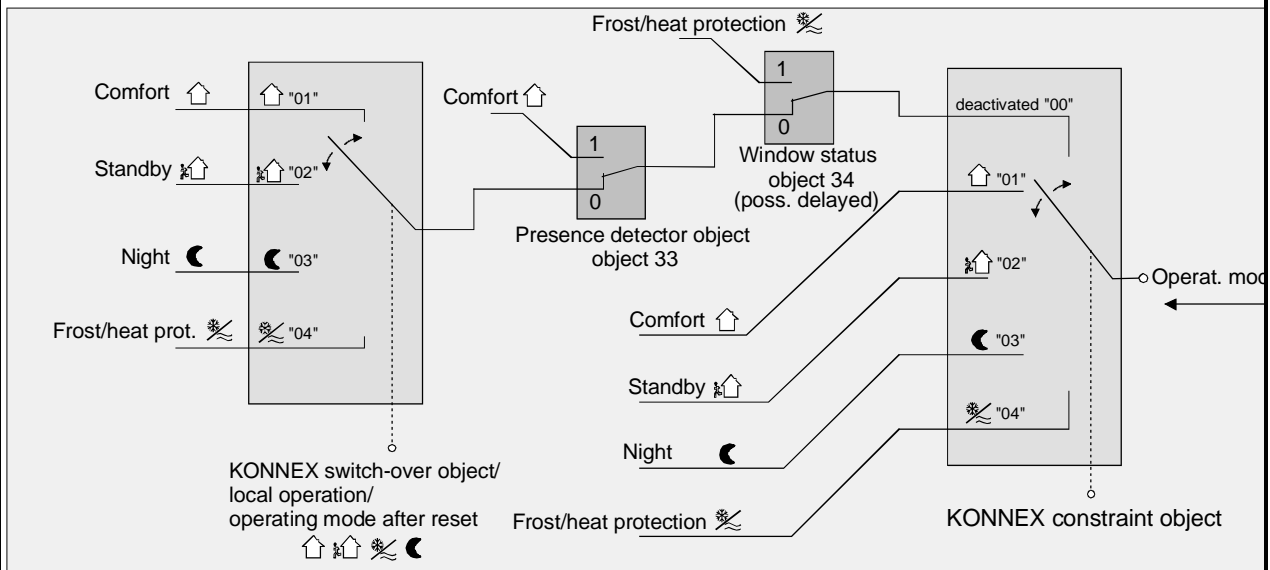

# Push button 2, 3, 5gang with room thermostat (RTR) and display flush-mounted

## 756627xx, 756637xx, 756657xx

Notes for operating mode switch-over via „switching“ (2 x 1-byte):

- Any operating mode switch-over will also update the KONNEX switch-over object and can be, if applicable, read out (set „read“ flag!). If the „transmission“ flag is set with this object, the current value will actively transmitted on the bus following a change. After a return of bus voltage or an initialization, the value corresponding to the adjusted operating mode will be actively transmitted on the bus if flag is set to „transmission“. In case controller extensions are used, the „transmission“ flag must also be set!
- Taking into account the priorities of the operating modes a switch-over via the KONNEX switch-over object is on equal terms with a local switch-over on the push button. An operating mode predetermined by an object can be switched-over via an operating mode switch-over on the device via key or rocker function, if the higher-priority mode (e.g. window contact / presence detector) and the KONNEX forced object is not activated.

The KONNEX forced object has always a higher priority.

- When parameterizing a presence key:  
The presence object is active (“1”) for the duration of an activated comfort mode extension.  
The presence object will automatically be deleted (“0”), if the comfort mode extension is terminated after the elapsed extension time, if the operating mode has been switched by a higher-priority control via the switch-over objects or local control or if a forced operating mode has been deactivated via the KONNEX forced object (forced object → „00“).
- Basically, only one operating mode can be activated so that in the case of two control circuits both circuits will run in the same mode!  
The operating mode switch-over of the second control circuit always takes place parallel to the switch-over of the first control circuit.

#### 4.1.2 Notes on the operating modes

Presence function / comfort mode extension:

Via a presence detection the room temperature regulator may switch into the comfort mode extension for a short time when a key is pressed or may switch into the comfort mode if movement is detected. The „*presence detection*“ and „*type of presence detection*“ parameters in the „*room temperature regulator function – functionality*“ parameter branch determine whether the presence detection is controlled by movement via the presence detector or manually by pressing the presence key:

- Presence detection via presence key:

If the presence key is enabled as the type of presence detection, the „*presence button*“ can be selected with the key functions. In addition, the „*presence object*“ object 33 is enabled.

That way, it is possible to switch into the comfort mode extension or to deactivate it during activated night mode or frost/heat protection (not activated via the „*window status*“ object) by actuating the presence button or via a presence object value = „1“. The extension is automatically deactivated as soon as the parameterized „*length of comfort prolongation*“ has lapsed. A comfort mode extension can be prematurely deactivated, if the presence button is pressed again or if a value = „0“ is received by the object. A post-triggering of the extension time is not possible.

If the duration of the comfort mode extension is set to „0“, it will not be possible to activate a comfort mode extension from the night mode or the frost/heat protection. In this case, the operating mode is not switched even though the presence function is activated.

If the standby mode is active, it is possible to switch into the comfort mode by actuating the presence button or via a presence object value = „1“. This will be also the case if the duration of the comfort mode extension is parameterized to „0“. The active mode remains active for as long as the presence function is activated or until there is another operating mode.

The presence object or the presence function will always be deleted when switching-over into another operating mode or after a forced operating mode has been deactivated (with KONNEX forced switch-over). The presence object is bi-directional („W“ and „T“ flags set to default) so that an activation (= „1“) or a deactivation (= „2“) of the presence function will result in a transmission with the corresponding object value. A presence function including the object that had been activated before a reset will always be deleted after the reset.

- Presence detection by the presence detector:

If a presence detector is enabled for the presence detection, only the „*presence object*“ object 33 will be visible. The presence detectors can be incorporated into the room temperature control via this object.

If any movement is detected („1“ telegram), the controller will switch into the comfort mode. The presetting by the switch-over objects or via local control directly on the push button is not relevant. Only a window contact or the automatic frost protection or the KONNEX forced object have a higher priority. After the delay time in the presence detector has elapsed („0“-Telegramm), the controller switches back into the mode which was active before the presence detection or it will track the telegrams of the switch-over objects received during the presence detection.

Switching-over the operating mode on the push button is not possible while the presence detection is active.

A presence function, which had been activated before a reset, will always be deleted after the reset. In this case the presence detector has to transmit a new „1“ telegram in order to activate the presence function.

Window status / frost protection automatic:

The push button with RTR and display provides different ways to switch into the frost/heat protection. In addition to the switch-over via the appropriate operating mode switch-over object or operating mode switch-over on the push button (key function), the frost protection can be activated via a window contact of the frost/ heat protection or alternatively via a temperature automatic of the frost protection. With these options the window contact or the automatic has the higher priority (cf. „4.1.1 Operating modes switch-over“). The „frost/heat protection“ parameter in the „room temperature regulator function“ parameter branch determines how the higher-priority switch-over takes place.

- Frost/heat protection switch-over „via window status“

The „window status“ object 34 is enabled. A telegram with the value = „1“ (opened window) on this object will activate the frost/heat protection. In this case the operating mode can neither be activated by a local control nor by the switch-over objects (with the exception of the KONNEX forced object). Only a telegram with the value = „0“ (closed window) will reset the window status and deactivate the frost/heat protection. Subsequently, the operating mode, which was set before the opening of the window or tracked via the bus during the time the window was open.

Optionally, a delay of the window status can be parameterized. This delay will be appropriate, if the window is shortly opened for fresh air and shall not cause the operating mode to switch. The delay time is adjusted via the „window status delay“ parameter and can lie between 1 and 255 minutes. Only after the parameterized time has elapsed, the window status and thus the frost/heat protection are activated. The setting „0“ will instantly activate the frost/heat protection with the window opened. The window status is active in the heating and cooling mode. After a reset ("0") the „window status“ object is deleted.

- Frost protection switch-over via „automatic frost protection“:

This setting allows to occasionally switch-over into the frost protection depending on the determined room temperature. If there are no window contacts available, this setting can prevent to unnecessarily raise the room temperature if the windows or outer doors are opened.

This function allows to detect a fast decrease in temperature resulting, for example, from an opened window by measuring the actual-temperature every minute.

As soon as the measured decrease reaches a parameterized value the room temperature regulator will automatically switch into the frost protection mode. The „automatic frost protection“ parameter determines the maximum temperature decrease that will cause the controller to switch-over into the frost protection mode.

As soon as the time has elapsed which was predetermined via the „frost protection period in automatic mode“ parameter, the controller will switch back into the previously set operating mode. A post-triggering is not possible.

In case a switch-over took place during the frost protection via the objects (4 x 1-bit or 1-byte) and a new operating mode was received, this tracked mode will be set following the frost protection automatic.

The KONNEX forced object has a higher priority than the frost protection automatic and may interrupt it.

The frost protection automatic affects only the heating mode for temperatures below the set-temperature of the set operating mode. Thus there can be no automatic frost protection switch-over in the „heating and cooling“ control option with room temperatures in the Dead band or in the active cooling mode. An automatic activation of the heat protection is not intended with this parameterization.

Due to the window contact the frost protection automatic has the same priority during an operating mode switch-over as compared to the alternative setting of the frost/heat protection detection!

Note:

Frequent draft in a room with activated frost protection automatic and a temperature decrease parameterized too low may result in an unwanted activation/deactivation of the frost protection. Principally, the switch-over into the frost/heat protection via window contact is preferable to the automatic!

**Push button 2, 3, 5gang with room thermostat (RTR) and display flush-mounted  
756627xx, 756637xx, 756657xx**

Operation mode after reset:

In the ETS plug-in it is possible to determine in the „*room temperature regulator function – functionality* „ parameter branch via the „*operation mode after reset*“ parameter which operating mode is to be activated following a return of bus voltage, a programming operation via the ETS or a replugging of the user module on the bus coupler. The following settings are possible:

- „*Comfort operation*“:                      After the initialisation phase the comfort mode is activated.
- „*Standby operation*“:                      After the initialisation phase the standby mode is activated.
- „*Night operation*“:                        After the initialisation phase the night mode is activated.
- „*Frost/heat protection operation*“: After the initialisation phase the frost/heat protection is activated.

The objects associated with the activated operating mode will be updated after a reset.



# Push button 2, 3, 5gang with room thermostat (RTR) and display flush-mounted

## 756627xx, 756637xx, 756657xx

### 4.1.3 Controller status

The room temperature regulator is able to transmit its status. Available is either a general collective status report (1-byte) or alternatively one of up to 8 individual status reports (1-bit).

The „*status indication of controller*“ parameter in the „*room temperature regulator function – variable and status output*“ parameter branch releases the status report and determines the status format:

- "status indication of controller" = „controller general“:

The 1-byte status object 36 includes the complete status information. The status - controlled by the control algorithm – is actively transmitted on the bus periodically every 30 seconds (pre-condition: „T“ flag is set!). The setting of the „R“ flag allows the read-out of the status.







Settings	Meaning of data	
Controller general 1-byte	<b>Bit 0:</b> 1: comfort operation active <b>Bit 1:</b> 1: standby operation active <b>Bit 2:</b> 1: night operation active <b>Bit 3:</b> 1: frost/heat protection active	<b>Bit 4:</b> 1: controller disabled <b>Bit 5:</b> 1: heating; 0: cooling <b>Bit 6:</b> 1: controller inactive (Dead band) <b>Bit 7:</b> 1: frost alarm ( $T_{\text{room}} \leq + 5 \text{ }^{\circ}\text{C}$ )

- "Status indication of controller" = „Transmit individual state“:

The 1-bit status object 36 includes the status information selected by the „individual status“ parameter. The status - controlled by the control algorithm – is actively transmitted on the bus periodically every 30 seconds (pre-condition: „T“ flag is set!). The setting of the „R“ flag allows the read-out of the status.

Parameterization for "Individual state"	Relevance of data	
Comfort operation active	1: comfort operation / extension active	0: no comfort operation
Standby operation active	1: standby operation active	0: no standby operation
Night operation active	1: Night operation active	0: no night operation
Frost/ heat protection active	1: frost/heat protection active	0: no frost/heat protection
Controller disabled	1: controller disabled (dew point mode)	0: controller not disabled
Heating/cooling	1: heating mode	0: cooling mode
Controller active	1: controller inactive (Dead band)	0: controller active
Frost alarm	1: frost alarm ( $T_{\text{room}} \leq + 5 \text{ }^{\circ}\text{C}$ )	0: no frost alarm ( $T_{\text{room}} > + 5 \text{ }^{\circ}\text{C}$ )

Meaning of status reports:

- Comfort operation: Active if „comfort ‘‘“, or a comfort mode extension „“, or „“, is activated.
- Standby operation: Active if the „standby ‘‘“, operating mode is activated.
- Night operation: Active if the „night ‘‘“, operating mode is activated.
- Frost/ heat protection: Active if the „frost/heat protection ‘‘“, operating mode is activated.
- Controller disabled: Active if the controller disable is activated (dew point mode).
- Heating/cooling: Active if the heating mode is activated and inactive if cooling mode is activated. (inactive with controller disabled.)
- Controller inactive: Active with „heating and cooling“ control option if the measured room temperature lies within the Dead band. This status information is always „0“ for the individual „heating“ or „cooling“ control options! (inactive if controller is disabled.)
- Frost alarm: Active if the determined room temperature reaches or exceeds + 5 °C. The status report has no significant influence on the controller behaviour.

The status object 36 will be updated following a reset and the initialisation phase. Afterwards, the status is updated every 30 seconds parallel to the calculation of the controller's actuation variable.

#### 4.2 Control options and control option switch-over

The room temperature regulator features up to two control options. These control options determine whether the controller shall address heating systems (individual control option „*heating*“) or cooling systems (individual control option „*cooling*“) via its actuating variable. It is also possible to activate a mixed-mode whereas the controller can switch-over automatically or, alternatively, object controlled between „*heating*“ and „*cooling*“.

Moreover, the controlled operation can be carried out in two stages for addressing an additional heating and cooling device. If controlled in two stages, actuating variables will be calculated separately for the basic and additional stage and transmitted on the bus depending on the deviation between actual and set temperature.

The „*heating/cooling mode*“ parameter in the „*room temperature regulator functions*“ parameter branch determines the heating/cooling mode to be carried out and activates, if applicable, the additional stage(s).

For the individual heating/cooling modes „*heating*“ or „*cooling*“ without additional stage, the controller runs with only one actuating variable. Alternatively, it runs with two actuating variables for the parameterized heating/cooling mode, if the additional stage is activated. Depending on the determined room temperature and the preset set-temperatures of the operating modes (cf. „4.4 Temperature setpoints“) the room temperature regulator decides independently whether heating or cooling energy is required and calculates the control variable for the heating or cooling system (cf. „4.3 Room temp. control and control variables“). Following a reset („*heating*“ or „*cooling*“ mode), the controller will always operate in the heating/cooling mode that was set in the ETS (return of bus volt., new ETS programming or after replugging of user mod).

In the „*heating and cooling*“ mixed-mode the controller is able to address heating and cooling systems. The switch-over behaviour of the heating/cooling modes can be preset:

- "Switch-over between heating and cooling" parameter in the „*room temperature regulator-functions*“ parameter branch is set to „*automatically*“:

Depending on the determined room temperature and the adjusted basic setpoint or Dead band, the heating or cooling mode is automatically activated. If the room temperature lies within the set Dead band, neither heating nor cooling will take place (both actuating variables = „0“). By actuating the display keys on the display, the temperature setpoint (heating) for the activated operating mode is displayed. The room will be cooled down, if the room temperature is greater than the temperature setpoint for cooling. The room will be heated up, if the room temperature is lower than the temperature setpoint for heating.

With an automatic switch-over of the heating/cooling mode, the information can be actively transmitted on the bus via the „*heating/cooling switch-over*“ object 35. The „*Automatic heating/cooling switch-over transmission*“ parameter determines when a heating/cooling mode switch-over is transmitted.

- "On changing the heating/cooling" setting:

In this case a telegram is transmitted solely when switching-over from heating to cooling (object value = „0“) or from cooling to heating (object value = „1“).

- "On changing the output value" setting:

With this setting the current heating/cooling mode will always be transmitted if the output variable has changed. With the actuating variable = „0“ the heating/cooling mode that was last active will be transmitted.

If the determined room temperature lies within the Dead band, the heating/cooling mode activated last will be retained in the object value until the controller is switched-over into the other heating/cooling mode.

With an automatic switch-over the object value can also periodically be output. The „*Cyclical transmission heating/cooling switch-over*“ parameter enables the periodical transmission (setting factor > „0“) and determines the cycle time.

Notes on the automatic switch-over of the heating/cooling mode:

A Dead band that is too narrow might result into a permanent switch-over between heating and cooling. For this reason the Dead band (temperature difference between the set-temperatures for heating and cooling comfort mode) should preferably not be adjusted below the default value.

# Push button 2, 3, 5gang with room thermostat (RTR) and display flush-mounted

## 756627xx, 756637xx, 756657xx

- The „switching-over between heating and cooling“ parameter in the „room temperature regulator-functions“ parameter branch is set to „via object“:

Independent of the Dead band, the heating/cooling mode is controlled via the „*heating/cooling mode switch-over*“ object 35. This type of switch-over may be required, for example, when heating as well as cooling via a single-duct system (combined heating and cooling system). The temperature of the medium in the single-duct system must be changed via the system control. Afterwards, the heating/cooling mode is set via the object (often the single-duct system uses cold water for cooling during the summer, hot water for heating during the winter).

The „*heating/cooling mode switch-over*“ object has the following polarity: „1“: heating; „0“: cooling. After a reset the object value „0“ and the „*heating/cooling switch-over after reset*“ parameter will be activated.

The „*heating/cooling switch-over after reset*“ parameter determines which heating/cooling mode will be activated after a reset. The „*heating*“ or „*cooling*“ setting causes the controller to activate the parameterized heating/cooling mode directly after the initialisation phase. Setting the „*heating/cooling switch-over before reset*“ parameter will activate the heating/cooling mode that was selected before the reset.

If a switch-over takes place via the heating/cooling mode object, the controller will first switch-over into a heating/cooling mode that was set after the reset. The controller will switch-over, if applicable, into the other heating/cooling mode only after the device has received an object update.

Notes on the „*heating/cooling switch-over before reset*“ setting:

- Frequent adjustments of the heating/cooling modes during ongoing operation (e.g. several times a day) may affect the product life of the device as in this case the non-volatile storage (EEPROM) is only designed for less frequent write access.

In mixed-mode it is never possible to heat and cool at the same time (actuating variable > „0“)! The „ $\overline{H}$ “ or „ $\overline{C}$ “ symbols will light up on the display only if a heating/cooling mode requires heating or cooling energy (thus the actuating variable is > „0“).

Heating / cooling message:

Depending on the selected heating/cooling mode it is possible to output the information via separate objects whether heating or cooling energy (thus whether there is heating „ $\overline{H}$ “ or cooling „ $\overline{C}$ “) is currently required.

As long as the actuating variable for heating (cooling) is > „0“, a „1“ telegram is transmitted via the „*heating*“ („*cooling*“) message object. The message telegrams will be reset only, if the actuating variables = „0“ („0“ telegram will be transmitted).

Exception: In case of a 2-point control, the „ $\overline{H}$ “ or „ $\overline{C}$ “ symbols will light up or the message objects for heating and cooling will already become active as soon as the temperature falls short of the temperature setpoint in case of heating or exceeds the temperature setpoint in case of cooling. No allowance is made for the parameterized hystereses (cf. „4.3.1 Control algorithms and calculation of actuation variable“)!

Heating and cooling at the same time is not possible! The messages apply only to control circuit 1!

The message objects may be enabled via the „*indication heating*“ or „*indication cooling*“ parameter in the „*variable and status output*“ parameter branch.

The control algorithm (cf. „4.3 Room temperature control and actuating variables“) controls the message objects. It has to be considered that the actuating variable is calculated solely every 30 seconds (thus updating the message objects every 30 seconds).

### 4.3 Room temperature control and actuating variables

#### 4.3.1 Control algorithms, control circuits and calculation of actuating variable

A comfortable temperature control for a living space requires a special control algorithm, which controls the installed heating or cooling systems. By considering the set-temperatures as well as the actual room temperature, the controller determines the actuating variables, which address the heating or cooling system.

The control system (control circuit) consists of the room temperature regulator, the servo drive or the switching actuator (for the use of electrothermal drives), the actual heating or cooling element (e.g. heaters or cooling ceiling) and the room. This results in the following control section.

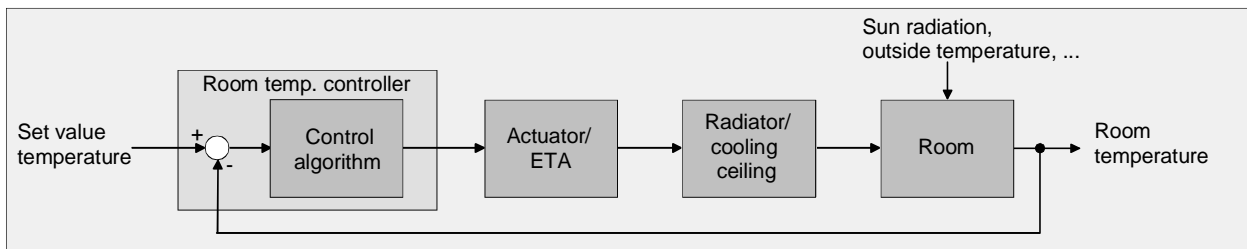

The controller measures the actual-temperature (determined room temperature) and compares it with the given set-temperature. The control algorithm calculates the actuating variable from the difference between actual and set-temperature. This enables the controller to compensate for actual/set-temperature differences in the control circuit caused by external influences (e.g. strong exposure to sun or varying outside temperatures) by regularly readjusting the actuating variable. In addition, the flow temperature of the heating and cooling circuit affects the control section making it necessary to adapt the actuating variables.

The room temperature regulator allows the option between a continuous or switching proportional/integral control (PI) or a switching 2-point control.

In some practical cases it might be necessary to use more than only one control algorithm. Larger systems with underfloor heating, for example, may use a control circuit for constant temperature equalization, which addresses the underfloor heating. The wall-mounted heater, possibly even located in a secondary area of the room will be addressed independently via a separate control algorithm. In these cases it is necessary to distinguish the controls, as underfloor heating systems require mostly other control parameters than more quickly responding heaters. In addition, some cases require the different control sections to have different actuating variables with different object widths (1-bit or 1-byte). Here, the use of a second control circuit is advisable.

The push button with RTR and display provides the option to activate one or, alternatively, two control circuits. The „control circuits“ parameter in the „room temperature regulator function“ parameter branch determines the number of control circuits:

- Control with one control circuit:

The use of only one control circuit allows to parameterize the „heating“, „cooling“ heating/cooling mode or alternatively the „heating and cooling“, mixed mode. Additional stages can be used in all cases. Different control algorithms can be preset for the heating and/or cooling system. Thus, the two-stage heating or cooling mode allows the use of up to four independent algorithms.

- Control with two control circuit:

With two control circuits it is only possible to choose between the „heating“ or „cooling“ heating/cooling mode. Both circuits will always run in the same operating mode (comfort mode, standby mode, etc.). It is, however, possible to preset different control algorithms for the two circuits. This parameterization is not intended for the use of a two-stage control. Both control circuits run optionally with shared or with separate setpoints (cf. „4.4 Temperature setpoints“).

# Push button 2, 3, 5gang with room thermostat (RTR) and display flush-mounted

## 756627xx, 756637xx, 756657xx

The actuating variables calculated by the control algorithm are output via the „*actuating variable heating*“ or „*actuating variable cooling*“ communication objects. The format of the actuating variables, among others, is determined depending on the control algorithm selected for the heating and / or cooling. 1-bit or 1-byte actuating objects may be created (cf. „4.3.3 Actuating variable output“).

The control algorithm is determined via the „*type of heating control*“ or „*type of cooling control*“ parameters in the „*room temperature regulator function*“ parameter branch, possibly also for the additional stages or for both control circuits.

Each of the following three algorithms can be selected:

### 1. Continuous PI control:

A PI control is an algorithm consisting of a proportional and an integral part. A combination of these control characteristics allows to accurately adjust as fast as possible the room temperature without or with only small control deviations.

This algorithm lets the room temperature regulator calculate a new continuous actuating variable periodically every 30 seconds. This one will be output on the bus via a 1-byte value object, if the calculated actuating variable has changed by a predetermined percentage. The „*automatic transmission at modification by...*“ parameter in the „*room temperature regulator function – variable and status output*“ parameter branch determines the change interval in percent.

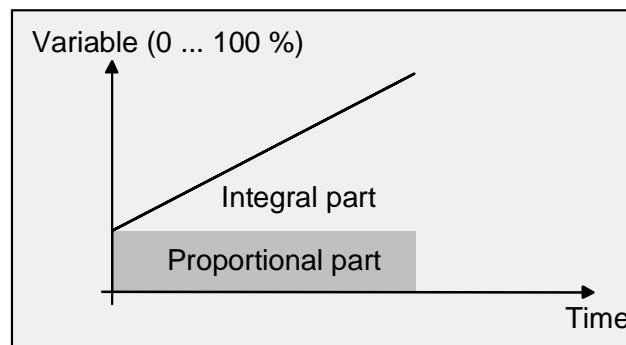

An additional PI controlled heating or cooling stage works exactly as the PI control of the basic stage. The difference is that the setpoint will shift by taking into account the parameterized stage offset.

Characteristic feature of the PI control:

If the set/actual value deviation of the room temperature results in an actuating variable of 100%, the room temperature regulator in the push button with RTR and display uses the maximum actuating variable until the determined room temperature reaches the setpoint. This special control behaviour is known as 'clipping'.

This will quickly heat up or cool down the temperature in chilled or overheated rooms. In two stage heating or cooling systems this control behaviour also applies to the actuating variables of the additional stages.



# Push button 2, 3, 5gang with room thermostat (RTR) and display flush-mounted

## 756627xx, 756637xx, 756657xx

### 2. Switching PI control:

This parameterization will also keep the room temperature constant via the PI control algorithm. Averaged over time, the control system will behave the same as with a continuous controller. The only difference compared to a continuous control is the actuating variable output.

The actuating variable calculated periodically every 30 seconds by the algorithm is internally converted into an equivalent pulse width modulated (PWM) actuating variable signal and output on the bus via a 1-bit switching object after the cycle time.

Allowing for the cycle time which is adjustable via the „*cycle time of the switching variable...*“ parameter in the „*room temperature regulator function – variable and status output*“ parameter branch, the average value resulting from this modulation is a measure for the averaged valve position of the control valve thus making it a reference value for the adjusted room temperature.

Shifting the average value and thus changing the heating output is achieved by changing the pulse duty ratio of the connect and disconnect pulse of the actuating variable signal.

Depending on the calculated actuating variable, the controller adapts the pulse duty ratio solely at the end of a time period! Each change in the actuating variable is realised no matter what the relative change of the actuating variable is (the „*automatic transmission at modification by...*“ and „*cycle time for automatic transmission...*“ parameters have no function here). The actuating variable, which was last calculated within an active time period, will be realised. If the set-temperature changes, for example, due to switching-over into another operating mode, the actuating variable will also be adapted solely at the end of an active cycle time.

The following figure shows the output actuating variable switching signal depending on the actuating variable internally calculated (first 30 %, then 50 % actuating variable; actuating variable output not inverted).

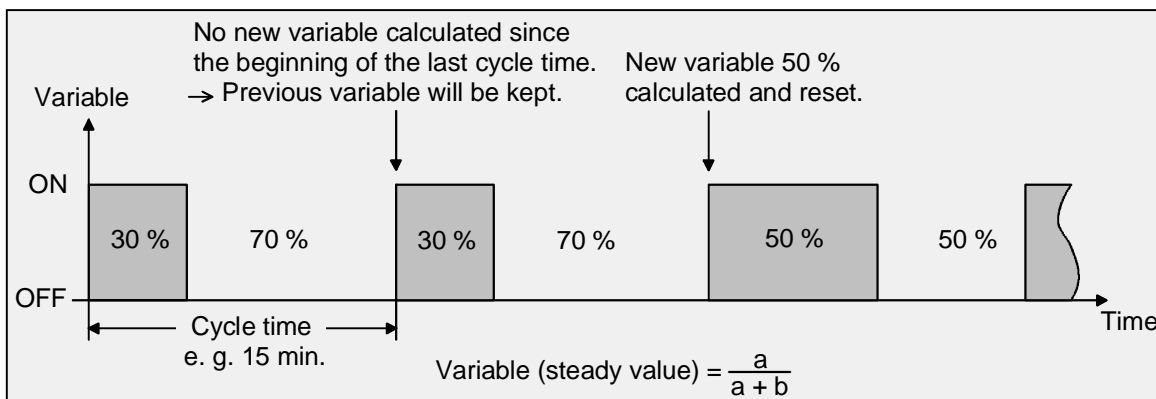

With an actuating variable of 0 % (continuously switched-off) or 100 % (continuously switched-on) an actuating variable telegram according to the actuating variable value ("0" or „1“) is output after a cycle time has elapsed. With this type of control the 'clipping' (cf. „continuous PI control“) is active as well.

Even in case of a switching PI control, the controller always calculates internally with continuous actuating variable values. These continuous values can be additionally output on the bus via a separate 1-byte value object, for example, to display it as status information.

With a switching PI control (PWM), the value object 46 is created for heating and the value object 48 for cooling. If additional stages are used, the value object 47 will be additionally enabled for the additional heating and the value object 49 for the additional cooling. The separate 1-byte value object will not be available if two control circuits are used.

If the actuating variable for heating and cooling is to be output via a shared object (cf. "4.3.3 Actuating variable output"), the continuous value for the activated heating/cooling mode will be transmitted via the object 46 and, if applicable, for the additional stages via the object 47.

The status value objects are only updated after the elapse of the parameterized cycle time together with the actuating output. The „*automatic transmission at modification by...*“ and „*cycle time for automatic transmission...*“ parameters have no function here."

An additional PI controlled heating or cooling stage works exactly the same as the switching PI control of the basic stage. The difference is that the setpoint will shift by taking into account the parameterized stage offset. All PWM controls use the same cycle time.

# Push button 2, 3, 5gang with room thermostat (RTR) and display flush-mounted

## 756627xx, 756637xx, 756657xx

### Cycle time:

In most cases the pulse width modulated actuating variables are used to address electrothermic drives. The room temperature regulator transmits the switching actuating variable telegrams to a switching actuator (preferably with semi-conductor switching elements), which is connected to the drives.

Setting the cycle time for the PWM signal allows to adapt the control to the drives that are being used. The cycle time determines the switching frequency of the pulse modulated signal and allows the adaptation to the adjustment cycle times of the servo drive (traversing time the drive requires to adjust the valve from a completely closed position to a completely opened position). In addition to the adjustment cycle time the dead time (time during which the servo drives show no response when switching on or off) has to be considered. If different drives with different adjustment cycle time are used, the longer time is to be considered. The manufacturer's specifications for the drive have to be followed.

Two cases for the adjustment of the cycle time can be considered:

#### I. Cycle time $> 2 \times$ adjustment cycle time of the drives being used, for example 15 minutes (default)

In this case the connecting or disconnecting times of the PWM signal are sufficiently long enough for the drives to completely open or close within a time period.

##### Advantages:

The desired average value for the actuating variable and thus the required room temperature is relatively accurately adjusted even with several drives that are simultaneously addressed.

##### Disadvantages:

It has to be considered that due to the constantly 'travelled' full valve lift the product life of the drives may decrease. The heat transfer to the room in the vicinity of the heater may be non-uniform and may be felt bothering to some people if there are very long cycle times (15 minutes) and a slow response of the system (for example with smaller hot water heater).

##### Notes:

- This setting for the cycle time is recommended for slower, more inert heating systems (for example underfloor heating).
- This setting is also recommended for a larger number of addressed, possibly different drives making it easier to average the valve travel.

#### II. Cycle time $<$ adjustment cycle time of the drives being used, for example 2 minutes (default)

In this case the short connecting or disconnecting times of the PWM signal are not sufficient for the drives to completely open or close within a time period.

##### Advantages:

This setting ensures a constant water flow through, for example, the heaters allowing a uniform heat transfer to the room.

If only one servo drive is addressed, the controller is able to compensate for the shift of the average value caused by the short cycle time by continuously adapting the actuating variable and is thus able to adjust the desired room temperature.

##### Disadvantages:

If more than one drive is addressed at the same time, the desired average for the actuating variable and thus the required room temperature is adjusted only very poorly or subject to larger deviations.

##### Note:

- This setting for the cycle time is recommended for fast responding heating systems (for example hot water heaters with larger flow temperature).



**Push button 2, 3, 5gang with room thermostat (RTR) and display flush-mounted**  
**756627xx, 756637xx, 756657xx**

3. Switching 2-point control:

The 2-point control represents a very simple type of temperature control. For this type of control, two hystereses temperature values are preset. The controller addresses the actuating elements via switch-on and switch-off actuating variable commands (1-bit). A continuous actuating variable will not be calculated with this type of control. The room temperature is evaluated periodically every 30 seconds as well, i.e. the actuating variables, if required, will change solely during these times. While the 2-point temperature control is very simple, the fluctuating temperature is a disadvantage. For this reason, no fast responding heating or cooling systems should be addressed via a 2-point control as it may result in very strong temperature overshootings and thus to a loss of comfort.

When defining the hystereses limit settings, one has to distinguish between the heating/cooling modes:

- Individual heating/cooling modes „heating“ or „cooling“:

In heating mode the controller will switch-on the heater, if the temperature falls below a preset limit. In heating mode the controller will switch-off the heater only, if an adjusted temperature limit has been exceeded.

In cooling mode the controller will switch-on the cooling, if the room temperature has exceeded a preset limit. In cooling mode the controller will switch-off the cooling only if the temperature has fallen below an adjusted temperature limit.

Depending on the switching state of the actuating variable, a „1“ or „0“ will be output, if the value exceeds or remains under the hystereses limits.

It has to be pointed out that the „ $\overline{1}$ “ or „ $\overline{0}$ “ symbols will light up on the display or that the message objects for heating and cooling will already become active as soon as the temperature falls short of the temperature setpoint in case of heating or exceeds the temperature setpoint in case of cooling. In this case this Hystereses is not being considered.

The upper and lower hystereses limit is to be parameterized in the ETS plug-in for both heating/cooling modes.

The following figure shows a 2-point control for the individual heating/cooling modes „heating“ or „cooling“ (heating on the left, cooling on the right; two temperature setpoints; one-stage heating or cooling; non-inverted actuating variable output):

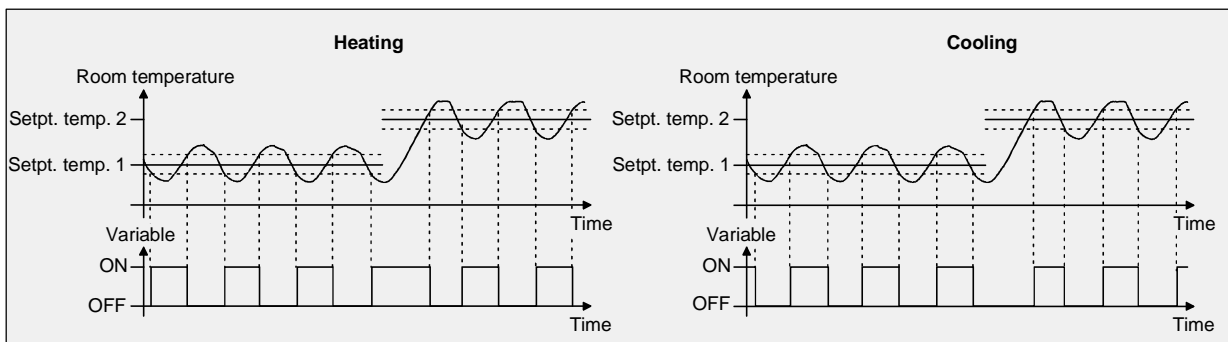

An additional 2-point control heating or cooling stage works exactly the same as the 2-point control of the basic stage. The difference is that the setpoint and the hystereses values will shift by taking into account the parameterized stage offset.

# Push button 2, 3, 5gang with room thermostat (RTR) and display flush-mounted

## 756627xx, 756637xx, 756657xx



- “Heating” and „cooling“ mixed mode:

While in heating mode the controller will switch-on the heater, if the temperature falls below a preset limit. The control will switch-off the heater as soon as the room temperature exceeds the temperature setpoint of the active operating mode.

In cooling mode the controller will switch-on the cooling, if the room temperature has exceeded a preset limit. In cooling mode the controller will switch-off the cooling as soon as the room temperature falls below the temperature setpoint of the active operating mode.

Thus, in mixed-mode operation there is no upper hystereses limit value for heating or no lower hystereses limit value for cooling, as these values would lie in the Dead band. There is neither heating nor cooling within the Dead band.

Depending on the switching state, the actuating variable „1“ or „0“ will be output, if the values exceed or remain under the hystereses limits.

It has to be pointed out that the „“ or „“ symbols will light up on the display or that the message objects for heating and cooling will already become active as soon as the temperature falls short of the temperature setpoint in case of heating or exceeds the temperature setpoint in case of cooling. In this case the hystereses is not being considered.

The upper and lower hystereses limit is to be parameterized in the ETS plug-in for both heating/cooling modes.

The following figure shows a 2-point control for the „heating“ or „cooling“ mixed-mode (activated heating on the left, activated cooling on the right; two temperature setpoints; non-inverted actuating var. output):

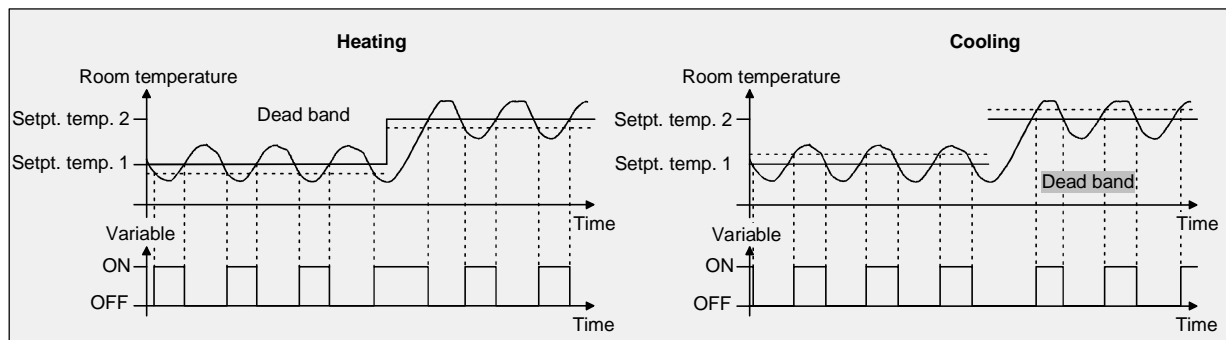

An additional 2-point control heating or cooling stage works exactly the same as the 2-point control of the basic stage. The difference is that the setpoint and the hystereses values will shift by taking into account the parameterized stage offset.

### 4.3.2 Adapting the control algorithms

#### 4.3.2.1 Adapting the PI control

There are several systems available, which may heat or cool a room. One option is to uniformly heat or cool the surroundings via heat transfer media (preferably water or oil) in combination with room air convection. Such systems are used, for example, with wall mounted heaters, underfloor heating or cooling ceilings.

Alternatively or additionally forced air systems may heat or cool rooms. In most cases such systems are electrical forced hot air systems, forced cool air systems or refrigerating compressors with fan. Due to the direct heating of the room air such heating and cooling systems work quite swiftly.

The control parameters need to be adjusted so that the PI control algorithm may efficiently control all common heating and cooling systems thus making the room temperature control work as fast as possible and without deviation.

Certain factors can be adjusted with a PI control that can influence the control behaviour quite significantly at times. For this reason, the room temperature regulator can be set to predefined ‘experience values’ for the most common heating and cooling systems. In case the selection of a corresponding heating or cooling system does not yield a satisfactory result with the default values, the adaptation can optionally be optimized via control parameters.

**Push button 2, 3, 5gang with room thermostat (RTR) and display flush-mounted**  
**756627xx, 756637xx, 756657xx**

Predefined control parameters for the heating or cooling stage and, if applicable, also for the additional stages are adjusted via the „type of heating“ or „type of cooling“ parameters. These fixed values correspond to the practical values of a properly planned and executed air conditioning system and will result in an ideal behaviour of the temp. control. The following types can be set for heating or cooling.

For heating control				
Type of heating	Default values		Recommended Type of PI control:	Recommended PWM cycle time
	Proportional range	Reset-time		
• Hot water heating	5 Kelvin	150 minutes	continuous / PWM	15 minutes **
• Underfloor heating	5 Kelvin	240 minutes	PWM	15 – 20 min.
• Electrical heating	4 Kelvin	100 minutes	PWM	10 – 15 min.
• Forced air convector	4 Kelvin	90 minutes	continuous	---
• Split-unit *	4 Kelvin	90 minutes	PWM	10 – 15 min.
For cooling control				
Type of cooling	Default values		Recommended Type of PI control:	Recommended PWM cycle time
	Proportional range	Reset-time		
• Cooling ceiling	5 Kelvin	240 minutes	PWM	15 – 20 min.
• Forced air convector	4 Kelvin	90 minutes	continuous	---
• Split-unit *	4 Kelvin	90 minutes	PWM	10 – 15 min.

\*: split mobile climate control unit,

\*\* : For smaller, swift working heaters (e.g. higher flow temperature) PWM cycle time 2 – 3 minutes.

If the „type of heating“ or „type of cooling“ parameters are set to „via control parameter“ it will be possible to adjust the control parameter manually. The control may be considerably influenced by presetting the proportional range for heating or for cooling (P part) and the reset-time for heating or for cooling (I part).

Notes:

- Even small adjustments of the control parameters will lead to noticeable different control behaviour.
- The adaptation should start with the control parameter setting for the corresponding heating or cooling system according to the fixed values mentioned above.

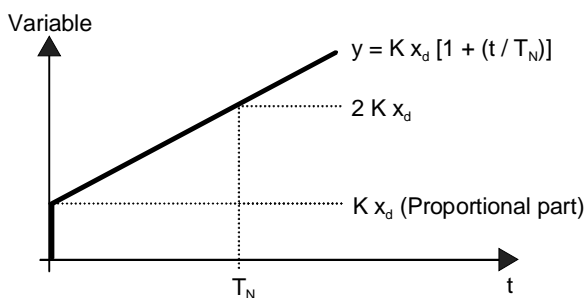

$x_d$  : control difference  $x_d = x_{set} - x_{act}$   
 $P = 1/K$  : parameterizable proportional band  
 $K = 1/P$  : gain  
 $T_N$  : parameterizable reset time

PI control algorithm: Actuating variable  $y = K x_d [1 + (t / T_N)]$ ; By deactiv. the reset-time (setting = „0“):

P control algorithm: Actuating variable  $y = K x_d$

Parameter setting		Effect
P	small proportional range	large overshooting in case of setpoint changes (possibly permanently), quick adjustment to the setpoint
P	large proportional range	no (or small) overshooting but slow adjustment
$T_N$	short reset-time	fast compensation of control deviations (ambient conditions), risk of permanent oscillations
$T_N$	long reset-time	slow compensation of control deviations

#### 4.3.2.2 Adapting the 2-point control

The 2-point control represents a very simple temperature control. For this type of control, two hystereses temperature values are set.

The upper and lower temperature hystereses limits can be adjusted via parameters. It has to be considered that...:

- a small hystereses will lead to small temperature variations but to a higher bus load.
- a large hystereses switches less frequently but will cause uncomfortable temperature variations.

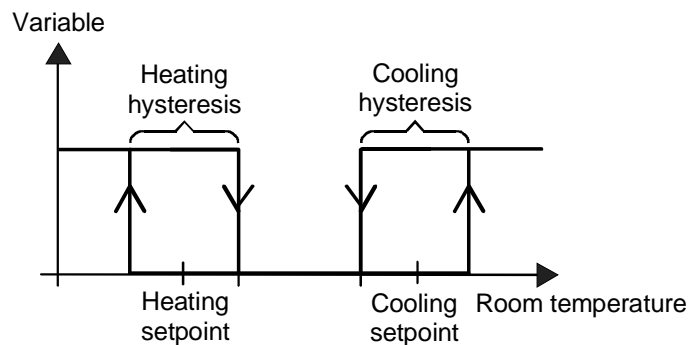
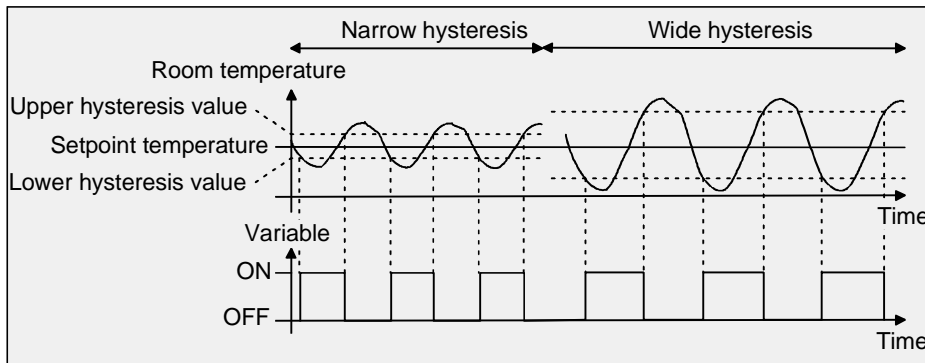

#### 4.3.3 Actuating variable output

##### 4.3.3.1 Actuating variable objects

The format of the actuating variable objects are determined depending on the control algorithm selected for heating and / or cooling and, if applicable, also for the additional stages. 1-bit or 1-byte actuating objects can be created. The control algorithm calculates and outputs the actuating variables in intervals of 30 seconds. With the pulse width modulated PI control (PWM) the actuating variable is updated, if required, solely at the end of a time cycle.

Possible object data formats for the actuating variables separately for both heating/cooling modes, for the basic and the additional stage or for both control circuits are...

- continuous PI control: 1-byte,
- switching PI control: 1-bit + additional 1-byte (for example for the status indication with visualizations),
- switching 2-point control: 1-bit.

Depending on the selected heating/cooling mode, the controller is able to address heating and / or cooling systems, to determine actuating variables and to output them via separate objects. One distinguishes between two cases for the „heating and cooling“ mixed-mode:

Case 1: Heating and cooling system are two separate systems.

In this case the „send variable heating and cooling to one common object“ parameter should be set to „no“ (default) in the „room temperature regulator functions“ parameter branch. Thus, there are separate objects available for each actuating variable, which can be separately addressed via the individual systems. This setting allows to define separate types of control for heating and cooling.

Case 2: Heating and cooling system are a combined system.

In this case the „send variable heating and cooling to one common object“ parameter may be set, if required, to „yes“ in the „room temperature regulator functions“ parameter branch. This will transmit the actuating variables for heating and cooling to the same object. In case of a two-stage control, another shared object will be enabled for the additional stages for heating and cooling. With this setting it is only possible to define the same type of control for heating and for cooling as the control and the data format must be identical. The (*“type of heating / cooling”*) control parameter for cooling and heating still has to be defined separately.

A combined actuating variable object may be required, for example, if heating as well as cooling shall take place via a single-duct system (combined heating and cooling system). For this, the temperature of the medium in the single-duct system must be changed via the system control. Afterwards the heating/cooling mode is set via the object (often the single-duct system uses cold water for cooling during the summer, hot water for heating during the winter).

Note:

Basically, it is not possible to heat and cool at the same time (actuating variable > „0“)!

If required, the actuating variable can be inverted before the transmission. The actuating variable value will be invertedly output according to the object data format via the „output of the heating variable“ or „output of the cooling variable“ parameters or via a combined „output of the variable“ object. The parameter for inverting the additional stage(s) are additionally available in the two stage controlled operation.

The following applies...

for continuous actuating variables:	not inverted:	Actuating variable 0 % ... 100 %, Value 0 ... 255,
	inverted:	Actuating variable 0 % ... 100 %, Value 255 ... 0,
for switching actuating variables:	not inverted:	Actuating variable on / off, Value 0 / 1,
	inverted:	Actuating variable on / off, Value 1 / 0.

#### 4.3.3.2 Automatic transmission

- Continuous PI control:

In case of a continuous PI control the room temperature regulator calculates a new actuating variable periodically every 30 seconds and outputs them on the bus via a 1-byte value object. The change interval of the actuating variable can be determined in percent according to which a new actuating variable is to be output on the bus via the „*automatic transmission at modification by...*“ parameter in the „room temperature regulator function –variables and status output“ parameter branch. The change interval can be parameterized to „0“ so that a change in the actuating variable will not result in an automatic transmission.

In addition to the actuating variable output following a change, the current actuating variable value may be periodically transmitted on the bus. In addition to the times when changes are to be expected, other actuating variable telegrams will be output according to the active value after a parameterizable cycle time.

This will ensure that telegrams are received within the control interval during a periodic access control of the actuating variable in servo drive or in the addressed switching actuator. The time interval preset by the „cycle time for automatic transmission...“ parameter should correspond to the control interval in the actuator (cycle time in the controller is preferably to be parameterized smaller).

The „0“ setting will deactivate the periodic transmission of the actuating variable.

If the periodic and the automatic transmission are both deactivated, no actuating telegrams will be transmitted in case of a change!

- Switching PI control (PWM):

In case of a switching PI control (PWM), the room temperature regulator calculates a new actuating variable internally every 30 seconds. The update of the actuating variable, however, takes place, if required, solely at the end of a cycle. The „automatic transmission at modification by...“ and „cycle time for automatic transmission...“ parameters are not enabled with this control algorithm.

- 2-point control:

In case of a 2-point control, the room temperature and thus the hystereses values are evaluated periodically every 30 seconds, so that the actuating variables, if required, will change solely during these times. The „automatic transmission at modification by...“ parameter is not enabled as this control algorithm does not calculate continuous actuating variables.

In addition to the actuating variable output following a change, the current actuating variable value may be periodically transmitted on the bus. In addition to the times when changes are to be expected, other actuating variable telegrams will be output according to the active value after a parameterizable cycle time.





This ensures that during a periodic access control of the actuating variable in servo drive or in the addressed switching actuator, telegrams are received within the control interval. The time interval predetermined by the „cycle time for automatic transmission...“ parameter should correspond to the control interval in the actuator (cycle time in the controller is preferably to be parameterized smaller).

The „0“ setting will deactivate the periodic transmission of the actuating variable.



#### 4.4 Temperature setpoints

##### 4.4.1 Setpoint presettings in the ETS

Temperature setpoints can be preset for each operating mode. It is possible to parameterize the setpoints for the „comfort , „standby , und „night , modes in the ETS plug-in. If desired, the set-temperatures can be subsequently adjusted via local control in programming mode or via object control. The „frost/heat protection , operating mode allows the separate parameterization of two temperature setpoints for heating (frost protection) and cooling (heat protection) solely in the ETS.

When presetting the set-temperatures for comfort, standby and night mode attention has to be paid to the fact that all setpoints depend on each other as all values are derived from the basic temperature (basic setpoint). The „*basic temperature after reset*“ parameter in the „*set point values*“ parameter branch determines the basic setpoint, which is loaded when the device is programmed via the ETS.

Taking into account the „*lower / raise the setpoint temperature in standby mode*“ or „*lower / raise the setpoint temperature in night mode*“ parameters the temperature setpoints for the standby and night mode are derived from this value depending on the heating or cooling heating/cooling mode. The Dead band will be additionally considered for the „*Heating and cooling*“ mode.

In two-stage control mode, all set-temperatures of the additional stage are derived from the set-temperatures of the basic stage. The set-temperatures of the additional stage are determined by subtracting the „*difference between basic and additional stages*“, which is parameterized in the ETS plug-in, from the setpoints of the basic stage in heating mode or by adding the setpoints in cooling mode. If the temperature setpoints of the basic stage are changed either in programming mode on the push button or by setting a new basic setpoint, the set-temperatures of the additional stage will be indirectly and automatically changed as well. Both stages will heat or cool with the same actuating variable at the same time when the setpoint difference is „0“.

When using two control circuits it is possible to set shared setpoints or alternatively separate values for both circuits. The „*own setpoints for the 2<sup>nd</sup> control circuit*“ parameter in the „*room temperature regulator function – set point values*“ parameter branch determine the setpoints:

- Settings: „no“ (default):

Both control circuits have the same setpoints for the comfort, standby and night mode. The frost or heat protection temperatures are identical as well. This setting features, if enabled, a shared object for setting the basic setpoints and an object for transmitting the set-temperature on the bus.

- Setting „yes“:

Independent of each, both control circuits have their own setpoints for the comfort, standby and night mode. Only the frost or heat protection temperatures are identical. With this setting there are separate objects per control circuit available for setting the basic setpoint or transmitting the set-temperature, if enabled. A change of the set-temperature in programming mode on the push button is only possible for the first control circuit.

The operating mode switch-over of the second control circuit always takes place parallel to the switch-over of the first control circuit. It is not possible to have a two-stage control and a mixed-mode of heating and cooling with two control circuits.

Depending on the heating/cooling mode, the relationships described on the following pages have to be considered for the set-temperatures.

When using two control circuits the heating/cooling mode for both circuits can be set to either „heating“ or „cooling“. In this case, it is not possible to have a „heating and cooling“ mixed-mode!



4.4.1.1 Setpoints for the „heating“ heating/cooling mode

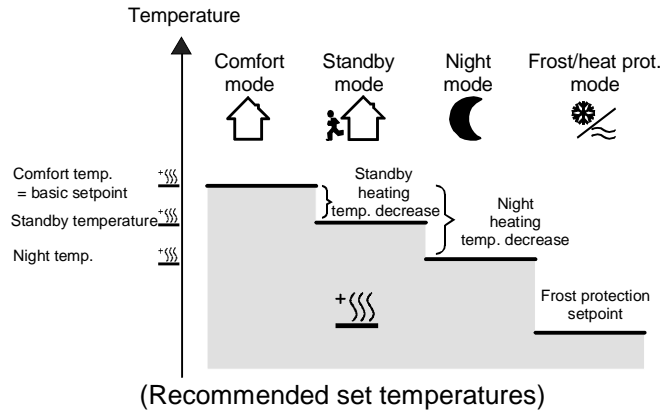

The set-temperatures for comfort, standby and night mode exists for this heating/cooling mode. The frost protection temperature can be preset. The following applies:

$$T_{\text{Standby set value heating}} \leq T_{\text{Comfort set value heating}} \quad \text{or} \quad T_{\text{Night set value heating}} \leq T_{\text{Comfort set value heating}}$$

The standby and night set-temperatures are derived after the parameterized decrease-temperatures from the comfort set-temperature (basic setpoint). It is also possible to adjust other decrease-temperatures via local control in programming mode on the controller, if enabled, by changing the set-temperature values for night and standby mode (cf. „1.4 Programming mode / local control“). This local control is only possible for control circuit 1!

The frost protection is supposed to prevent the heating system from freezing. For this reason the frost protection temperature should be set to a smaller value than the night temperature for heating (default: +7 °C). In principle, however, it is possible to select frost protection temperature values between +7 °C and +40 °C.

The possible range of values for a set-temperature lies between + 7,0 °C and + 99,9 °C for „heating“ and is bounded by the frost protection temperature in the lower range.

The stage offset parameterized in the ETS plug-in will be add. considered in a two-stage heating mode.

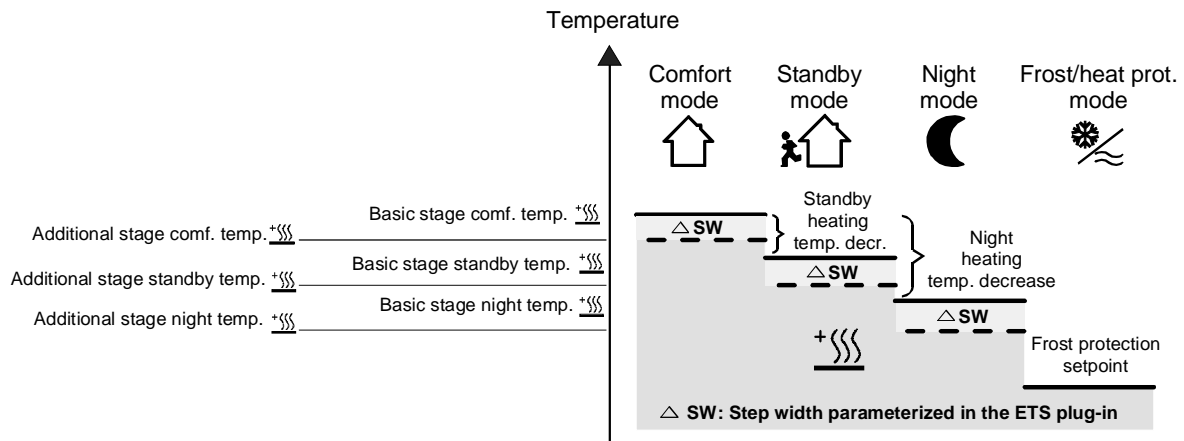

$$T_{\text{Comfort set value additional stage heating}} \leq T_{\text{Comfort set value basic stage heating}} / T_{\text{Standby set value additional stage heating}} \leq T_{\text{Standby set value basic stage heating}}$$

$$T_{\text{Standby set value heating}} \leq T_{\text{Komfort set value heating}}$$

or

$$T_{\text{Comfort set value additional stage heating}} \leq T_{\text{Comfort set value basic stage heating}} / T_{\text{Night set value additional stage heating}} \leq T_{\text{Night set value basic stage heating}}$$

$$T_{\text{Night set value heating}} \leq T_{\text{Comfort set value heating}}$$

4.4.1.2 Setpoints for the „cooling“ heating/cooling mode

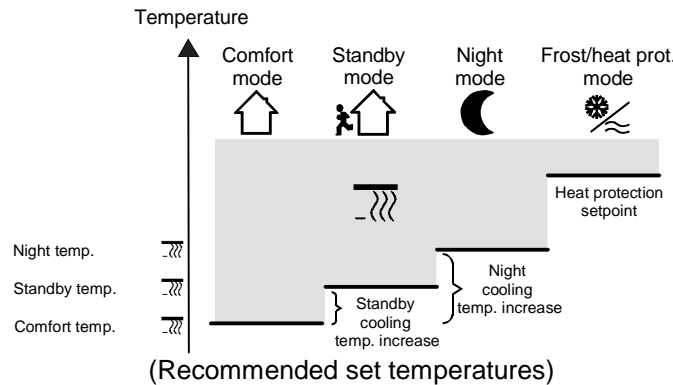

The set-temperatures for comfort, standby and night mode exists for this heating/cooling mode. The heat protection temperature can be preset. The following applies:

$$T_{\text{Comfort set value cooling}} \leq T_{\text{Standby set value cooling}} \quad \text{or} \quad T_{\text{Comfort set value cooling}} \leq T_{\text{Night set value cooling}}$$

The standby and night set-temperatures are derived after the parameterized increase-temperatures from the comfort set-temperature (basic setpoint). It is also possible to adjust other increase-temperatures via local control in programming mode on the controller, if enabled, by changing the set-temperature values for night and standby mode (cf. „1.4 programming mode / local control“). This local control is only possible for control circuit 1!

The heat protection is supposed to prevent the temperature from exceeding the maximum permissible room temperature in order to protect system components. For this reason, the heat protection temperature should be set to a larger value than the night temperature (default: +35 °C). In principle, however, it is possible to select heat protection temperature values between +7 °C and +45 °C. The possible range of values for a set-temperature lies between - 99,9 °C and + 45,0 °C for „cooling“ and is bounded by the heat protection temperature in the upper range.

The stage offset parameterized in the ETS plug-in will be add. considered in a two stage cooling mode.

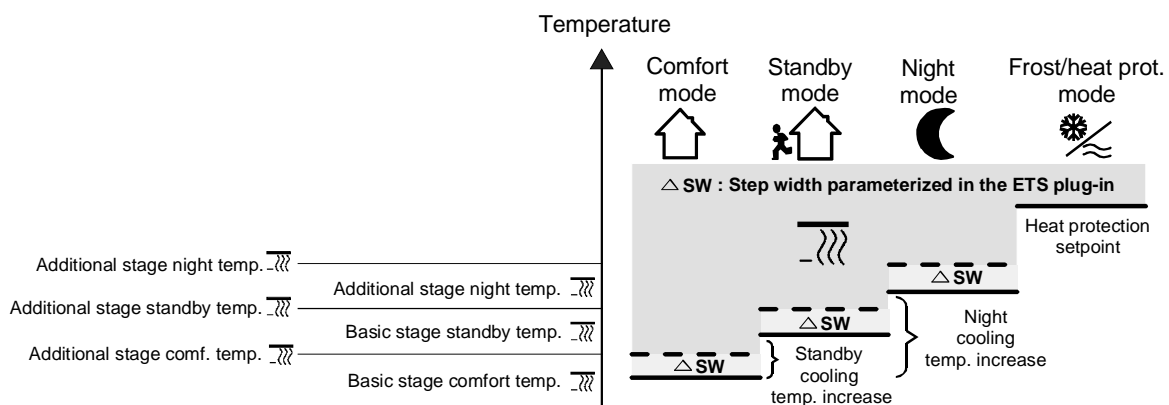

$$T_{\text{Comfort set value basic stage cooling}} \leq T_{\text{Comfort set value additional stage cooling}} \quad / \quad T_{\text{Standby set value basic stage cooling}} \leq T_{\text{Standby set value additional stage cooling}}$$

$$T_{\text{Comfort set value cooling}} \leq T_{\text{Standby set value cooling}}$$

or

$$T_{\text{Comfort set value basic stage cooling}} \leq T_{\text{Comfort set value additional stage cooling}} \quad / \quad T_{\text{Nacht set value basic stage cooling}} \leq T_{\text{Nacht set value additional stage cooling}}$$

$$T_{\text{Comfort set value cooling}} \leq T_{\text{Night set value cooling}}$$

**Push button 2, 3, 5gang with room thermostat (RTR) and display flush-mounted**  
**756627xx, 756637xx, 756657xx**

4.4.1.3 Setpoint for the „heating and cooling“ heating/cooling mode:

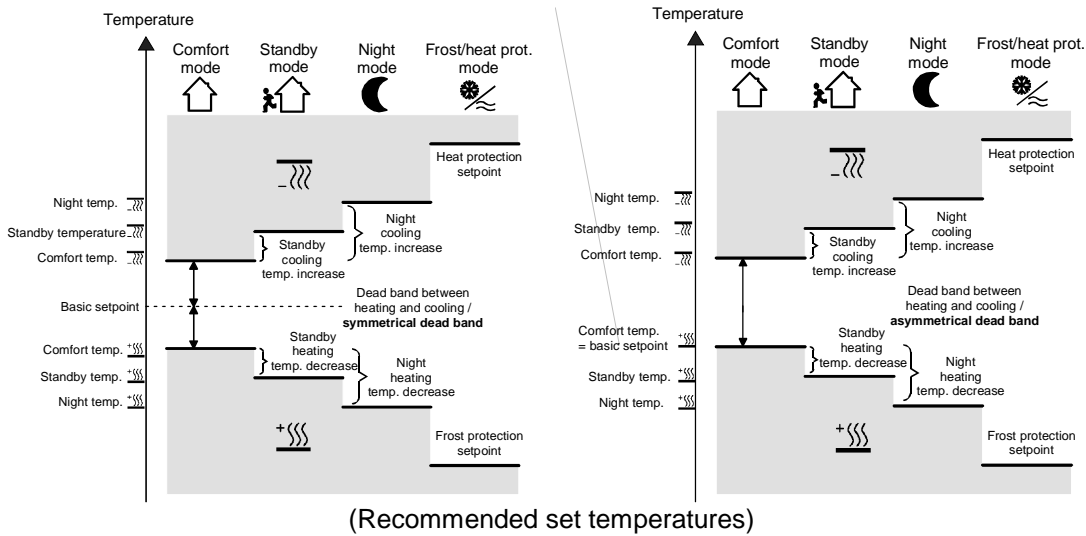

For this heating/cooling mode, the set-temperatures of both heating/cooling modes exist for comfort, standby and night mode as well as the Dead band. In addition, the frost protection and the heat protection temperatures can be preset. The following applies:

$$T_{\text{Standby set value heating}} \leq T_{\text{Comfort set value heating}} \leq T_{\text{Comfort set value cooling}} \leq T_{\text{Standby set value cooling}}$$

or

$$T_{\text{Night set value heating}} \leq T_{\text{Comfort set value heating}} \leq T_{\text{Comfort set value cooling}} \leq T_{\text{Night set value cooling}}$$

The set-temperatures for „Standby“ and „Night“ are derived from the comfort set-temperatures for heating or cooling. The temperature increase (for cooling) and the temperature decrease (for heating) of both operating modes can be preset in the ETS plug-in. The comfort temperatures itself are derived from the Dead band and the basic setpoint (cf. "Dead band" on the following page).

Note:

It is also possible to adjust other decrease or increase-temperatures via local control in programming mode on the controller, if enabled, by changing the set-temperature values for night and standby mode (cf. „1.4 Programming mode / local control“). This local control is only possible for control circuit 1!

The frost protection is supposed to prevent the heating system from freezing. For this reason the frost protection temperature should be to a set smaller value than the night temperature for heating (default: +7 °C). In principle, however, it is possible to select frost protection temperature values between +7 °C and +40 °C.

The heat protection is supposed to prevent the temperature from exceeding the maximum permissible room temperature in order to protect system components. For this reason the heat protection temperature should be set to a larger value than the night temperature for cooling (default: +35 °C). In principle, however, it is possible to select heat protection temperature values between +7 °C and +45 °C.

The possible range of values for a set-temperature („heating and cooling“) lies between + 7 °C and + 45,0 °C and is bounded by the frost protection temperature in the lower range and by the heat protection temperature in the upper range.

# Push button 2, 3, 5gang with room thermostat (RTR) and display flush-mounted

## 756627xx, 756637xx, 756657xx

The stage offset parameterized in the ETS plug-in will be additionally considered in a two-stage cooling mode.

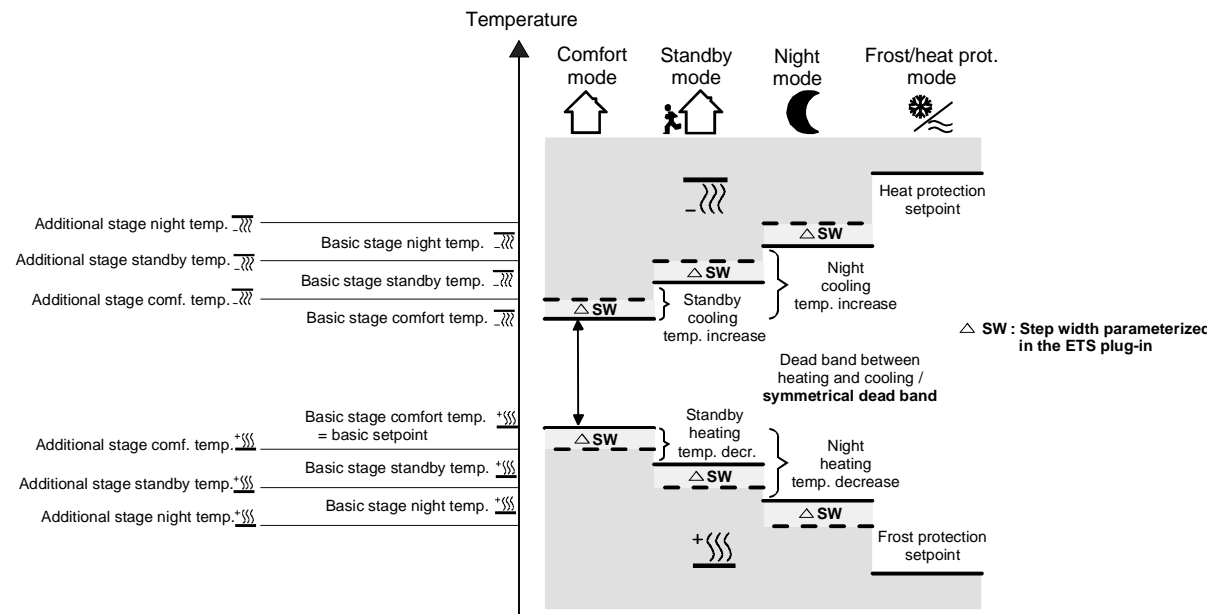
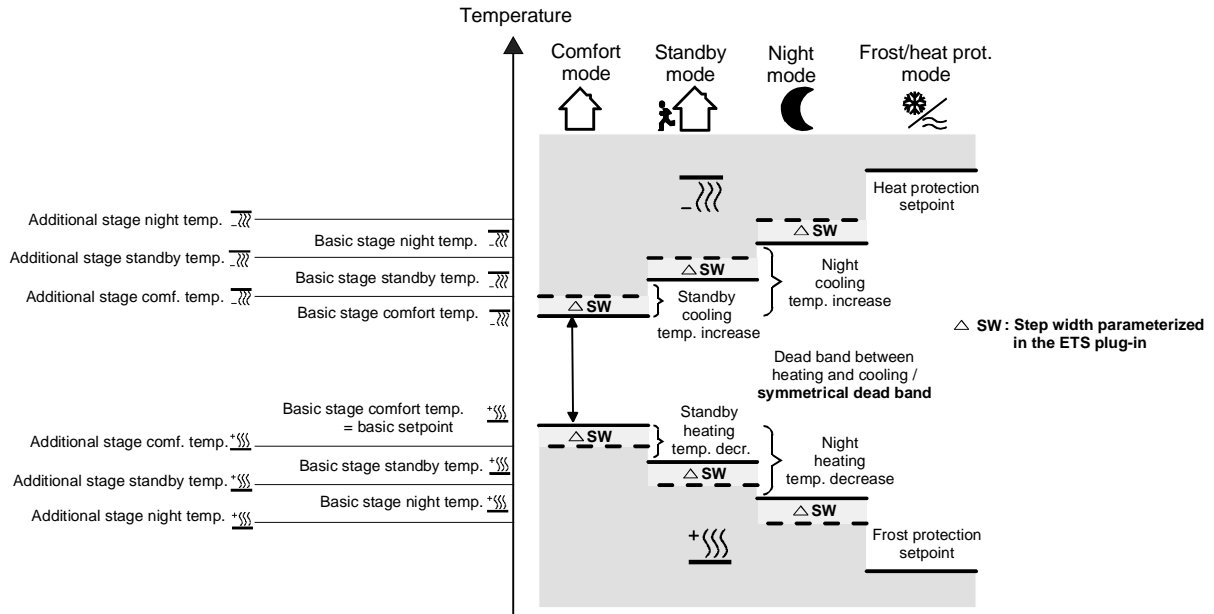

$$T_{\text{Comfort set value additional stage heating}} \leq T_{\text{Comfort set value basic stage heating}} \leq T_{\text{Comfort set value basic stage cooling}} \leq T_{\text{Comfort set value additional stage cooling}}$$

$$T_{\text{Standby set value additional stage heating}} \leq T_{\text{Standby set value basic stage heating}} \leq T_{\text{Standby set value basic stage cooling}} \leq T_{\text{Standby set value additional stage cooling}}$$

$$T_{\text{standby set value heating}} \leq T_{\text{Comfort set value heating}} \leq T_{\text{Comfort set value cooling}} \leq T_{\text{Standby set value cooling}}$$

or

$$T_{\text{Comfort set value Zusatzstufe Heizen}} \leq T_{\text{Comfort-set value basic stage heating}} \leq T_{\text{Comfort set value set value cooling}} \leq T_{\text{Comfort set value additional stage cooling}}$$

$$T_{\text{Night set value additional stage heating}} \leq T_{\text{Night set value basic stage heating}} \leq T_{\text{Night set value basic stage cooling}} \leq T_{\text{Night set value additional stage cooling}}$$

$$T_{\text{Night set value heating}} \leq T_{\text{Comfort set value heating}} \leq T_{\text{Comfort set value cooling}} \leq T_{\text{Night set value cooling}}$$

Dead band:

The comfort set-temperatures for heating and cooling are derived from the basic setpoint in consideration of the adjusted Dead band. The Dead band (temperature zone for which there is neither heating nor cooling) is the difference between the comfort set-temperatures.

The „*dead band between heating and cooling*“, „*dead band position*“ parameters as well as the „*basic temperature after reset*“ parameter are preset in the ETS plug-in. One distinguishes between the following settings:

Dead band = „*symmetrical*“ (default):

The Dead band preset in the ETS plug-in is divided into two parts at the basic setpoint. The comfort set-temperatures are derived directly from the basic setpoint resulting from the half Dead band. The following applies:

$$T_{\text{Basic set value}} - \frac{1}{2}T_{\text{Dead band}} = T_{\text{Comfort set value heating}} \quad \text{or} \quad T_{\text{Basic set value}} + \frac{1}{2}T_{\text{Dead band}} = T_{\text{Comfort set value cooling}}$$

$$\rightarrow T_{\text{Comfort set value cooling}} - T_{\text{Comfort set value heating}} = T_{\text{Dead band}}; T_{\text{Comfort set value cooling}} \geq T_{\text{Comfort set value heating}}$$

Important notes on the symmetrical Dead band:

- In case of a symmetrical Dead band, the basic setpoint is indirectly set via the comfort temperature for heating (local control in programming mode). For this reason the basic setpoint is not shown on the display!
- Changing the comfort set-temperature for cooling allows the adjustment of the Dead band with local control, if enabled (Dead band shifting). An adjustment of the Dead band with a symmetrical dead band position will result in a shifting of the comfort set-temperature for heating and thus of all other temperature setpoints. It is possible to preset the Dead band to 0 °C (result:  $T_{\text{Comfort set value cooling}} = T_{\text{Comfort set value heating}}$ ). In this case there is neither heating nor cooling, if the determined room temperature equals the comfort set-temperatures.

Dead band position = „*asymmetrical*“:

With this setting the comfort set-temperature for heating equals the basic setpoint! The Dead band preset in the ETS plug-in is effective only from the basic setpoint in the direction of comfort temperature for cooling. Thus the comfort set-temperature for cooling is derived directly from the comfort setpoint for heating. The following applies:

$$T_{\text{Basic set value}} = T_{\text{Comfort set value heating}} \quad \rightarrow \quad T_{\text{Basic set value}} + T_{\text{Dead band}} = T_{\text{Comfort set value cooling}}$$

$$\rightarrow T_{\text{Comfort set value cooling}} - T_{\text{Comfort set value heating}} = T_{\text{Dead band}}; T_{\text{Comfort set value cooling}} \geq T_{\text{Comfort set value heating}}$$

Important notes on the asymmetrical Dead band:

- Changing the comfort set-temperature for cooling allows the adjustment of the Dead band with local control, if enabled (Dead band shifting). With an asymmetrical dead band position, an adjustment of the comfort set-temperature for cooling will only shift the temperature setpoints for cooling. It is possible to preset the Dead band to 0 °C (result:  $T_{\text{Comfort set value cooling}} = T_{\text{Comfort set value heating}}$ ). In this case there is neither heating nor cooling, if the determined room temperature equals the comfort set-temperatures.

#### 4.4.2 Adjusting the setpoints

##### 4.4.2.1 Adjusting basic temperature and set temperatures for comfort, standby and night mode

When presetting the set-temperatures for comfort, standby and night mode, attention has to be paid to the fact that all setpoints depend on each other as all values are derived from the basic temperature (basic setpoint). The „basic temperature after reset“ parameter in the „set point values“ parameter branch determines the basic setpoint, which is loaded when the device is programmed via the ETS.

It is possible to change or adjust the set-temperatures 'later' via local control in programming mode on the controller or via object control ("*basic setpoint*" object). After the programming, the set-temperatures of the second control circuit can only be adjusted via object control.

Any change must always be enabled in the ETS plug-in in the „*setpoints*“ parameter branch. It is possible...

- to permit the „*modification of the basic temperature setpoint value*“ by directly changing the comfort temperature for heating on the device (local; only control circuit 1) and/or by setting a new basic setpoint via the bus (object 26 for control circuit 1 / object 27 for control circuit 2,
- to allow the „*1st control circuit standby temperature change*“ by directly changing the standby temperatures for heating or cooling of the first control circuit only on the device (local).
- to permit the „*1st control circuit night temperature change*“ by directly 1st control circuit night temperature changes for heating or cooling of the first control circuit only on the device (local).
- to enable the „*Dead band shifting*“ by changing the comfort set-temperature for cooling only on the device (local; control circuit 1 when „heating and cooling“) and
- to prevent the „*modification of the setpoints 'cooling'*“, in programming mode on the device when in mixed-mode.

If a change is not enabled (setting: „deactivated“), a 'subsequent' adjustment of the value predetermined by the ETS cannot take place and setting the corresponding temperature values locally will not be possible.

In case the basic setpoint adjustment via the bus is disabled, the object 26 or 27 will be hidden.

# Push button 2, 3, 5gang with room thermostat (RTR) and display flush-mounted

## 756627xx, 756637xx, 756657xx

Adjusting the basic setpoint / comfort temperature for heating:

One has to distinguish between two cases only if the basic setpoint has been adjusted, (via local control and/or via the object):

- Case 1: The basic setpoint adjustment is permanently accepted,
- Case 2: The basic setpoint adjustment is only temporarily accepted (default).

Via the „accept modification of the basic temperature setpoint value permanently“ parameter in the „room temperature regulator function / set point values“ parameter branch it is possible to determine whether the set basic temperature value shall be stored in memory permanently (“Yes”) or only temporarily (“No”).

### Case 1:

If the basic temperature setpoint of the first or second control circuit is adjusted, it will be permanently stored in the push button's EEPROM memory. The newly adjusted value will overwrite the basic set-temperature originally parameterized via the ETS! This is the only way to keep the adjusted basic setpoint even after switching-over the operating mode or after a reset.

### Notes:

- Frequent adjustments of the basic temperature (e.g. several times a day) can affect the product life of the device as the non-volatile storage (EEPROM) is designed for less frequent write access.
- Any value that is preset via local control will not be accepted into the object 26.
- The stored basic setpoint will still be active after the return of bus voltage. The value of the object 26 or 27, however is „0“. The current basic setpoint can be read out only after an external object update (set „R“ flag!).

### Case 2:

The basic setpoint, which was set on the push button or received via the object, stays only temporarily active in the current operating mode. In case of a bus voltage failure or following a switch-over into another operating mode (e.g. comfort followed by standby), the basic setpoint set via local control or received via the object will be discarded and replaced by the value which was originally parameterized in the ETS.

Adjusting the setpoints for standby mode, night mode and Dead band (comfort temperature for cooling):

Since the set-temperatures for the „standby“ and „night“ operating modes or the setpoints for the „cooling“ heating/cooling mode are derived from the basic set-temperature – in consideration of the increase, decrease or Dead band values that are parameterized in the ETS plug-in – these set-temperatures will shift linearly by the change of the basic setpoint value.

In addition, it is possible adjust set-temperatures exclusively via local control in the programming mode for „standby“ and „night“ other than parameterized in the ETS for the first control circuit. In this case, the originally parameterized decrease, increase temperatures or Dead band temperatures will be replaced by the new values resulting from the locally adjusted temperature setpoints. Independent of the „accept modification of the basic temperature setpoint value permanently“ parameter, the temperature setpoints for the standby or night mode or „cooling“ comfort mode (Dead band) will always be stored in the non-volatile EEPROM memory.



#### 4.4.2.2 Basic setpoint shifting

In addition to the setting of individual temperature setpoints via the ETS, the user is able to shift the basic setpoint within a settable range anytime via local control in programming mode or via the basic setpoint object.

During normal operation (no programming mode is active), the set-temperature for the activated operating mode of the first control circuit can be shown on the display by actuating one of the two display keys. In addition, the „setpoint shifting“ push button function can be adjusted (cf. „3.3 Rocker functions“) if the room temperature function is enabled. (["3.3 Rocker functions"](#)). An actuated key parameterized to function as such will activate – just like the display keys – the temperature display of the setpoint.

Pressing the right/left display key will shift the displayed set- temperature in 0.5 °C increments upwards/downwards. Analogous to the shifting via the display keys, a push button's function key parameterized to a setpoint shifting can decrease or increase the shifting value. The direction of the value adjustment is determined via the „command on pressing the push button“ parameter in the „push button function / general / [key designation]“ parameter branch.

A long key-press will continue the adjustment. An adjustment takes place every 0.5 seconds.

The hand symbol „“ on the display indicates that a basic setpoint shifting has been set. The adjusted temperature value is instantly accepted as the new setpoint.

It has to be considered that a shifting of the displayed set-temperature (temperature offset of the basic temperature) will directly affect the basic setpoint and as a result shift all other temperature setpoints. In case of two control circuits with separate setpoints, the set-temperatures of both circuits will be shifted.

Whether a basic setpoint shifting only affects the currently active operating mode or whether it influences all other set-temperatures of the remaining operating modes is determined by the „*accept modification of shift of basic setpoint value permanently*“ parameter in the „setpoint“ parameter branch.

Settings: „no“ (default):

The basic setpoint shifting carried out is in effect for only as long as the operating mode or heating/cooling mode has not changed or the basic setpoint is maintained. Otherwise the setpoint shifting will be reset to „0“.

Setting „yes“:

In general, the shifting of the basic setpoint carried out affects all operating modes. The shifting is maintained even after switching-over the operating mode or the heating/cooling mode or readjusting the basic setpoint.

The adjustable temperature range for a basic setpoint shifting is defined via the „upward adjustment of basic setpoint temperature“ or „downward adjustment of basic setpoint temperature“ parameters. It is possible to shift the current setpoint by a maximum of +/- 10 K. The stage offset is set to a non-adjustable 0.5 °C.

Notes on the basic setpoint shifting:

- Since the value for the basic setpoint shifting is stored exclusively in volatile memory (RAM), the shifting will get lost in case of a reset (e.g. bus voltage failure).
- A setpoint shifting does not affect the temperature setpoints for frost or heat protection!
- If the control is actively disabled, there will be no response to an actuation of the left or right display key or a „setpoint shifting“ function key.
- The basic setpoint shifting has no influence on the „basic setpoint“ object.

# Push button 2, 3, 5gang with room thermostat (RTR) and display flush-mounted

## 756627xx, 756637xx, 756657xx

Communication objects for the basic setpoint shifting:

The controller tracks the current setpoint shifting in the communication object 52 ("*current setpoint shifting*") via the controller with a 1-byte counter value (acc. to KNX DPT 6.010 – representation of positive and negative values in a 2's complement) This object is found in the „*room temperature regulator function / set point values*“ parameter branch. By connecting to this object the controller extensions are also able to display the current setpoint shifting.

As soon as there is an adjustment by one temperature increment in positive direction, the controller counts up the value by one digit. The counter value will be counted down by one digit, if there is a negative adjustment of the temperature.

Thus the possible range of values for the object is determined by the setpoint's adjustment options. A value of „0“ means that no setpoint shifting has been adjusted.

Example:

Initial situation:

The temperature increment for the setpoint shifting is set to 0.5 K.

Current set-temperature = 21.0°C / counter value in Object 52 = „0“ (no active setpoint shifting)

After the setpoint shifting:

- A setpoint shifting by one temperature increment in positive direction will count up the value in object 52 by one = „1“. Current set-temperature = 21.5°C.
  - Another setpoint shifting by one temperature increment in positive direction will count up the value in object 52 by one = „2“. Current set-temperature = 22.0°C.
  - A setpoint shifting by one temperature increment in negative direction will count down the value in object 52 by one = „1“. Current set-temperature = 21.5°C.
  - Another setpoint shifting by one temperature increment in negative direction will again count down the value in object 52 by one = „0“. Current set-temperature = 21.0°C.
  - Another setpoint shifting by one temperature increment in negative direction will again count down the value in object 52 by one = „-1“. Current set-temperature = 20.5°C.
- etc.

The maximum possible range of values for the „*current setpoint shifting*“ communication object depends on the „upward / downward adjustment of basic setpoint temperature“ parameter. A parameterization of  $\pm 10$  K at this point will have the value of the object move within the limits -20 to +20.

In addition, the setpoint shifting of the controller can be externally adjusted via the communication object 53 ("*preset setpoint shifting*"). This object can also be found in the „*room temperature regulator function / set point values*“ parameter branch and has the same data point type and range of values as the object 52 (see above). By connecting to the object 53 the controller extensions are also able to directly adjust the current setpoint shifting of the controller.

As soon as the controller receives a value, it will adjust the setpoint shifting correspondingly. Each value increment corresponds to the temperature increment of 0.5°C (cf. example above). Values that lie within the possible range can be directly jumped to.

The controller monitors the received value independently. As soon as the external preset value exceeds the limits of the adjustment options for the setpoint shifting in positive or negative direction, the controller will correct the received value and adjust the setpoint shifting to maximum. Depending on the direction of the shifting, the value feedback is set to the maximum value via the communication object 52 ("*current setpoint shifting*").

#### 4.4.3 Transmitting the set-temperature

The set-temperature, which is given by the active operating mode or has been subsequently adjusted, can be actively transmitted on the bus via the object 50, or in case of two control circuits with separate setpoints additionally via the „set temperature“ object 51.

The „*transmission at setpoint temperature modification by...*“ parameter in the „*room temperature regulator functions – set point values*“ parameter branch determines the temperature value by which the setpoint has to change in order to have the set-temperature value transmitted automatically via the object. Temperature value changes between 0.1 C and 25.5°C or 0.1 K and 25.5 K are possible. The setting „0“ at this point will deactivate the automatic transmission of the set temperature.

In addition, the setpoint can be transmitted periodically. The „cyclical transmission of setpoint temperature“ parameter determines the cycle time (1 to 255 minutes). The value „0“ (default) will deactivate the periodical transmission of the set-temperature.

It has to be pointed out that in case of a deactivated periodical transmission and a deactivated automatic transmission, no more set-temperature telegrams will be transmitted”.

Setting the „R“ flag on the „set temperature“ object makes it possible to read out the current setpoint. Following the return of bus voltage, new programming via the ETS or a replugging of the user module, the object value will be updated according to the current set-temperature value and actively transmitted on the bus.

#### 4.5 Room temperature measurement

The room temperature regulator periodically measures the actual-temperature and compares it with the given set-temperature. The control algorithm calculates the adjusted actuating variable from the difference between actual and set-temperature.

In order to ensure a fault-free and effective room temperature control, it is very important to determine the exact actual-temperature.

The push button with RTR and display features an integrated temperature sensor. Alternatively (e.g. if the push button has been installed in an unfavourable location or operates in difficult conditions, for example, in a moist atmosphere) or additionally (e.g. in large rooms or halls), a second KNX/EIB temperature sensor externally coupled via the bus may be used to determine the actual value in case of only one control circuit.

When using two control circuits, the actual-temperature of the second circuit is determined by the external sensor. The first control circuit can measure the actual-temperature only via the external sensor!

When choosing the installation location of the push button with RTR and display or the external sensor, the following points should be considered:

- The push button should not be used in multiple combinations, especially with flush-mounted dimmers.
- The sensors should not be installed in the vicinity of large electrical consumers (heat radiation).
- The push button should not be installed in the vicinity of heaters or cooling systems.
- The temperature sensor should not be exposed to direct sun.
- The installation of sensors on the inside of an outside wall might have a negative impact on the temperature measurement.
- Temperature sensors should be installed at least 30 cm away from doors or windows and at least 1.5 m above the floor.

#### 4.5.1 Temperature detection and determination of measured value

The temperature detection with one control circuit depends on the following parameterization. When using both control circuits, the actual-temperature of the second circuit is determined by the external sensor.

1 control circuit:

When using only one control circuit the „*temperature detection*“ parameter in the „*room temperature regulator function – room temperature measuring*“ parameter branch will determine which one of the sensors shall determine the actual-temperature. The following settings are possible:

- *“Internal sensor”*:

The temperature sensor integrated in the push button with RTR and display is activated. Thus, the actual-temperature is determined only locally on the device.

When parameterized as such, the control will start directly after a reset.

- *“External sensor”* (not with controller extension):

The actual-temperature is determined solely via the external temperature sensor. The internal sensor is deactivated. The external sensor must transmit the detected temperature value on the push button's 2-byte object 24 „*external temperature sensor*“ (DPT-ID 9.001). Alternatively or additionally, the push button can periodically request the current temperature value (set „R“ flag for the external sensor!).

The „*scanning time for external sensor...*“ parameter has to be set to a value > „0“. The measurement interval can be set from 1 minute to 255 minutes. When parameterized as such, the room temperature regulator will wait for a temperature value telegram from the external temperature sensor after a reset until the control starts and an actuating variable, if applicable, is output.

- *“Internal and external sensor”*:

With this setting the internal as well as the external temperature sensor is active. The external sensor must transmit the detected temperature value on the push button's 2-byte „*external temperature sensor*“ (DPT-ID 9.001) object 24. Alternatively or additionally, the push button can periodically request the current temperature value (set „R“ flag for the external sensor!). The „*scanning time for external sensor...*“ parameter has to be set to a value > „0“. The measurement interval can be set from 1 minute to 255 minutes. This parameterization will cause the room temperature regulator to wait for a temperature value telegram from the external temperature sensor after a reset until the control starts and an actuating variable, if applicable, is output.

The actual actual-temperature is made up from the two measured temperature values. The weighting of the temperature values is determined by the „*creating of measuring value internal against external*“ parameter. Depending on the different locations of the sensors or a possible non-uniform heat distribution inside the room, it is thus possible to adjust the actual-temperature measurement. Often, those temperature sensors that are subject to negative external influences (e.g., unfavourable location because of exposure to sun or heater or door / window directly next to it) are weighted less heavily.

Example:

The push button with RTR and display has been installed next to the entrance door (internal sensor). An additional external temperature sensor has been mounted on an inner wall in the middle of the room below the ceiling.

Internal sensor: 21.5°C (measuring range of internal sensor: 0 C ... + 40°C ±1%)

External sensor: 22.3°C

Determination of measured value: 30% to 70 %

Result:  $T_{\text{Result intern}} = T_{\text{intern}} \cdot 0.3 = 6.45^\circ\text{C}$ ,  $T_{\text{Result extern}} = T_{\text{extern}} \cdot 0.7 = 15.61^\circ\text{C} \rightarrow$

$T_{\text{Result actual}} = T_{\text{Result intern}} + T_{\text{Result extern}} = \underline{\underline{22.06^\circ\text{C}}}$

2 control circuits:

The first control circuit measures the actual-temperature exclusively via the internal sensor. The external sensor measures the actual-temperature of the second control circuit and must transmit the temperature value on the „*external temperature sensor*“ (DPT-ID 9.001) 2-byte object 24. Alternatively or additionally, the push button can periodically request the current temperature value (set „R“ flag for the external sensor!). The „*scanning time for external sensor...*“ parameter has to be set to a value > „0“. The measurement interval can be set from 1 minute to 255 minutes. This parameterization causes the room temperature regulator to wait for a temperature value telegram from the external temperature sensor after a reset until the control of the second circuit starts and an actuating variable, if applicable, is output.

#### 4.5.2 Calibrating the measured values

Some cases may require to calibrate the temperature measurements of the internal and external sensor. A calibration becomes necessary, if the temperature measured by the sensors stay permanently below or above the actual room temperature in the vicinity of the sensor. The actual room temperature should be determined by a reference measurement with a calibrated temperature measuring device.

The „*adjustment internal sensor...*“ or „*adjustment external sensor...*“ parameter in the „*room temperature regulator function –room temperature measuring*“ parameter branch allows to parameterize the positive temperature increase, factors 1...127) or negative (temperature decrease, factors – 128...-1) temperature adjustment in 0.1°C increments. Thus the calibration is adjusted only once and is the same for all operating modes.

Notes:

- The measured value has to be increased, if the value measured by the sensor lies below the actual room temperature. The measured value has to be decreased, if the value measured by the sensor lies above the actual room temperature.
- When determining the measured value between the internal and external sensor with only one control circuit, the calibrated value is used to calculate the actual value.

#### 4.5.3 Transmitting the actual-temperature

The determined actual-temperature of the first control circuit can be actively transmitted on the bus via the „*actual-temperature*“ object 23.

The „*transmission at room temperature modification by...*“ parameter in the „*room temperature regulator functions –room temperature measuring*“ parameter branch determines the temperature value by which the actual value has to change in order to have the actual-temperature value transmitted automatically via the object 23. Temperature value changes between 0.1 C and 25.5°C or 0.1 K and 25.5 K are possible.

The setting to „0“ at this point will deactivate the automatic transmission of the actual-temperature.

In addition, the actual value can be transmitted periodically. The „*cyclical transmission of room temperature*“ parameter determines the cycle time (1 to 255 minutes). The value „0“ (default) will deactivate the periodical transmission of the actual-temperature value.

Setting the „R“ flag on the „*actual-temperature*“ object makes it possible to read out the current actual value.

It has to be pointed out that with deactivated periodical transmission and deactivated automatic transmission, no more actual-temperature telegrams will be transmitted”.

Following the return of bus voltage, new programming via the ETS or a replugging of the user module, the object value will be updated according to the actual-temperature value and transmitted on the bus.

In case a temperature value telegram has not been received from the external sensor when using the external sensor with only one control circuit, only the value provided by the internal sensor will be transmitted. If only the external sensor is used, the value „0“ will be in the object after a reset. For this reason, the external temperature sensor should always transmit the current value after a reset.



#### 4.6 Disable functions of the room temperature regulator

##### 4.6.1 Disabling controller

Certain operation conditions may require the deactivation of the room temperature control. For example, the control can be switched-off during the dew point mode of a cooling system or during maintenance work on the heating or cooling system.

The „*switch-off controller (dew point mode)*“ parameter in the „*room temperature regulator functions*“ parameter branch enables the „*controller disable*“ object 40 when set to „*via object*“. In addition, the controller disable function can be permanently deactivated when set to „*no*“ (default).

In case a „1“ telegram is received via the enabled disable object, the room temperature control of both control circuits will be completely deactivated. In this case all actuating variables = „0“ and the „“ symbol lights up in the display (wait for 30 sec actuating variable update interval!). The controller, however, can be operated in this case.

The additional stage can be separately disabled when in two-stage heating or cooling mode. The „*additional stage inhibit object*“ parameter in the „*room temperature regulator functions*“ parameter branch will enable the „*disable additional stage*“ object 41 when set to „*yes*“. In addition, the disable function of the additional stage can be permanently deactivated when set to „*no*“ (default).

In case a „1“ telegram is received via the enabled disable object, the room temperature control is completely deactivated by the additional stage. The actuating variable of the additional stage is „0“ while the basic stage continues to operate.

In case both control circuits are used, the second control circuit can be separately disabled. If a „1“ telegram is received via the „*2<sup>nd</sup> disable control circuit*“ disable object 41, the room temperature control of the second control circuit will be deactivated, the actuating variable of this circuit will be „0“. In this case the first control circuit will continue to run.

A disable is always deleted after a reset (return of bus voltage, ETS programming operation).

##### 4.6.2 Disabling controller operation

It is possible to disable the local control of the room temperature regulator (all keys associated with the room temperature regulator). An active disable of the control will be indicated by the „“ symbol on the display. It has to be pointed out that this symbol is not exclusive and that it will also light up if the push button disable function is activated.

The „*operation of controller inhibitible*“ parameter in the „*room temperature functions*“ parameter branch can be used to determine whether the local control is never possible (setting: „*always disabled*“ or whether it can be disabled via the „*controller operation disable*“ object 39 (setting: „*via object*“).

The „*always disabled*“ setting does not allow to parameterize the operating mode switch-over among the key or rocker functions. In addition, the two display keys for the shifting of the basic setpoint have no function with this setting.

When set to „*via object*“ the local control will be deactivated, if a „1“ telegram is received on the object. Hence, the local control will be activated again after receiving a „0“ telegram. Actuating a key assigned to an operating mode switch-over or the display keys for the shifting of the basic setpoint will show no response during an active disable.

If the control is activated, it will neither influence the operation of the controller via the objects nor the room temperature control itself, i.e. the control algorithm is running and creating actuating variables and status reports.

A disable of the control is always deleted following a reset (return of bus voltage, ETS programming operation).

# Push button 2, 3, 5gang with room thermostat (RTR) and display flush-mounted 756627xx, 756637xx, 756657xx

## 4.7 Room temperature timer

The room temperature timer can differentiate up to 28 different switching programs and allows to switch-over the room temperature regulator's operating mode depending on the time and day of week. The room temperature timer must be enabled via the „room temperature timer = on“ parameter in the „room temperature regulator function – room temperature timer“ parameter branch. Alternatively, the function is permanently disabled via the „room temperature timer = off“ setting (default). In case the push button functions as a controller extension, a room temperature timer cannot be projected.

The switching programs will be parameterized in the ETS plug-in and chronologically processed, if the timer function is enabled. The „room temperature timer“ menu item in the „timer editors“ menu will open the „room temperature timer switching times“ editor:

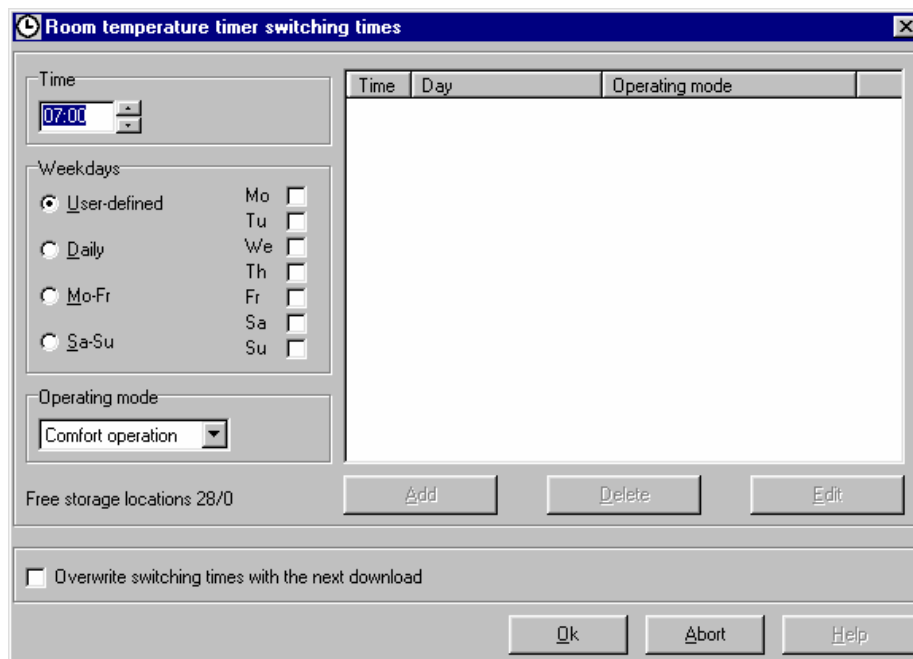

In the left part of the window the time is shown exact to the minute. In addition, the weekdays can be defined on which the switching time is to be executed. Available are the selections: „User-defined“ (Mo, Tu, ..., Su), „Daily“ (Mo – Su), „weekdays“ (Mo – Fr) or „weekend“ (Sa – Su).

Each switching program allocates a memory location in the push button RTR. Only one memory location is required for the „weekdays“ or „weekend“ settings. When set to „User-defined“, however, sometimes up to 5 different switching programs are created depending on the parameterized days. The „free storage locations“ info parameter in the editor indicates how many memory locations are available (number before the slash) or how many memory locations can be allocated for the selected setting (number behind the slash).

In addition, the operating mode that is to be activated when calling a switching programme has to be selected. The „comfort mode“, „standby mode“ or „night mode“ modes can be selected.

It has to be pointed out that an operating mode set via the room temperature timer is on equal terms with a local control on the push button or via the switch-over objects (4 x 1-bit or 1-byte KONNEX switching object) and can be changed accordingly.

The switching times are projected by the minute. With an activated timer, checking the switching times takes place via the time control of the push button by the minute.

The internal clock of the push button should be set at least once an hour by an external time signal via the bus in order to keep the deviation as small as possible.

In rare cases it is possible that switching times will not be executed (skipped switching minute), if there are larger time differences between the tracked time in the push button and the one received via the bus. For this reason, the bus synchronization should not take place at predetermined switching times!



# Push button 2, 3, 5gang with room thermostat (RTR) and display flush-mounted

## 756627xx, 756637xx, 756657xx

Once the switching programme (switching time, weekdays, operating mode) has been selected, the programme will be accepted into the programme list by clicking the „Add“ button. This list is displayed on the right side of the editor window:

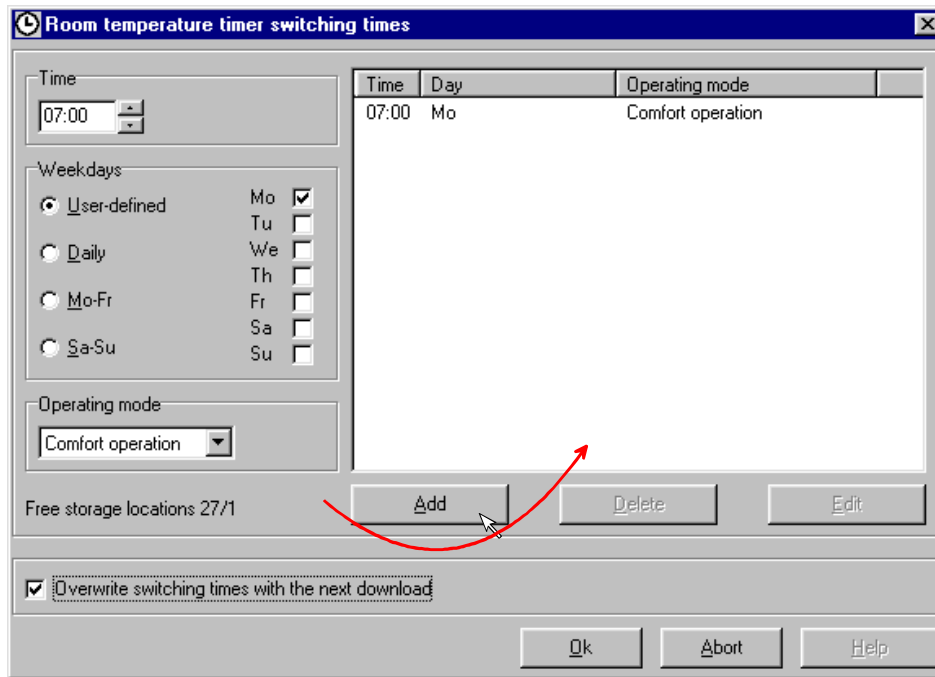

This way it is possible to pre-program up to 28 switching programmes. A programme created in the right part of the window may be edited by highlighting it and clicking the „Edit“ button. Highlighting the programme and clicking the „Delete“ button will delete the programme and remove it from the list. Clicking the „OK“ button will accept the settings into the projection of the push button.

The temperature timer's switching programmes will be downloaded into the device when programming the complete application or partially programming the parameters, if the „*overwrite switching times with the next download*“ check box in the editor window has been selected.

In addition to setting the timer programmes in the ETS plug-in, it is possible to edit the switching times, the weekdays and the operating modes even after a local programming operation on the push button in programming mode. For this, the „Complete operation“ via the display keys must be enabled (depending on the parameter).

In order to avoid overwriting the locally changed data by an ETS programming operation, it is possible to deselect the „*overwrite switching times with the next download*“ check box in the editor window.

Editing the switching programmes in programming mode is not possible, if the room temperature timer has been deactivated (cf. next page).

# Push button 2, 3, 5gang with room thermostat (RTR) and display flush-mounted

## 756627xx, 756637xx, 756657xx

The room temperature timer may be activated or deactivated via local control in programming mode, if enabled, (cf. "1.4 Programming mode / local control") and/or via a push button control (key function). The „“ symbol will light up on the display if the function is activated. The switching programmes will be chronologically processed according to the parameterized switching times.

Info: In case the room temperature is activated at exactly the same time as a parameterized switching time, the concerned switching programme will be executed later.

Once switching programmes have been programmed into the device, the room temperature timer is activated directly after the initialisation phase and the programmes are being processed. For this, a received valid time and weekday is required. If no programmes are stored in the device and the function itself enabled, the symbol will light up after a reset but no switching programmes will be executed.

A switch-over into another operating mode triggered by the room temperature timer can also momentarily be suppressed via a separate disable object. In order to enable the disable function, the „*lock room temperature timer via object*“ parameter in the „*room temperature regulator function – room temperature timer*“ parameter branch must be set to „yes“. In this case the „*disabling room-temperature-timer*“ disable object 55 will be enabled. The polarity can be parameterized.

If the room temperature timer is disabled via the bus, the „“ symbol will disappear.

During an active disable function, the operating mode will not be switched-over by the room temperature timer. In case the room temperature timer is enabled again at the exact time as a parameterized switching time, the concerned switching programme will be executed later.

Activations or deactivations of the room temperature timer during the disable phase will be memorized and tracked once the disable has ended.

Important notes on the room temperature timer:

- The room temperature timer will be automatically deactivated, if the frost/heat protection operating mode is activated! This will prevent an unwanted operating mode switch-over, for example, during a longer absence that accidentally heats up or cools down the room.  
A switch-over into the frost/heat protection can take place directly on the device (e.g. in programming mode or via push button control) or via the switch-over objects (4 x 1-bit or KONNEX). Activating the frost/heat protection via the window status or the frost protection automatic will not deactivate the room temperature timer!  
Even when setting the operating mode via the KONNEX forced-object the room temperature timer will be deactivated until enabled (value „0“ / Auto).  
A room temperature timer automatically deactivated may be activated again anytime via push button control (room temperature timer control). An automatic re-activation will take place as soon as the frost/heat protection mode is terminated.  
Even a regular operating mode switch-over (comfort, standby, night) will re-activate the room temperature timer!
- The internal clock of the push button should be set at least once an hour by an external time signal via the bus in order to keep the deviation as small as possible. If the internal clock has not been updated at least once a day via the bus. (update check at 4:00 at night), the „--:--“ symbol will appear on the push button's display, if the time of day is shown on the display (depends on the parameter). In this case, however, the internal clock continues to run with the expected deviation while the parameterized switching programmes of the room temperature timer will continue to be processed.
- The weekday information is provided by the time signal. The room temperature timer will process the programmed switching programmes only after receiving a valid weekday. In normal operation, the weekdays are displayed on the push button as numerical characters (1...7).

#### 4.8 Temperature alarm

The push button with RTR and display is able to monitor two temperature values, if desired. When exceeding or falling short of these parameterizable values, switching telegrams, e.g. an alarm value, can be transmitted on the bus.

The temperature monitoring can be activated in the „*room temperature regulator function / room temperature measuring*“ parameter branch via the „*send temperature alarm via object = yes*“.

Alternatively, the „no“ setting (default) deactivates the temperature monitoring.

If the function is activated, the „*temperature alarm 1*“ object 65 for the lower temperature value and the „*temperature alarm 2*“ object 66 for the upper temperature value will become visible.

If the lower temperature value ( $T_{\text{actual}} < T_{\text{lower value}}$ ) is exceeded, a „1“ telegram will be transmitted on the bus via the „*temperature alarm 1*“ object. As soon as the room temperature reaches or exceeds the lower limit ( $T_{\text{actual}} \geq T_{\text{lower value}}$ ), a „0“ telegram will be transmitted on the bus via the „*temperature alarm 1*“ object. If the upper temperature value ( $T_{\text{actual}} > T_{\text{upper value}}$ ) is exceeded, a „1“ telegram will be transmitted on the bus via the „*temperature alarm 2*“ object. As soon as the room temperature reaches or exceeds the upper limit ( $T_{\text{actual}} \leq T_{\text{upper value}}$ ), a „0“ telegram will be transmitted on the bus via the „*temperature alarm 2*“ object.

Every minute the temperature values are compared with the determined actual-temperature (room temperature). Hence, a temperature alarm telegram is transmitted no more than once a minute. In addition, the telegrams will be transmitted only if the switching value has changed.

It has to be pointed out that the temperature monitoring requires a valid actual-temperature value in order to operate. Before using an external temperature sensor a valid telegram must have been received.

The lower temperature value must be below the upper limit. In case the values are parameterized differently than described, the ETS plug-in will report an error and request to change the data.

Disabling the room temperature regulator (dew point operation) will not affect the temperature alarm.

#### 4.9 Valve protection

A valve protection may be carried out periodically in order to prevent the addressed control valves of the heater or cooling system to become calcified or stuck. The „*valve protection*“ parameter in the „*room temperature regulator function*“ parameter branch will activate the valve protection by setting it to „yes“.

This type of protection is generally started not only for non-active actuating variable outputs, i.e. for outputs which have not requested any heating or cooling energy over the past 24 hours.

By taking into account the parameterization, the controller will periodically set the actuating variable to the maximum value once a day for a duration of approx. 5 minutes.

Actuating variable output not inverted: 1-bit actuating variable: „1“, 1-byte actuating variable: „255“,  
Actuating variable inverted: 1-bit actuating variable: „0“, 1-byte actuating variable: „0“.

Thus even long closed valves will be shortly opened on a regular basis.

The valve protection is controlled by the internal clock and activated for the relevant actuating variables at 8:00 o'clock. In case the clock has not been set following a reset, the valve protection will be carried out approx. 32 hours after the reset at the earliest.

## 5. Controller extension function

### 5.1 General

Alternatively to the function as a room temperature regulator, the extension mode can be activated. This way the push button with RTR and display can address other push buttons that are parameterized as controllers. For example, it is possible to fully control the controller by changing the operating mode or the presence function or the setpoint shifting. In addition, the controller extension can indicate the status of the room temperature regulator on the display and the status-LED. So, the set or room temperature and the setpoint shifting on the extension can be displayed as well as the current operating mode and the message indicating whether the system is heating or cooling.

The controller extension function is switched-on via the „*controller extension function*“ parameter in the „*push button xgang*“ parameter branch. If the room temperature regulator function is activated, it will not be possible to parameterize the extension.

Several controller extensions may affect a main controller.

### 5.2 Push button functions of the controller extension

While the controller extension functions are activated, the push button's function keys can be parameterized in the „*push button function / general / [key-/rocker designation]*“ to „*controller extension*“ (cf. „3.3 Rocker functions“) parameter branch. In this case the controller operating functions will be activated. The controller extension may be set for touch control as well as for rocker control.

The „*function*“ parameter defines the control function, which is assigned to the key or the rocker. The following chapters describe the settable controller extension functions.

Depending on the controller extension the status-LED's for touch control can be parameterized (cf. [following chapter](#)). With rocker control the two status-LED's of the rocker (left and right) can be parameterized and controlled irrespectively of the rocker function. The „*function of left / right status-LED*“ parameter in the „*push button function / general / [key designation] / state of rocker x*“ parameter branch determines whether the LED is permanently switched on or off or whether it is controlled via the „*rocker X [status left / right]*“ object. In the latter case the polarity of the status objects is definable.

#### 5.2.1 "Normal operating mode switch-over" controller extension function

If these extension functions are set, the controller extension will be able to switch-over the operating mode of the room temperature regulator. This requires that the operating mode switch-over on the controller takes place via a communication object that conforms to KONNEX (1-byte switch-over – cf. [4.1.1 Operating mode switch-over](#)). In this case the „*operating mode switch-over controller extension*“ object in the „*controller extension function*“ parameter branch must be connected with the main controller. In order to transmit a change of the operating mode on the main controller to the extensions as well, the „T“ flag has to be set on the main controller's object!

The „*operating mode on pressing a push button*“ parameter in the parameter branch of the function key defines the operating mode which will be transmitted on the bus when actuating a key and which should be activated on the controller. With touch control either one of the „*comfort*“, „*standby*“, „*night*“ and „*frost/heat protection*“ operating modes can be parameterized.

With rocker control the modes are basically changed one after another depending on the key pressed left or right.

The function of the status-LED is parameterizable. Touch control allows to select the „*display push button function active*“ and „*display push button function inactive*“ settings in addition to the „*always off*“, „*always on*“ and „*operation indication*“ default settings. Thus the status-LED can signal whether an operating mode recalled by the key is active or not.

Alternatively, the status-LED can be switched via a separate communication object. The polarity of the status object in the „*push button function / general / [key designation] /state of rocker x*“ parameter branch is parameterizable.

In order for the LED status indication for the key function to work, the „*controller status indication of controller extension*“ object in the „*controller extension function*“ parameter branch must be connected to the main controller!

### 5.2.2 "Forced operating mode switch-over" controller extension function

If these extension functions are set, the controller extension will be able to switch-over the operating mode of the room temperature regulator via forced-control. This requires that the operating mode switch-over on the controller takes place via a forced communication object that conforms to KONNEX (1-byte switch-over – cf. 4.1.1 Operating mode switch-over). In this case the „*forced object operating mode controller extension*“ object in the „controller extension function“ parameter branch must be connected to the main controller. In order to transmit a change of the forced operating mode on the main controller to the extensions as well, the „T“ flag has to be set on the main controller’s object!

The „operating mode *on pressing a push button* „ parameter in the parameter branch of the function key defines the operating mode which will be transmitted on the bus when actuating a key and which should be activated on the controller via forced control. With touch control either one of the „comfort“, „standby“, „night“ and „frost/heat protection“ operating modes can be parameterized. The „auto“ setting will deactivate the forced setting.

With rocker control the modes are basically changed one after another depending on the key pressed left or right.

The function of the status-LED is parameterizable. Touch control allows to select the „display key function active“ and „display key function inactive“ settings in addition to the „always off“, „always on“ and „operation indication“ default settings. Thus the status-LED can signal whether an operating mode called by the key is active or not. Only the „auto“ mode cannot be indicated by a status-LED. The LED display can also not distinguish whether the operating mode has been set via a forced object or via the ‘normal’ operating switch-over’.

Alternatively, the status-LED can be switched via a separate communication object. The polarity of the status object in the „push button function / general / [key designation] / state of rocker x“ parameter branch is parameterizable.

In order for the LED status indication for the key function to work, the „controller status indication of controller extension „ object in the „controller extension function“ parameter branch must be connected to the main controller!

### 5.2.3 “Presence button” controller extension function

This extension function causes the transmission of a presence telegram when pressing a key and thus the activation of the presence mode on the controller (cf. [4.1.2 Notes on the operating modes – presence function/comfort mode extension](#)). This requires that the presence function is activated on the controller (“*type of presence detection = presence button*”). In this case the „*presence object controller extension*“ object in the „controller extension function“ parameter branch must be connected to the „*presence object*“ object of the main controller.

When actuating a function key, which is parameterized to this function, the presence function will be activated or deactivated. Actuating the rocker will also always result in a switch-over of the presence status regardless whether the left or right key was actuated.

The function of the status-LED is parameterizable. Touch control allows to select the „display key function active“ and „display key function inactive“ settings in addition to the „always off“, „always on“ and „operation indication“ default settings. Thus the status-LED can signal whether an operating mode called by the key is active or not.

Alternatively, the status-LED can be switched via a separate communication object. The polarity of the status object in the „push button function / general / [key designation] / state of rocker x „ parameter branch is parameterizable.

In order for the LED status indication for the key function to work, the „*presence object controller extension*“ object in the „controller extension function“ parameter branch must be connected to the main controller!



5.2.4 "Setpoint shifting" controller extension function

This extension function allows to shift the basic setpoint for the temperature on the room temperature regulator via a function key. The control on the extension is the same as a control on the main controller (cf. „4.4.2.2 Basic setpoint shifting“).

A function key parameterized for a setpoint shifting will decrease or increase the value of the setpoint shifting when pressing a key. The direction of the value adjustment is set via the „command on pressing the push button“ parameter in the „push button function / general / [key designation]“ parameter branch.

A long key-press will continue the adjustment. An adjustment takes place every 0.5 seconds.

The function of the status-LED is parameterizable. With touch control the „always off“, „always on“ and „operation indication“ settings can be selected. Alternatively, the status-LED can be switched via a separate communication object. The polarity of the status object in the „push button function / general / [key designation] /state of push button“ parameter branch is parameterizable.

Communication objects for the basic setpoint shifting:

In order to be able to use the setpoint shifting on the extension, the communication objects in the „controller extension function“ parameter branch must be connected to the objects of the controller or other extensions as follows:

Controller extension objects		Controller objects
“Current setpoint shifting controller extension” object 52	→	“Current setpoint shifting” object 52
“Preset setpoint shifting controller extension” object 53	→	“Preset setpoint shifting” object 53

The setpoint shifting currently adjusted on the controller is transmitted to the extensions. For this the controller updates the shifting in the „current setpoint shifting“ communication object 52 with a 1-byte counter value (cf. „4.4.2.2 Basic setpoint shifting“). By connecting to this object the controller extensions are able to determine the position of the setpoint shifting and to display the current setpoint shifting.

In addition, the controller’s setpoint shifting can be externally adjusted via the communication object 53 ("preset setpoint shifting"). This object has the same data point types and range of values as the object 52 (see above). By connecting to the object 53 the controller extensions are able to directly adjust the current setpoint shifting of the controller.

Starting from the current setpoint shifting (object 52), each key-press on an extension will adjust the setpoint in the corresponding direction by one counter value step. Each time the setpoint is adjusted a new shifting is transmitted to the room temperature regulator via the output object of the controller extension (object 53). The controller itself checks the received value for the minimum and maximum limits and adjusts the new setpoint shifting and accepts the new counter value into the output object (object 52).





Due to the standard data point type used as the output and input object of the controller extension and the weighting of the individual stage by the controller itself, each extension is able to determine whether a shifting took place, in which direction it took place and by how many steps the setpoint was shifted. This requires that the communication objects are connected on all controller extensions and the controller. The information for the step value as feedback from the controller enables the extension to continue the adjustment anytime at the right point. The extensions may also respond to a reset of the setpoint shifting by the controller and correctly display the current adjustment.

### 5.3 Display functions of the controller extension



The controller extension can display the status of the room temperature regulator. So, the set or room temperature and the setpoint shifting on the extension can be displayed as well as the current operating mode and the message whether the system is heating or cooling.

Certain communication objects must be connected to the main controller for the controller extension to display this information. The following shows the individual display information and the corresponding objects.

#### Display of the operating mode:

The extension can display the operating mode currently set on the controller. Just like on the controller itself the mode is indicated by the „ „ (comfort), „ „ (standby), „ „ (night) and „ „ (frost/heat protection) symbols.

This display information is provided by the „*controller status*“ communication object 36 that absolutely needs to be connected to the „*controller status*“ object of the main controller (1-byte!). It is not possible to use the display information to distinguish whether the operating mode has been set via a forced object or via the ‘normal’ operating switch-over in case of a KOONEX switch-over.

In addition, a comfort mode extension of the controller is not indicated by the „ „ or „ „ symbols. In this case only the comfort mode symbol is displayed.

The operating mode may also be switched-over via the push button functions of a controller extension (cf. „[5.2 Push button functions of the controller extension](#)“). A switch-over via the programming menu is not possible on the extension.

#### Display of a setpoint shifting:

The extension can indicate whether a basic setpoint shifting has been adjusted on the controller. If a basic setpoint shifting is active, the extensions will show the „ „ hand symbol on the display. This requires that the „*current setpoint shifting controller extension*“ communication object 52 is connected to the „*current setpoint shifting*“ object 52 of the main controller.

A basic setpoint shifting may also be set via the push button functions of a controller extension (cf. „[5.2 Setpoint shifting’ controller extension function](#)“).

#### Display of set-temperature:

The controller extension can display the set temperature of the room temperature regulator. If this display is used, the „*set temperature controller extension*“ communication object 50 must be linked to the „*set temperature*“ object 50 of the main controller. In addition, the display of the extension must be configured for the display of the setpoint. This requires the „*display of*“ parameter in the „*Display*“ parameter branch to be parameterized for a setting that allows the display of the set-temperature.

#### Display of room temperature and room temperature measurement:

The display of the controller extension may also indicate the currently determined room temperature (actual-temperature). This requires the display of the extension to be configured for the display of room temperature. The „*display of*“ parameter in the „*Display*“ parameter branch must be parameterized to a setting that allows the display of the room temperature.

The extension measures the room temperature independently in the same way as the controller. Thus the controller extension can determine the actual-temperature via its own internal sensor or additionally via another external sensor. It is also possible to evaluate and transmit a temperature alarm. The parameters required for temperature measurement can be found in the „*room temperature measuring*“ parameter branch (cf. „[4.5 Room temperature measurement](#)“ and following).



Normally, the room temperature determined on the extension will also be transmitted to the main controller (as an external sensor) in order to be integrated there into the room temperature regulator. If such integration takes place, the „*actual-temperature*“ communication object 23 of the controller extension must be connected to the „*external temperature sensor*“ object 24. The external temperature sensor has to be enabled on the main controller.



# Push button 2, 3, 5gang with room thermostat (RTR) and display flush-mounted

## 756627xx, 756637xx, 756657xx

Display of the „heating“ and „cooling“ messages:













If actuating variables are greater than „0“ the main controller will show on the display that heating and cooling energy is requested. This is indicated by the „“ symbol for heating or by the „“ symbol for cooling.

A controller extension may also show this information on the display. In heating mode or mixed-mode the „*indication heating*“ communication object 37 must be connected to the „*indication heating*“ object 37 of the main controller. In cooling mode or mixed-mode the „*indication cooling*“ communication object 38 must be connected to the „*message cooling*“ object 38 of the main controller.

A simultaneous heating or cooling can be displayed on the controller extension. Therefore, the objects of the extension may not be active at the same time „1“!

### 5.4 Overview of the communication objects

The following shows and explains all communication objects of the controller extension in the „*controller extension function*“ parameter branch...

Object	Summarized description
 23 Actual-temperature	For the transmission of the room temperature measured on the main controller.
 24 External temperature sensor	For the connection of an additional external temperature sensor on the extension.
 28 Operating mode switch-over controller extension:	For the switch-over and transmission of the operating mode to the main controller.
 32 Forced-object operating mode controller extension	For the switch-over and transmission of the forced-operating mode to the main controller.
 33 Presence object controller extension	For the switch-over and transmission of the presence status to the main controller. Also for activating the status-LED of a presence button.
 36 Controller status indication of controller extension	For the display of different symbols. Also for addressing the status-LED of a function key to switch-over the operating mode.
 37 Message heating controller extension	For the display of the heating symbol.
 38 Message cooling controller extension	For the display of the cooling symbol.
 50 Set temperature controller extension	For showing the set-temperature of the main controller on the display of the extension.
 52 Current setpoint shifting controller extension	For receiving the counter value to adjust the setpoint of the main controller.
 53 Setting setpoint shifting controller extension	For setting a new counter value to adjust the setpoint for the main controller.
 65 Temperature alarm 1	For transmitting a temperature alarm on the bus.
 66 Temperature alarm 2	For transmitting a temperature alarm on the bus.

5.5 Behaviour of the controller extension after a reset

The different display and control functions of the controller extension are controlled via different communication objects as described in the previous chapters. A main controller must transmit the current status to the extensions, i.e. updating the communication objects so that after a programming operation or after the return of bus voltage all status information is available for the initialisation of the extension. This takes place automatically during the initialisation of the main controller.

For this reason all extensions should be put into operation first. Only then the main controller should be connected and programmed.

For larger KNX/EIB installations where the extensions are sometimes distributed over several lines, the remaining lines should also be initialized after a reset of one line.

Alternatively, the extensions may actively request the current object values from the bus during an initialization. The „State“ flag in the parameter branch of the object can be set to „on“ for the communication objects of the controller extension. In this case the extension will separately request the object values via a value-read telegram (ValueRead) during the initialization. The main controller responds to this read request via a value response thus updating the object of the extension in the process. It is important to set the „Read“ flag on the corresponding objects of the main controller!

If several extensions are used, the status request should only be activated on one extension. The remaining controller extensions will be updated by a response of the main controller as long as they are connected by the same group address.

**6. Scene function**

6.1 Scene definition

The push button with RTR and display features, similar to a light-scene push button, a scene function. With this function it is possible to store up to 8 different scenarios in the push button. Each scene is able to address up to 8 bus outputs (scene objects). It is possible to project switching, value or shutter position commands.

The scene function can basically be enabled in the „push button RTR“ parameter branch via the „scene function“ parameter. With disabled functions (default) the parameters and the objects of the scene functions are hidden.

Depending on the recalled scene the scene commands are transmitted on the bus via the scene outputs. The scene command will be separately defined for each output in the „scene function – scene X“ (X = 1 to 8) parameter branch.

In the ETS plug-in it is possible to parameterize the data type for each scene object in the „scene function“ parameter branch. Possible types and the available commands are...

Data type	Scene command
Switching (1-bit)	ON ("1") Off ("0")
Value (1-byte)	0...255 alternatively * 0...100 %
Shutter position (1-byte)	0...100 % Position „0“ = top

\*: The „Data type“ parameter in the „scene function“ parameter branch determines whether dimensionless (0...255) or percentage values (0...100 %) are to be provided.

It is possible to transmit up to 8 scene commands per scene on the bus via the output objects. It is possible to parameterize for each scene output whether a command shall be transmitted at all for a scene recall. The „*transmit output signal= yes*“ parameter setting in the „*scene functions – scene X*“ (X = 1 to 8) parameter branch enables the scene command. Consequently, scene commands for the relevant output will be suppressed by the „*no*“ setting.

The scene commands are stored in the non-volatile memory of the push button so that they do not get lost in case of a bus voltage failure.

## 6.2 Scene recall / scene memory

A scene may be recalled via...

- the scene extension object (object 64):  
A scene number received via the scene extension object recalls an internally stored scene. This kind of recall is frequently used by external bus components such as, for example, push buttons, display touch pads or complex scene controls.
- a local key function on the push button:  
In addition, a stored scene can be recalled locally on the push button via key actuation. If the key function is parameterized to „light-scene extension / recall“ and if the key is supposed to recall an internal scene ("*internal scene request*"), the scenes stored in the push button with RTR and display may be recalled via a short key-press (< 1 sec). In doing so, the corresponding scene number (1 to 8) must be selected in the ETS plug-in (cf. „3. Push button functions“).  
The extension object will be required only, if there is an additional activation via external bus components.

It is possible to change the scenes stored in the push button with RTR and display even after an ETS programming. A scene can be stored via...

- the scene extension object (object 64):  
A memory telegram is received via the extension object. According to the scene number the push button's scene control requests the current values of the scene objects from the actuators via the bus and stores them in non-volatile memory.
- a local key function on the push button:  
A key parameterized to „*internal scene request*“ with enabled memory function allows to store an internal scene acc. to the parameterized scene number via a long key-press > 5 sec. The scene control of the push button with RTR and display requests the current values of the scene objects from the actuators via the bus and stores them in non-volatile memory.

A new saving operation will replace the scene commands with new values for the relevant scene that were originally projected via the ETS.

No new command will be stored, if the push button with RTR and display receives no feedback to a read request. Non-transmitting scene objects of a scene cannot be changed.

It is possible to store switching commands, value commands or shutter positions anew.

In order to allow the actuators in the bus to respond to the push button's read request, the read-flag ("R" flag) has to be set on the relevant actuator objects.

In order to avoid communication problems when recalling or storing scenes, the communication flags of the scene objects should not be changed on the push button RTR.

## 7. Messages during a programming operation

Once the push button with RTR and display has been parameterized with the help of the ETS plug-in, it is possible to program in the starting-up environment of the ETS.

The following messages might pop up during a programming operation:

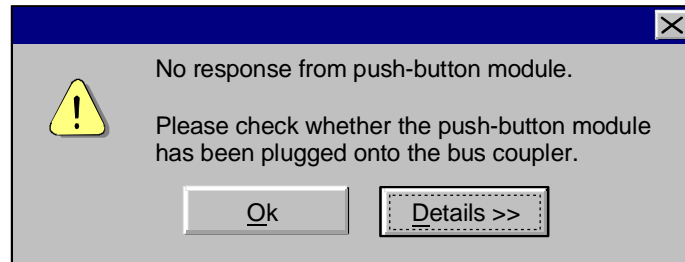

**Appears:** When trying to load the application data into the device.

**Reason:** There is no push button with RTR and display plugged onto the bus coupler.

**Remedy:** Plugging the push button with RTR and display onto the bus coupler. Attention must be paid to the accurate physical address of the bus coupler.

**Note:** The physical address of the device can be programmed even if the push button is not plugged on. The push button must be plugged on during the partial programming of application data.

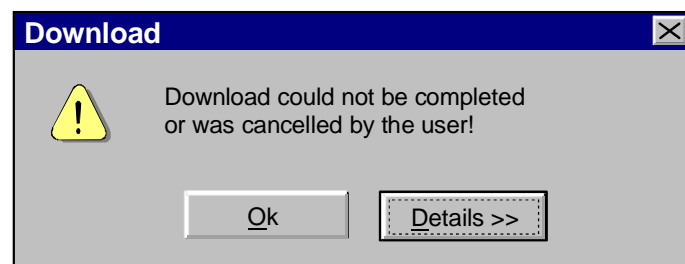

**Appears:** When trying to load the application data into the device.

**Reason:** The programming operation was aborted by clicking on the „cancel“ button or there is a communication error.

**Remedy:** Starting a new programming operation.

**Note:** During a programming operation, especially when programming the firmware, larger volumes of data are being transmitted to the device via the bus. The intelligent programming algorithm of the push button with RTR and display is able to recognize communication errors itself and to transmit the faulty data anew. In rare cases, however, it is not possible to prevent errors even by repeating the data transmission. In these cases, replacing the data interface, the PC or the serial data line to the data interface may remedy the problem. Preferably, one should program in the ETS 3 via USB.

It is possible to specify the number of download attempts in case of failure in the ETS plug-in in the „setting - options“ menu on the „hardware“ tab. The default setting includes 3 attempts and should be changed only in exceptional cases.

It has to be pointed out that an update of the firmware is necessary only in very exceptional cases!

**Push button 2, 3, 5gang with room thermostat (RTR) and display flush-mounted**  
**756627xx, 756637xx, 756657xx**

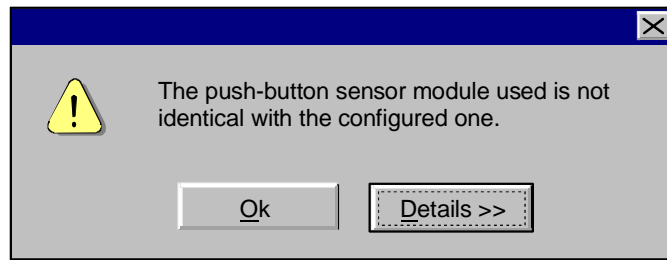

- Appears:** When trying to load the application data into the device.  
**Reason:** A different push button with RTR and display model has been plugged onto the bus coupler than the projected one (e.g. 5 rocker sensor instead of 3 rocker sensor).  
**Remedy:** Plugging on the proper model.

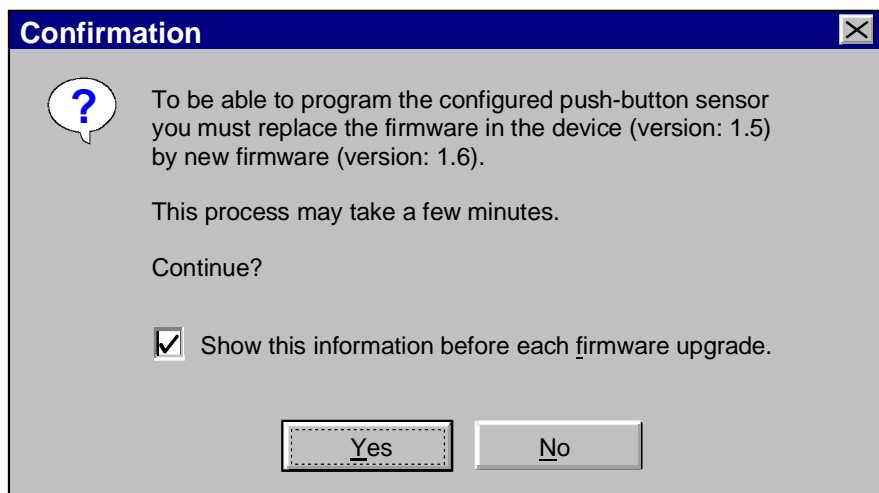

- Appears:** When trying to load the application data into the device.  
**Reason:** A push button with RTR and display that has an older firmware version (e.g. V 1.5) installed is programmed with a new push button with RTR and display software version (e.g. V 1.6).  
**Remedy:** This message does not represent an error. By clicking the „yes“ button the appropriate firmware will be automatically loaded into the device. „No“ will not program the old device since the default parameter and functions are not downwardly compatible.  
**Note:** By deselecting the „ show this information before each firmware upgrade“ checkbox, this message will not be shown again even when programming other older push buttons. The checkbox can be reactivated in the push button's ETS plug-in in the „setting - options“ menu on the „hardware“ tab.

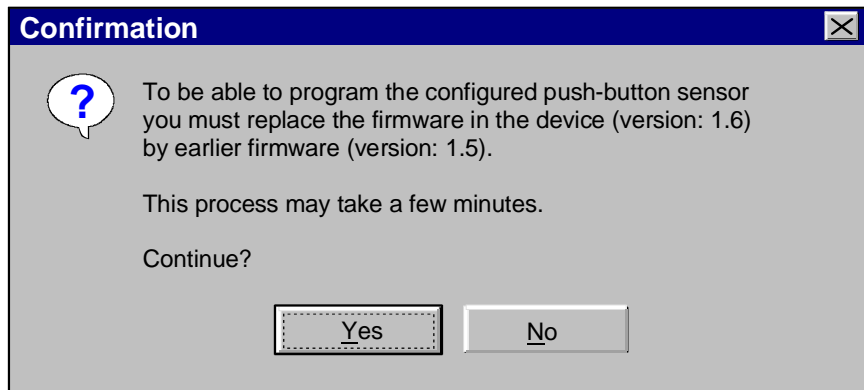

- Appears:** When trying to load the application data into the device.
- Reason:** A push button with RTR and display shall be programmed with a new firmware (e.g. V 1.6). In this case the existing version is newer than the one specified by the push button with RTR and display software in use.
- Remedy:** This message does not represent an error. By clicking the „yes“ button, the newer firmware installed in the device will be replaced by the older firmware version specified in the ETS plug-in. „No“ will not program the newer device since the default parameter and functions of the old software are not upwardly compatible. In this case a current push button with RTR and display software version should be installed.  
Depending on the resulting changes it might be necessary to project a new device in the ETS.

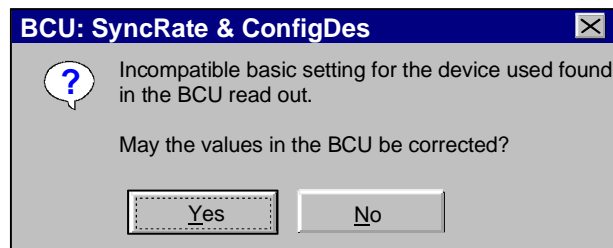

- Appears:** When trying to load the application data into the device.
- Reason:** The push button with RTR and display to be programmed is plugged onto a bus coupler, which doesn't fit to the projected push button. This is probably a bus coupler that had been used otherwise or a new device, which has not yet been used for the existing push button with RTR and display projection.
- Remedy:** This message does not represent an error. By clicking the „yes“ button the data will be overwritten in the BCU. If „no“ is selected the newer device is not programmed as the data in the BCU does not fit into the projection of the push button.

**Push button 2, 3, 5gang with room thermostat (RTR) and display flush-mounted**  
**756627xx, 756637xx, 756657xx**

Parameters		
Description:	Values:	Remarks:
 Push button xgang		
Push button function	Disabled <b>Enabled</b>	The parameter determines whether the push button function is switched-on or switched-off.
Room temperature regulator function	Disabled <b>Enabled</b>	The parameter determines whether the room temperature regulator function is switched-on or switched-off.
Controller extension function	<b>Disabled</b> Enabled	The parameter determines whether the controller extension function is switched-on or switched-off. Only if room temperature regulator function is switched-off!
Scene function	Disabled <b>Enabled</b>	The parameter determines whether the scene function is switched-on or switched-off.
Alarm function after pulling off the application module	<b>Disabled</b> Enabled	When unplugging the push button with RTR and display from the flush-mounted bus coupler, an alarm message may be transmitted on the bus. The parameter determines whether the alarm function is enabled or disabled.
Data format	<b>Switching telegram, 1-bit</b> Value telegram, 1-byte	Determines the data format of the alarm message.
Telegram after removal	OFF telegram <b>ON telegram</b>	Determines the value of the switching telegram that is transmitted with an alarm message. Only for data format = „switching telegram, 1-bit“.
Value after unplugging	0 to 255, <b>255</b> (when „reset value = no“) 1 to 255, 255 (when „reset value = yes“)	Determines the value of the value telegram that is transmitted with an alarm message. Only for data format = „value telegram, 1-bit“.
Reset value	<b>NO</b> YES	Determines whether the alarm value is to be automatically reset to the inverted value ("0" no alarm) after the replugging of the user module.
Light duration of status LED at operation indication	1 sec 2 sec <b>3 sec</b>	Defines the light-emitting period of the LED when acting as an operation indication.



**Push button 2, 3, 5gang with room thermostat (RTR) and display flush-mounted**  
**756627xx, 756637xx, 756657xx**

Control via display buttons	<p>No operation</p> <p><b>Limited operation</b></p> <p>Complete operation</p>	<p>The push button with RTR and display features several local operating levels:</p> <p>'Normal operation' and local control of room temperature regulator by actuating the display keys in order to shift the basic setpoint. Programming modes cannot be activated.</p> <p>Switch-over in programming mode possible → 'normal operation' incl. setpoint shifting and switch-over of operating mode and adjustments of different setpoints for heating and/or cooling.  Not for controller extension operation!</p> <p>Full access to the device with local control. In addition to the Limited operation it allows the user to have access to the room temperature timer (activating/deactivating timer and changing switching programs), display contrast adjustment and key lock (activating/deactivating the lock)  During controller extension operation access only to the contrast setting of the display and to the key lock (activating/deactivating the lock).</p>
-----------------------------	---	---

**Push button 2, 3, 5gang with room thermostat (RTR) and display flush-mounted**  
**756627xx, 756637xx, 756657xx**

Parameters		
Description:	Values:	Remarks:
 Display		
Operation LED	<b>ON</b> Automatic switch-off  Switching via object	The activation of the operation-LED can be configured.  The operation-LED is always on.  The operation-LED switches-on when pressing a key and automatically switches-off after a predetermined time.  The operation-LED is actuated via the object 22.
Kind of switching	<b>ON</b> Automatic switch-off	When the operation-LED is switched via the object it is possible to determine whether the LED will permanently switched-on with a „1“ telegram (“on”) or whether it will automatically switch-off after the parameterized time has elapsed.  Only for „operation-LED = switching via Object!“
Automatic switch off operation-LED (0...1200) * 1 sec	0 sec ... 1200 sec, <b>10 sec</b>	Determines the on-time of the operation-LED. The time can be post-triggered.  Only for „operation-LED = automatic switch-off! or „type of switching = automatic switch-off!“
Display of	Time / room temperature Time / outside temperature Outside temperature <b>Room temperature</b> Setpoint temperature Time Outside / room temperature Time / outside / setpoint temperature Time / room / setpoint temperature	It is possible to show different information on the display. They are to be selected here.

**Push button 2, 3, 5gang with room thermostat (RTR) and display flush-mounted**  
**756627xx, 756637xx, 756657xx**

Parameters		
Description:	Values:	Remarks:
 Push button function – disable		
Disabling function	<p><b>Push button not disabled</b></p> <p>Functions of all rockers like... rocker 1...n</p> <p>Single rocker disabled</p> <p>Push button disabled</p>	<p>This parameter determines the behaviour of the push button with activated disable function.</p> <p>The disable function is deactivated.</p> <p>If disable function is active, all the push button's rockers will behave like the one that is parameterized.</p> <p>With an active disable function it is possible to selectively disable individual rockers of the push button RTR.</p> <p>The entire push button is disabled with activated disable function.</p>
Polarity of blocking object	<p>Inverted (disable = 0)</p> <p><b>Not inverted (disable = 1)</b></p>	Determines the polarity of the disable object.
Function like rocker	<p><b>Rocker 1</b> (2 + 3 + 5 gang sensor)</p> <p>Rocker 2 (2 + 3 + 5 gang sensor)</p> <p>Rocker 3 (3 + 5 gang sensor)</p> <p>Rocker 4 (3 + 5 gang sensor)</p> <p>Rocker 5 (5 gang sensor)</p>	<p>If disable function is active, all the push button's rockers will behave like the one that is parameterized.</p> <p>Only for disabling function = „Function of all rockers as rocker 1...n".</p>
<p>Rocker X disabled ?</p> <p>X = 1 to 2 (2 gang sensor)</p> <p>X = 1 to 3 (3 gang sensor)</p> <p>X = 1 to 5 (5 gang sensor)</p>	<p><b>No</b></p> <p>Yes</p>	<p>Determines whether rocker X is disabled with active disable function, i.e. actuating a key (left and right) of this rocker will have no function.</p> <p>Only for disabling function = „disable individual rocker".</p>

**Push button 2, 3, 5gang with room thermostat (RTR) and display flush-mounted**  
**756627xx, 756637xx, 756657xx**

Parameters		
Description:	Values:	Remarks:
 Push button functions – General		
Rocker X: Concept of operation  X = 1 to 2 (2 rocker sensor) X = 1 to 3 (3 rocker sensor) X = 1 to 5 (5 rocker sensor)	<b>2 push buttons (2 objects)</b>  1 rocker (1 object)  No function	With the push button with RTR and display the individual rockers can be assigned two keys each or one rocker function.  Independently, the rocker X will be assigned two key functions.  The rocker X will be assigned one rocker function.  The rocker X has no function, i.e. an actuation of the key (left or right) has no affect and the status-LED's of this rocker cannot be addressed.

 Push button function – General – Push button 1 (2 gang, 3 gang and 5 gang)		
Function of push button	No function <b>Switching / pushing</b> Dimming Shutter Value transmitter 1-byte Value transmitter 2-byte Two telegrams Operating mode switch-over * Setpoint shifting * Light-scene extension / recall Room temperature timer control ** Controller extension ***	Determines the function of push button 1.  *: The operating mode switch-over and the setpoint shifting are only visible with activated room temperature regulator function!  **: The room temperature timer control can only be parameterized with enabled room temperature timer!  ***: The controller extension is visible only if controller extension functions activated!

Function of push button 1 = „No function“		
Function of status-LED	Always off Always ON Via status object	With function of push button 1 = „no function“, only the status-LED of the push button can be addressed via the relevant object. Pressing a push button has no effect.  The status-LED is always off.  The status-LED is always on.  The status-LED indicates the object status of the separate LED object.

 Push button function – General – Push button 1 – State of push button1 (2 gang, 3 gang and 5 gang)		
Polarity of status object	Inverted (on = 0) <b>Not inverted (on = 1)</b>	Defines the polarity of the status-LED object.  Only if „function of the status-LED“ = „via status object“!

**Push button 2, 3, 5gang with room thermostat (RTR) and display flush-mounted**  
**756627xx, 756637xx, 756657xx**

Function of push button 1 = „switching / pushing“		
Function of the status-LED	Always off Always ON Status indication (switching object) Inverted status indication (switching object) <b>Operation indication</b>  Via status object	Determines the function of the status-LED. The status-LED is always off. The status-LED is always on. The status-LED indicates the object status. The status-LED indicates the inverted object status. The status-LED lights up for the parameterized of time when push button is actuated. The status-LED indicates the object status of the separate LED object.
Command on pressing the push button	No function ON <b>TOGGLE</b> OFF	Determines the command transmitted on pressing the push button.
Command on releasing the push button	<b>No function</b> ON OFF TOGGLE	Determines the command transmitted on releasing the push button.

Parameters		
Description:	Values:	Remarks:
 Push button function – General – Push button 1 – State of push button 1 (2 gang, 3 gang and 5 gang)		
Polarity of status object	Inverted (on = 0) <b>Not inverted (on = 1)</b>	Defines the polarity of the status-LED object. Only if „function of the status-LED“ = „ via status object“!

Function of push button 1 = „dimming“		
Function of the status-LED	Always OFF Always ON Status indication (switching object) Inverted status indication (switching object) <b>Operation indication</b>  Via status object	Determines the function of the status-LED. The status-LED is always off. The status-LED is always on. The status-LED indicates the object status. The status-LED indicates the inverted object status. The status-LED lights up for the parameterized period of time when push button is actuated. The status-LED indicates the object status of the separate LED object.

**Push button 2, 3, 5gang with room thermostat (RTR) and display flush-mounted**  
**756627xx, 756637xx, 756657xx**

Command on pressing the push button, push button function	<p>Darker (OFF)</p> <p>Brighter (ON)</p> <p><b>Brighter/ darker (TOGGLE)</b></p>	<p>Determines the response to a push button-press.</p> <p>A short operation will trigger an OFF telegram, a long operation will trigger a dimming telegram (darker).</p> <p>A short-time operation will trigger an ON telegram; a long operation will trigger a dimming telegram (brighter).</p> <p>The internally stored switching status will be switched-over with a short-time push button-press. If the saved status is ON (OFF), an OFF- (ON) telegram will be triggered. A long operation will cause the transmission of a „darker“ telegram followed by a „brighter“ telegram and vice versa.</p>
Dimming brighter by	<p><b>100 %</b>      6 %</p> <p>50 %          3 %</p> <p>25 %          1,5 %</p> <p>12,5 %</p>	<p>Determines the maximum dimming increments for a dimming telegram. A dimming telegram can increase brightness by a maximum of X %.</p> <p>This parameter depends on the set push button function.</p>
Dimming darker by	<p><b>100 %</b>      6 %</p> <p>50 %          3 %</p> <p>25 %          1,5 %</p> <p>12,5 %</p>	<p>Determines the maximum dimming increments for a dimming telegram. A dimming telegram can reduce brightness by a maximum of X %.</p> <p>This parameter depends on the set push button function.</p>
Stop telegram	<p><b>YES</b></p> <p>NO</p>	<p>One or no telegram is transmitted on releasing the push button.</p>
Time between switching and dimming (0,1... 51) * 1 sec	<p>2..□.□.□.□.□.□ * □□    sec</p> <p>... 51 sec ,</p> <p>0.4 sec</p> <p>(increments: 0.1 sec)</p>	<p>Time from which on the function assigned to the operation(dimming) is executed.</p>
Telegram repetition	<p><b>NO</b></p> <p>YES</p>	<p>Periodical repetition of dimming telegram during a push button-press.</p>
Time between two telegrams	<p><b>200 ms</b>      750 ms</p> <p>300 ms        1 sec</p> <p>400 ms        2 sec</p> <p>500 ms</p>	<p>Time between two telegrams with set telegram repetition.</p> <p>A new dimming telegram is transmitted each time this time has elapsed.</p> <p>Only if telegram repetition = „yes“.</p>

 Push button function – General – Push button 1 – State of push button1 (2 gang, 3 gang and 5 gang)		
Polarity of status object	<p>Inverted (on = 0)</p> <p><b>Not inverted (on = 1)</b></p>	<p>Defines the polarity of the status-LED object.</p> <p>Only if „function of the status-LED“ = „ via status object“!</p>

**Push button 2, 3, 5gang with room thermostat (RTR) and display flush-mounted**  
**756627xx, 756637xx, 756657xx**

Function of push button 1 = „shutter“		
<p>Function of the status-LED</p>	<p>Always OFF                      Always ON  <b>Operation indication</b></p> <p>Via status object</p>	<p>Determines the function of the status-LED.                      The status-LED is always off.                      The status-LED is always on.                      The status-LED lights up for the parameterized period of time when push button is actuated.                      The status-LED indicates the object status of the separate LED object.</p>
<p>Operation concept</p>	<p><b>Step – Move - Step</b>                      Move - Step</p>	<p>Determines the telegram sequence following a push button-press.</p> <p><b>Step – Move – Step:</b></p> <p>Pressing a push button will transmit a STEP and time T1 is started ("time between step and move operation"). No other telegram will be transmitted, if the push button is released within T1. This step serves to stop a continuous run in progress.</p> <p>If the push button is pressed longer than T1, a MOVE is automatically transmitted after T1 has elapsed while time T2 ("Lamella adjustment time") is started. A STEP will be transmitted, if the push button is released again within T2. This function is used to adjust the Lamellas. T2 should correspond to the time required for a 180° rotation.</p> <p><b>Move – Step:</b></p> <p>Pressing a push button will transmit a MOVE and time T1 is started ("Lamella adjustment time"). A STEP will be transmitted, if the push button is released again within T1. This function is used to adjust the Lamellas. T1 should correspond to the time required for a 180° rotation of the Lamellas.</p>



**Push button 2, 3, 5gang with room thermostat (RTR) and display flush-mounted**  
**756627xx, 756637xx, 756657xx**

Time between step and move operation (0.1 ... 127.5) * 1 sec	0.1 sec ... 127.5 sec , 0.3 sec (increments: 0.1 sec)	Time from which on the function assigned to the operation is executed. Only if operation concept = „Short – Long – Short“.
Function of shutter push button	<b>UP</b>  DOWN  TOGGLE	A short-time operation will trigger a STEP telegram (UP); a long operation will trigger a MOVE telegram (up).  A short-time operation will trigger a STEP telegram (DOWN); a long operation will trigger a MOVE telegram (down).  With this setting the direction, which is internally stored and tracked via the bus, will be switched-over with each long actuation (MOVE). If a short-time actuation transmits a STEP telegram, then this STEP is always switched in the opposite direction of the last MOVE. Several STEP telegrams transmitted successively are always switched in the same direction.
Lamella adjustment time (0 ... 127.4) * 1 sec	0 sec ... 127.5 sec , 0.6 sec (increments: 0.1 sec)	Time during which a transmitted MOVE telegram can be terminated by releasing the push button (STEP). This function serves to adjust the Lamellas of a shutter.

Parameters		
Description:	Values:	Remarks:
 Push button function – General – Push button 1 – State of push button1 (2 gang, 3 gang and 5 gang)		
Polarity of status object	Inverted (on = 0) <b>Not inverted (on = 1)</b>	Defines the polarity of the status-LED object. Only if „function of the status-LED“ = „ via status object“!

**Push button 2, 3, 5gang with room thermostat (RTR) and display flush-mounted**  
**756627xx, 756637xx, 756657xx**

Function of push button 1= „Value transmitter 1-byte“		
Function of the status-LED	Always OFF Always ON <b>Operation indication</b>  Via status object	Determines the function of the status-LED. The status-LED is always off. The status-LED is always on. The status-LED lights up for the parameterized period of time when push button is actuated. The status-LED indicates the object status of the separate LED object.
Value (0...255)	0 ... 255, <b>255</b>	Determines the value to be transmitted.
Adjustment of values by long pressing of a push button	<b>Disabled</b> Enabled	Pressing the push button for at least 5 sec will cause the current value periodically to be reduced by the parameterized increments and transmitted. The previously transmitted value is saved after releasing the push button. This parameter determines whether a value adjustment is possible.
Time between two telegrams	0.5 sec; <b>1 sec</b> ; 2 sec; 3 sec	Time between two periodical telegrams (long push button-press).
Step width (1...10)	1 ... 10, <b>10</b>	Increments by which the adjusted value is reduced with a long push button-press.

Parameters		
Description:	Values:	Remarks:
 Push button function – General – push button 1 – status of push button 1 (2 gang, 3 gang and 5 gang)		
Polarity of status object	Inverted (on = 0) <b>Not inverted (on = 1)</b>	Defines the polarity of the status-LED object. Only if „function of the status-LED“ = „ via status object“!

**Push button 2, 3, 5gang with room thermostat (RTR) and display flush-mounted**  
**756627xx, 756637xx, 756657xx**

Function of push button 1= „Value transmitter 2-byte“														
Function of the status-LED	<p>Always OFF</p> <p>Always ON</p> <p><b>Operation indication</b></p> <p>Via status object</p>	<p>Determines the function of the status-LED.</p> <p>The status-LED is always off.</p> <p>The status-LED is always on.</p> <p>The status-LED lights up for the parameterized of time when push button is actuated.</p> <p>The status-LED indicates the object status of the separate LED object.</p>												
Function as	<p><b>Temperature value transmitter</b></p> <p>Brightness value transmitter</p> <p>Value transmitter</p>	<p>Determines the function to be executed.</p>												
Temperature value (0...40) * 1 °C	<p>0 ... 40 °C</p> <p>in 1 °C increments, <b>25 °C</b></p>	<p>Adjusting the temperature value to be transmitted.</p> <p>Only for the function as = „temperature value transmitter“</p>												
Brightness value (0...1500) * 1 lux	<p>0 ... 1500 lux</p> <p>in 50 lux increments, <b>500-lux</b></p>	<p>Adjusting the brightness value to be transmitted.</p> <p>Only for the function as = „brightness value transmitter“</p>												
Value (0...65535)	<p>0 ... 65535, <b>0</b></p>	<p>Adjusting the 2-byte value to be transmitted.</p> <p>Only for the function as „value transmitter“</p>												
Adjustment of values by long pressing of a push button	<p><b>Disabled</b></p> <p>Enabled</p>	<p>Pressing the push button for at least 5 sec will cause the current value periodically to be reduced by the parameterized increments and transmitted. The previously transmitted value is saved after releasing the push button.</p> <p>This parameter determines whether a value adjustment is possible.</p>												
Time between two telegrams	<p>0.5 sec; 1 sec; 2 sec; 3 sec</p>	<p>Time between two periodical telegrams (long push button-press).</p>												
Step width	<p>Temperature value transmitter:</p> <p><b>1 °C</b></p> <p>Brightness value transmitter:</p> <p><b>50 lux</b></p> <p>Value transmitter:</p> <table border="0"> <tr><td>1</td><td>75</td></tr> <tr><td>2</td><td>100</td></tr> <tr><td>5</td><td>200</td></tr> <tr><td><b>10</b></td><td>500</td></tr> <tr><td>20</td><td>750</td></tr> <tr><td>50</td><td>1000</td></tr> </table>	1	75	2	100	5	200	<b>10</b>	500	20	750	50	1000	<p>Increments by which the adjusted value is reduced with a long push button-press.</p>
1	75													
2	100													
5	200													
<b>10</b>	500													
20	750													
50	1000													

**Push button 2, 3, 5gang with room thermostat (RTR) and display flush-mounted**  
**756627xx, 756637xx, 756657xx**

Parameters		
Description:	Values:	Remarks:
 Push button function – General – Push button 1 – State of push button1 (2 gang, 3 gang and 5 gang)		
Polarity of status object	Inverted (on = 0) <b>Not inverted (on = 1)</b>	Defines the polarity of the status-LED object. Only if „function of the status-LED“ = „ via status object“!

Function of push button 1 = „Two telegrams“		
Function of the status-LED	Always OFF Always ON Status ind. (switching object) Inverted status indication (switching object) <b>Operation indication</b> Via status object	Determines the function of the status-LED. The status-LED is always off. The status-LED is always on. The status-LED indicates the object status. The status-LED indicates the invert. Object status. The status-LED lights up for the param. Time when push button is actuated. The status-LED indicates the object status of the separate LED object.
Type of 1 <sup>st</sup> object	<b>Switching</b> Value	This parameter defines the data format of the first communication object.
Type of 2 <sup>nd</sup> object	<b>Switching</b> Value	This parameter defines the data format of the second communication object.
Delay between the 1 <sup>st</sup> and 2 <sup>nd</sup> telegram	<b>YES</b> <b>NO</b>	The parameter determines whether a time between object 1 and object 2 will be activated (set to „yes“) or whether the telegrams of both objects will be transmitted directly one after another without any delay on pressing the push button. In this case the chronological sequence cannot be determined. Releasing the push button has no other or additional function.
Time between the 1 <sup>st</sup> and 2 <sup>nd</sup> telegram (1...1800sec)	1...1800sec; <b>10 sec</b>	This is where the time is defined that has to elapse before the telegram of the second object is transmitted on the bus. The transmission of the second object does not require to keep the push button pressed. Only with activated delay time!
Command when pressing push button for the 1 <sup>st</sup> object	No function ON <b>TOGGLE</b> OFF	This is where the command (ON, OFF) is parameterized which will be transmitted via the object 1 on the bus on pressing the push button. Only if „type of 1 <sup>st</sup> object“ = „switching“!
Command when pressing push button for the 2 <sup>nd</sup> object	No function ON <b>TOGGLE</b> OFF	This is where the command (ON, OFF) is parameterized which will be transmitted via the object 2 on the bus on pressing the push button. Only if „type of 2 <sup>nd</sup> object“ = „switching“!

**Push button 2, 3, 5gang with room thermostat (RTR) and display flush-mounted**  
**756627xx, 756637xx, 756657xx**

Value when pressing push button for the 1 <sup>st</sup> object	0...255; <b>255</b>	This is where the value (0...255) is parameterized which will be transmitted via the object 1 on the bus on pressing the push button. Only if „type of 1 <sup>st</sup> object“ = „value“!
Value when pressing push button for the 2 <sup>nd</sup> object	0...255; <b>255</b>	This is where the value (0...255) is parameterized which will be transmitted on the bus via the object 2 on pressing the push button. Only if „type of 2 <sup>nd</sup> object“ = „value“!

Parameters		
Description:	Values:	Remarks:
 Push button function – General – Push button 1 – State		of push button1 (2 gang, 3 gang and 5 gang)
Polarity of status object	Inverted (on = 0) <b>Not inverted (on = 1)</b>	Defines the polarity of the status-LED object. Only if „function of the status-LED“ = „ via status object“!

Function of push button 1 = „Operating mode switch-over“		
Function of the status-LED	always OFF always ON Indication of operating mode is active Indication of operating mode is inactive <b>Operation indication</b> Via status object	Determines the function of the status-LED. The status-LED is always off. The status-LED is always on. The status-LED lights up as soon as an operating mode is activated via the assigned push button. The status-LED lights up as soon as an operating mode is activated via the assigned push button. The status-LED lights up for the parameterized time when push button is actuated. The status-LED indicates the object status of the separate LED object.
Operating mode on pressing a push button	<b>Comfort operation</b> Standby operation Night operation Frost / heat protection operation Presence button	Determines the room temperature regulator function, which is to be activated when pressing a push button. *: The presence button can only be parameterized if „presence detection via presence button“ is enabled.

Parameters		
Description:	Values:	Remarks:
 Push button function – General – Push button 1 – State		of push button1 (2 gang, 3 gang and 5 gang)
Polarity of status object	Inverted (on = 0) <b>Not inverted (on = 1)</b>	Defines the polarity of the status-LED object. Only if „function of the status-LED“ = „ via status object“!

**Push button 2, 3, 5gang with room thermostat (RTR) and display flush-mounted**  
**756627xx, 756637xx, 756657xx**

Function of push button 1 = „Setpoint shifting“		
Function of the status-LED	Always OFF Always ON <b>Operation indication</b>	Determines the function of the status-LED. The status-LED is always off. The status-LED is always on. The status-LED lights up for the parameterized time when push button is actuated.
Command on pressing the push button	Via status object <b>Decrease step value</b> Increase step value	The status-LED indicates the object status of the separate LED object. It determines whether the step value for the basic temperature setpoint shifting for the internal controller takes place in negative direction (decreasing step value) or whether it takes place in positive direction (increasing step value). The increments for the temperature adjustment are determined via the controller (not via the controller extension)!

Push button function – General – Push button 1 – State of push button1 (2 gang, 3 gang and 5 gang)		
Polarity of status object	Inverted (on = 0) <b>Not inverted (on = 1)</b>	Defines the polarity of the status-LED object. Only if „function of the status-LED“ = „ via status object“!

Function of push button 1 = „Light-scene extension / recall“		
Function of the status-LED	Always OFF Always ON <b>Operation indication</b>	Determines the function of the status-LED. The status-LED is always off. The status-LED is always on. The status-LED lights up for the parameterized time when push button is actuated.
Function as	Via status object <b>Light-scene extension</b> Internal scene request *	The status-LED indicates the object status of the separate LED object. Defines the functionality of the scene recall. A operation will recall an ‘external light-scene’ via the light-scene extension object. A operation will recall an ‘internal’ scene. *: This setting can only be parameterized, if the light-scene function of the push button with RTR and display is enabled.
Light-scene (1...64)	1 ... 64, 1	Determines the light-scene number to be transmitted via the object. Only if „function as = light-scene extension“

**Push button 2, 3, 5gang with room thermostat (RTR) and display flush-mounted**  
**756627xx, 756637xx, 756657xx**

Scene extension 1...8	1 ... 8, 1	Determines the number of the internal scene to be recalled. Only if „function as = internal scene request“!
Memory function	<b>No</b> Yes	This parameter enables the memory function. If function is enabled, a long operation(> 5 sec) will trigger the transmission of a memory telegram or it will store the internal scene according to the parameterized number.

Parameters		
Description:	Values:	Remarks:
 Push button function – General – push button 1 – status of push button 1 (2 gang, 3 gang and 5 gang)		
Polarity of status object	Inverted (on = 0) <b>Not inverted (on = 1)</b>	Defines the polarity of the status-LED object. Only if „function of the status-LED“ = „ via status object“!

Function of push button 1 = „ room temperature timer control“		
Function of the status-LED	Always OFF Always ON Indication of room temperature timer is active Indication of room temperature timer is inactive <b>Operation indication</b>	Determines the function of the status-LED. The status-LED is always off. The status-LED is always on. The status-LED lights up as soon as the room temperature timer is activated via push button actuation. The status-LED lights up as soon as the room temperature timer is activated via push button actuation. The status-LED lights up for the parameterized time when push button is actuated.
Reaction on pressing a push button	Via status object Activate room temperature timer (ON) Deactivate room temperature timer (OFF) <b>Deactivate / activate room temperature timer (TOGGLE)</b>	The status-LED indicates the object status of the separate LED object. A operation will activate the timer. The parameterized switching programs will be executed. A operation will deactivate the timer. The parameterized switching programs will not be executed or suppressed. A operation will activate or deactivate the timer. Switching between executing and suppressing the switching programs













**Push button 2, 3, 5gang with room thermostat (RTR) and display flush-mounted**  
**756627xx, 756637xx, 756657xx**

 Push button function – General – Push button 1 – State of push button1 (2 gang, 3 gang and 5 gang)		
Polarity of status object	Inverted (on = 0) <b>Not inverted (on = 1)</b>	Defines the polarity of the status-LED object. Only if „function of the status-LED“ = „ via status object"!

Function of push button 1 = „controller extension“		
Function of the status-LED	Always OFF Always ON Indication of push button function is active Indication of push button function is inactive  <b>Operation indication</b>  Via status object	Determines the function of the status-LED. The status-LED is always off. The status-LED is always on. The status-LED lights up as soon as function is activated via the assigned push button. The status-LED lights up as soon as a function is deactivated via the assigned push button. The status-LED lights up for the parameterized time when push button is actuated. The status-LED indicates the object status of the separate LED object.
Function	<b>Normal operating mode switch-over</b> Forced operating mode switch-over Presence button Setpoint shifting	Defines the functionality of the controller extension.
Operating mode on pressing a push button	<b>Comfort operation</b> Standby operation Night operation Frost / heat protection operation	Determines the operating mode, which is to be transmitted on the bus and activated on the controller when pressing a push button. Only if „function“ = „normal operating mode switch-over"!
Operating mode on pressing a push button	Auto <b>Comfort operation</b> Standby operation Night operation Frost / heat protection operation	Determines the forced operating mode, which is to be transmitted on the bus and activated on the controller when pressing a push button. Only if „function“ = „forced operating mode switch-over"!
Command on pressing the push button	<b>Decrease step value</b> Increase step value	It determines whether the step value for the basic temperature setpoint shifting of the internal controller takes place in negative direction (decreasing step value) or whether it takes place in positive direction (increasing step value). The increments for the temperature adjustment are determined via the controller (not via the controller extension)! Only if „function“ = „setpoint shifting"!

**Push button 2, 3, 5gang with room thermostat (RTR) and display flush-mounted**  
**756627xx, 756637xx, 756657xx**

Parameters		
Description:	Values:	Remarks:
 Push button function – General – Push button 1 – State of push button1 (2 gang, 3 gang and 5 gang)		
Polarity of status object	Inverted (on = 0) <b>Not inverted (on = 1)</b>	Defines the polarity of the status-LED object. Only if „function of the status-LED“ = „ via status object“!

Parameters		
Description:	Values:	Remarks:
 Push button function – General – push button 2 see push button 1! (2 gang, 3 gang and 5 gang)		
 Push button function – General – push button 3 see push button 1! (2 gang, 3 gang and 5 gang)		
 Push button function – General – push button 4 see push button 1! (2 gang, 3 gang and 5 gang)		
 Push button function – General – push button 5 see push button 1! (3 gang and 5 gang)		
 Push button function – General – push button 6 see push button 1! (3 gang and 5 gang)		
 Push button function – General – push button 7 see push button 1! (5 gang)		
 Push button function – General – push button 8 see push button 1! (5 gang)		
 Push button function – General – push button 9 see push button 1! (5 gang)		
 Push button function – General – push button 10 see push button 1! (5 gang)		

Parameters		
Description:	Values:	Remarks:
 Push button function – General – rocker 1 (2 gang, 3 gang and 5 gang)		
Function of rocker 1	No function <b>Switching</b> Dimming Shutter Two telegrams Operating mode switch-over * Controller extension **	Determines the function of rocker 1.  *: The operating mode switch-over is visible only if the room temperature regulator function is switched-on!  **: The controller extension is visible only if the controller extension function switched-on!

**Function of rocker 1 = „No function“**

If function of rocker 1 = „no function“, only the status-LED of the rocker can be activated via the corresponding status object. Actuating a push button or a rocker has no effect.  
 Only status-LED parameter (see „status rocker 1“)!

Function of rocker 1 = „Switching“		
Command on pressing a rocker	Left = ---, right = --- Left = OFF, right = ON <b>Left = ON, right = OFF</b> Left = TOGGLE, right = TOGGLE Left = OFF, right = OFF Left = ON, right = ON	Determines the commands to be transmitted when pressing both push buttons.

**Push button 2, 3, 5gang with room thermostat (RTR) and display flush-mounted**  
**756627xx, 756637xx, 756657xx**

Function of rocker 1 = „Dimming“		
Command on pressing a rocker	<p><b>Left = Brighter (ON), right = Darker (OFF)</b></p> <p>Left = darker (OFF), right = brighter (ON)</p> <p>Left = TOGGLE, right = TOGGLE</p> <p>Left = Brighter (ON), right = brighter (ON)</p> <p>Left = darker (OFF), right = Darker (OFF)</p>	<p>Determines the response to a operationon the rocker.</p> <p>A short operation(left push button) will trigger an ON telegram; a long operation(left push button) will trigger a dimming telegram (brighter).</p> <p>A short operation(right push button) will trigger an OFF telegram; a long operation(right push button) will trigger a dimming telegram (darker).</p> <p>A short operation(left push button) will trigger an OFF telegram; a long operation(left push button) will trigger a dimming telegram (darker).</p> <p>A short operation(right push button) will trigger an ON telegram; a long operation(right push button) will trigger a dimming telegram (brighter).</p> <p>The internally stored switching status is toggled via a short-time push button-press. If the saved state is ON (OFF), an OFF- (ON) telegram will be triggered. A long operationwill transmit a „darker“ telegram followed by a „brighter“ telegram and vice versa.</p> <p>A short operation(left push button) will trigger an ON telegram; a long operation(left push button) will trigger a dimming telegram (brighter).</p> <p>A short operation(right push button) will also trigger an ON telegram; a long operation(right push button) will also trigger a dimming telegram (brighter).</p> <p>A short operation(left push button) will trigger an OFF telegram; a long operation(left push button) will trigger a dimming telegram (darker).</p> <p>A short operation(right push button) will also trigger an OFF telegram; a long operation(right push button) will also trigger a dimming telegram (darker).</p>
Dimming brighter by	<p><b>100 %</b>      6 %</p> <p>50 %          3 %</p> <p>25 %          1,5 %</p> <p>12,5 %</p>	<p>Determines the maximum dimming increments for a dimming telegram. A dimming telegram can increase brightness by a maximum of X %.</p>
Dimming darker by	<p><b>100 %</b>      6 %</p> <p>50 %          3 %</p> <p>25 %          1,5 %</p> <p>12,5 %</p>	<p>Determines the maximum dimming increments for a dimming telegram. A dimming telegram can reduce brightness by a maximum of X %.</p>
Stop telegram?	<p><b>Yes</b></p> <p>No</p>	<p>One or no telegram is transmitted when releasing one of the push buttons (left or right).</p>

**Push button 2, 3, 5gang with room thermostat (RTR) and display flush-mounted**  
**756627xx, 756637xx, 756657xx**

Time between switching and dimming (0,1 ... 51) * 1 sec	0.1 sec ... 51 sec , 0.4 sec (increments: 0.1 sec)	Time after which the function assigned to a long operation(dimming) is executed.								
Telegram repetition	<b>No</b> Yes	Enables the periodical repetition of dimming telegrams during a push button-press.								
Time between two dimming telegrams	<table border="0"> <tr> <td><b>200 ms</b></td> <td>750 ms</td> </tr> <tr> <td>300 ms</td> <td>1 sec</td> </tr> <tr> <td>400 ms</td> <td>2 sec</td> </tr> <tr> <td>500 ms</td> <td></td> </tr> </table>	<b>200 ms</b>	750 ms	300 ms	1 sec	400 ms	2 sec	500 ms		Time between two telegrams when telegram repetition is active. A new dimming telegram is transmitted after this time has elapsed. Only if telegram repetition = „yes“!
<b>200 ms</b>	750 ms									
300 ms	1 sec									
400 ms	2 sec									
500 ms										

**Push button 2, 3, 5gang with room thermostat (RTR) and display flush-mounted**  
**756627xx, 756637xx, 756657xx**

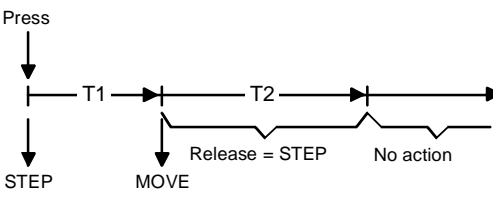
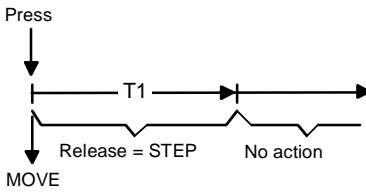
Function of rocker 1 = „Shutter“		
<p>Operation concept</p>	<p><b>Step – Move - Step</b>                      Move - Step</p>	<p>Determines the telegram sequence following a push button-press.</p> <p><b>Step – Move – Step:</b></p>  <p>Pressing the push button will transmit a STEP command and time T1 ("time between step and move operation") is started. No other telegram will be transmitted, if the push button is released within T1. This step serves to stop a continuous run in progress.</p> <p>If the push button is pressed longer than T1, a MOVE command is automatically transmitted after T1 has elapsed and time T2 ("Lamella adjustment time") is started. A STEP command will be transmitted, if the push button is released again within T2. This function is used for Lamella adjustment. T2 should correspond to the time required for a 180° rotation of the Lamellas.</p> <p><b>Move – Step:</b></p>  <p>Pressing a push button will transmit a MOVE command and time T1 ("Lamella adjustment time") is started. A STEP command will be transmitted, if the push button is released again within T1. This function is used for Lamella adjustment. T1 should correspond to the time required for a 180° rotation of the Lamellas.</p>
<p>Time between step and move operation (0.1 ... 127.5) * 1 sec</p>	<p>0.1 sec ... 127.5 sec , 0.3 sec (increments: 0.1 sec)</p>	<p>Time after which the function assigned to the operation is executed.                      Only if Operation concept = „Short – Long – Short“.</p>

**Push button 2, 3, 5gang with room thermostat (RTR) and display flush-mounted**  
**756627xx, 756637xx, 756657xx**

<p>Command on pressing a rocker</p>	<p><b>Left shutter UP / right shutter DOWN</b></p> <p>Left shutter DOWN / right shutter UP</p> <p>Left shutter TOGGLE / right shutter TOGGLE</p> <p>Left shutter UP / right shutter UP</p> <p>Left shutter DOWN / right shutter DOWN</p>	<p>A short operation(left push button) will trigger a STEP telegram (UP); a long operation(left push button) will trigger a MOVE telegram (up). A time operation(right push button) will trigger a STEP telegram (UP); a long operation(right push button) will trigger a MOVE telegram (down).</p> <p>A short operation(left push button) will trigger a STEP telegram (UP); a long operation(left push button) will trigger a MOVE telegram (down). A time operation(right push button) will trigger a STEP telegram (DOWN); a long operation(right push button) will trigger a MOVE telegram (Up).</p> <p>With this setting the direction, which is internally stored and tracked via the bus, will be switched-over with each long actuation (MOVE). If a short-time actuation transmits a STEP telegram, then this STEP is always switched in the opposite direction of the last MOVE. Several STEP telegrams transmitted successively are always switched in the same direction.</p> <p>A short operation(left push button) will trigger a STEP telegram (UP); a long operation(left push button) will trigger a MOVE telegram (up). A short operation(right push button) will also trigger a STEP telegram (UP); a long operation(right push button) will also trigger a MOVE telegram (Up).</p> <p>A short operation(left push button) will trigger a STEP telegram (DOWN); a long operation(left push button) will trigger a MOVE telegram (down). A short operation(right push button) will also trigger a STEP telegram (UP); a long operation(right push button) will also trigger a MOVE telegram (down).</p> <p>Time during which a transmitted MOVE telegram can be terminated by releasing the push button (STEP). This function serves to adjust the Lamellas.</p>
<p>Lamella adjustment time  (0 ... 127.4) * 1 sec</p>	<p>0 sec ... 127.5 sec , 0.6 sec  (increments: 0.1 sec)</p>	<p>Time during which a transmitted MOVE telegram can be terminated by releasing the push button (STEP). This function serves to adjust the Lamellas.</p>

**Push button 2, 3, 5gang with room thermostat (RTR) and display flush-mounted**  
**756627xx, 756637xx, 756657xx**

Function of push button 1 = „Two telegrams“		
Type of 1st object	<b>Switching</b> Value	This parameter defines the data format of the first communication object.
Type of 2nd object	<b>Switching</b> Value	This parameter defines the data format of the second communication object.
Delay between the 1st and 2nd telegram	<b>Yes</b> No	The parameter determines whether a time will be activated between object 1 and object 2 (set to „yes“) or whether the telegrams of both objects will be transmitted directly one after another without any delay on pressing the push button. In this case the chronological sequence cannot be determined.  Releasing the push button has no other or additional function.
Time between the 1st and 2nd telegram (1...1800sec)	1...1800sec; <b>10 sec</b>	This is where the time is defined that has to elapse before the telegram of the second object will be transmitted on the bus. The transmission of the second object does not require to keep the push button pressed. Only with activated delay time!
Command when pressing the left key for the 1st object	No function ON <b>TOGGLE</b> OFF	This is where the command (ON, OFF) is parameterized which will be transmitted on the bus via the object 1 when pressing the left push button. Only if „type of 1st object“ = „switching“!
Command when pressing the right key for the 1st object	No function ON <b>TOGGLE</b> OFF	This is where the command (ON, OFF) is parameterized which will be transmitted on the bus via the object 1 when pressing the right push button. Only if „type of 1st object“ = „switching“!
Command when pressing the left key for the 2nd object	No function ON <b>TOGGLE</b> OFF	This is where the command (ON, OFF) is parameterized which will be transmitted on the bus via the object 2 when pressing the left push button. Only if „type of 2nd object“ = „switching“!
Command when pressing the right key for the 2nd object	No function ON <b>TOGGLE</b> OFF	This is where the command (ON, OFF) is parameterized which will be transmitted on the bus via the object 2 when pressing the right push button. Only if „type of 2nd object“ = „switching“!
Value when pressing the left push button for the 1st object	0...255; <b>255</b>	This is where the value (0...255) is parameterized which will be transmitted on the bus via the object 1 on pressing the push button. Only if „type of 1st object“ = „value“!







**Push button 2, 3, 5gang with room thermostat (RTR) and display flush-mounted**  
**756627xx, 756637xx, 756657xx**

Value when pressing the right push button for the 1st object	0...255; <b>255</b>	This is where the value (0...255) is parameterized which will be transmitted on the bus via the object 1 when pressing the right push button. Only if „type of 1st object” = „value”!
Value when pressing the left push button for the 2nd object	0...255; <b>255</b>	This is where the value (0...255) is parameterized which will be transmitted on the bus via the object 2 on pressing the push button. Only if „type of 2nd object” = „value”!
Value when pressing the right push button for the 2nd object	0...255; <b>255</b>	This is where the value (0...255) is parameterized which will be transmitted on the bus via the object 2 when pressing the right push button. Only if „type of 2nd object” = „value”!





Function of rocker 1 = „Operating mode switch-over”		
Operating mode on pressing a push button	<b>Switch-over between the operating modes comfort, standby, night and frost / heat protection operation</b> (no other adjustment possible!)	Determines the function of rocker 1.

Function of rocker 1 = „Controller extension”		
Function	<b>Normal op. mode switch-over</b> Forced op. mode switch-over Presence button Setpoint shifting	Defines the functionality of the controller extension.
Operating mode on pressing a push button	<b>Switching over between the operating modes comfort, standby, night and frost / heat protection operation</b> (no other adjustment possible!)	A operation will switch-over between comfort, standby, night and frost/heat protection. Only if „function” = „normal operating mode switch-over”!
Operating mode on pressing a push button	<b>Switching over between the operating modes auto, comfort, standby, night and frost / heat protection operation</b> (no other adjustment possible!)	A operation will switch-over between auto, comfort, standby, night and frost/heat protection. Only if „function” = „forced operating mode switch-over”!
Command on pressing a push button	<b>Left decrease step value / right increase step value</b> Left increase step value / right decrease step value	It determines whether the step value for the basic temperature setpoint shifting takes place in negative direction upon operation(decreasing step value) or whether it takes place in negative direction upon operation(increasing step value). Only if „function” = „setpoint shifting”!

**Push button 2, 3, 5gang with room thermostat (RTR) and display flush-mounted**  
**756627xx, 756637xx, 756657xx**

Parameters		
Description:	Values:	Remarks:
 Rocker 2 see rocker 1! (2 gang, 3 gang and 5 gang)		
 Rocker 3 see rocker 1! (3 gang and 5 gang)		
 Rocker 4 see rocker 1! (5 gang)		
 Rocker 5 see rocker 1! (5 gang)		

Parameters		
Description:	Values:	Remarks:
 Push button function – general – rocker 1 – state of rocker 1 (2 gang, 3 gang and 5 gang)		
Function of rocker 1 = „no function“, „switching“, „dimming“, „shutter“, „two telegrams“, „operating mode switch-over“ and „controller extension“.		
Function of left status-LED	Always OFF Always ON <b>Via status object</b>	Determines how the status-LED of the left rocker is activated. It can be either permanently switched on or off or alternatively it can be activated via its own status communication object.
Polarity of status object left	Inverted (on = 0) <b>Not inverted (on = 1)</b>	Determines the polarity of the status object of the left status-LED. Only if „function of left status-LED“ = „ via status object“!
Function of right status-LED	Always OFF Always ON <b>Via status object</b>	This is where it is determined how the status-LED of the right rocker is addressed. It can be either switched on or off at all times or alternatively it can be addressed via its own status communication object.
Polarity of status object right	Inverted (on = 0) <b>Not inverted (on = 1)</b>	Determines the polarity of the status object of the right status-LED. Only if „function of left status-LED“ = „ via status object“!

Parameters		
Description:	Values:	Remarks:
 Push button function – general – rocker 2 – state of rocker 2 see state of rocker 1 (2 gang, 3 gang and 5 gang)		
 Push button function – general – rocker 3 – state of rocker 3 see state of rocker 1 (3 gang and 5 gang)		
 Push button function – general – rocker 4 – state of rocker 4 see state of rocker 1 (5 gang)		
 Push button function – general – rocker 5 – state of rocker 5 see state of rocker 1 (5 gang)		



**Push button 2, 3, 5gang with room thermostat (RTR) and display flush-mounted**  
**756627xx, 756637xx, 756657xx**

Parameters		
Description:	Values:	Remarks:
 Room temperature regulator function		
Operating mode switch-over	<b>Via value (1-byte)</b>  Via switching (4 x 1-bit)	The switch-over of the operating modes via the bus takes place according to the KONNEX specification via a 1-byte value object. In addition, a higher-ranking forced-object is available for this setting.  The 'classic' switch-over of the operating modes via the bus is via separate 1-bit objects.
Control circuits (VZ)	<b>1 control circuit</b>  2 control circuits	The room temperature regulator addresses only one control circuit.  The room temperature regulator can address up to two control circuits.
Heating / cooling mode (VZ)	<b>Heating</b> <b>Cooling</b> Heating and cooling * Basic and additional heating * Basic and additional cooling * Basic /additional heating/cooling *	Setting the heating/cooling mode  *: The „heating and cooling“ mixed-mode and the two stage controlled operation are not available when using two control circuits!
Additional stage inhibit object (VZ)	<b>No</b>  Yes	The additional stages can be separately disabled via the bus. The parameter enables the disable object.  The additional stages cannot be separately disabled.  The additional stages cannot be separately disabled via the disable object.  Only if in two-stage heating or cooling mode!
Send variable heating and cooling to one common object (VZ)	<b>No</b> Yes	If the parameter is set to „yes“, the actuating variable will be transmitted on a shared object during heating or cooling. This function is used, if the same heating system is used to cool the room in the summer and used to heat the room in the winter.  Only with „heating and cooling“ mixed-mode, if applicable, with additional stages!
Type of heating control (if applicable, for basic and additional stage) (VZ)	<b>Continuous PI control</b> Switching PI control (PWM) Switching 2-point control (ON/OFF)	Selecting a control algorithm (PI or 2-point) with data format (1-byte or 1-bit) for the heating system.

**Push button 2, 3, 5gang with room thermostat (RTR) and display flush-mounted**  
**756627xx, 756637xx, 756657xx**

Type of heating (if applicable, for basic and additional stage) (VZ)	<b>Hot water heating (5 K / 150 min)</b> Underfloor heating (5 K / 240 min) Electric heating (4 K / 100 min) Fan convector (4 K / 90 min) Split unit (4 K / 90 min) Via control parameter	Adapting the PI algorithm to different heating systems using experience values for the proportional range and reset time control parameters.  Separate input of control parameter. Only if „type of heating control“ = „PI“!
Proportional range heating (10 ... 127) * 0.1 K (VZ)	10...127, <b>50</b>	Separate setting of the „proportional range“ control parameter. Only if „type of heating control“ = „via control parameter“!
Reset time heating (0 ... 255) * 1 min; 0 = inactive (VZ)	0...255, <b>150</b>	Separate setting of the „reset time“ control parameter. Only if „type of heating control“ = „via control parameter“!
Heating 2-point controller hysteresis upper limit (5 ... 127) * 0.1 K (VZ)	5...127, <b>5</b>	Definition of switch-on and switch-off temperature for heating. Only if „type of heating control“ = „2-point“!
Heating 2-point controller hysteresis lower limit (-128 ... -5) * 0.1 K (VZ)	-128...-5, <b>-5</b>	Definition of switch-on and switch-off temperature for heating. Only if „type of heating control“ = „2-point“!
Type of cooling control (if applicable, for basic and additional stage) (VZ)	<b>Continuous PI control</b> Switching PI control PWM) Switching 2-point control (ON/OFF)	Selecting a control algorithm (PI or 2-point) with data format (1-byte or 1-bit) for the cooling system.  Only if „Send variable heating and cooling to one common object“ = „no“! If „Send variable heating and cooling to one common object“ = „yes“, the parameter settings for „type of heating control“ will be accepted.
Type of cooling (if applicable, for basic and additional stage) (VZ)	<b>Cooling ceiling (5 K / 240 min)</b> Fan convector (4 K / 90 min) Split unit (4 K / 90 min)  Via control parameter	Adapting the PI algorithm to different cooling systems using experience values for the proportional range and reset time control parameters.  Separate input of control parameter. Only if „type of cooling control“ = „PI“!
Proportional range cooling (10 ... 127) * 0.1 K (VZ)	10...127, <b>50</b>	Separate setting of the „proportional range“ control parameter. Only if „type of cooling control“ = „via control parameter“!

**Push button 2, 3, 5gang with room thermostat (RTR) and display flush-mounted**  
**756627xx, 756637xx, 756657xx**

Reset time cooling (0 ... 255) * 1 min; 0 = inactive (VZ)	0...255, <b>240</b>	Separate setting of the „reset time“ control parameter. Only if „type of cooling control“ = „via control parameter“!
Cooling 2-point controller hysteresis upper limit (5 ... 127) * 0.1 K (VZ)	5...127, <b>5</b>	Definition of switch-on and switch-off temperatures for cooling. Only if „type of cooling control“ = „2-point“!
Cooling 2-point controller hysteresis lower limit (-128 ... -5) * 0.1 K (VZ)	-128...-5, <b>-5</b>	Definition of switch-on and switch-off temperatures for cooling Only if „type of cooling control“ = „2-point“!
Operation of controller inhibitable	<b>No</b> Always disabled Via bus	It is possible to disable the local control of the room temperature regulator (all rockers). If control is actively disabled the „  “ symbol will appear on the display. Disable function is deactivated. Always disables the controller control. Enables the „controller operation disable“ object 39.
Switch-off controller (dew point)	<b>NO</b> Via bus	This parameter enables the „disable controller „ object 40. There is no control until enabled (actuating variables = 0). If controller is actively disabled (dew point mode), the „  “ symbol will appear on the display.
Frost/heat protection	Automatic frost protection  <b>Via window status</b>	It is possible to determine how the room temperature regulator switches into the frost/heat protection. The frost protection automatic is activated. Depending on the room temperature this allows an automatic switch-over into the frost protection mode. The switch-over into the frost/heat protection takes place via the „window status“ object.
Automatic frost protection	<b>Off</b> 0.2 K / min. 0.3 K / min. 0.4 K / min. 0.5 K / min. 0.6 K / min.	Determines the decrease temperature by which the room temperature has to decrease within one minute in order for the controller to switch into the frost protection mode. The „OFF“ setting will deactivate the frost protection automatic.  Only if „frost/heat protection = Automatic frost protection“!

**Push button 2, 3, 5gang with room thermostat (RTR) and display flush-mounted**  
**756627xx, 756637xx, 756657xx**

<p>Frost protection period in automatic mode (1...255) * 1 min.</p>	<p>1 ... 255, <b>20</b></p>	<p>Defines the time after which the controller (in frost protection automatic) will automatically deactivate the frost protection again.</p>
<p>Window status delay (0...255) * 1 min.; 0 = inactive</p>	<p>0 ... 255, <b>0</b></p>	<p>Defines the delay time after which the frost/heat protection will be activated via the window status.</p>
<p>Switch-over between heating and cooling</p>	<p><b>Automatically</b></p> <p>Via object</p>	<p>Only with enabled automatic frost protection!</p> <p>Defines the delay time after which the frost/heat protection will be activated via the window status.</p> <p>Only if „frost/heat protection = via window status“!</p>
<p>Heating / cooling switch-over after a reset</p>	<p><b>Heating</b> Cooling Heating/cooling switch-over before reset</p>	<p>In parameterized mixed mode it is possible to switch-over between heating and cooling. Depending on the operating mode and the room temperature, the switch-over takes place automatically.</p> <p>Switch-over takes place solely via the „heating/cooling switch-over“ object 35.</p> <p>Only with „heating and cooling“ or „basic / additional heating/cooling“ mixed modes!</p>
<p>Automatic heating/cooling switch-over transmission</p>	<p><b>On changing the heating/cooling</b> On changing the output value</p>	<p>Determines the heating/cooling mode that after a return of bus voltage.</p> <p>Only if „switch-over between heating and cooling = via object“!</p>
<p>Cyclical transmission heating/cooling switch-over (0...255) * 1 min; 0 = inactive</p>	<p>0 ... 255, <b>0</b></p>	<p>Determines when a telegram will be automatically transmitted on the bus via the „heating/cooling switch-over“ object 35.</p> <p>Only if „switch-over between heating and cooling = automatically“!</p>
<p>Valve protection</p>	<p><b>No</b> Yes</p>	<p>Determines whether the current object status of „heating/cooling switch-over“ object 35 is to be periodically output on the bus (with automatic switch-over). The cycle time may be adjusted. The „0“ setting will deactivate the periodic transmission of the object value.</p> <p>Only if „switch-over between heating and cooling = automatically“!</p> <p>The valve is periodically opened (every 24 hours). Works against calcification and thus prevents the valve to become stuck.</p>

**Push button 2, 3, 5gang with room thermostat (RTR) and display flush-mounted**  
**756627xx, 756637xx, 756657xx**

Parameters		
Description:	Values:	Remarks:
 Room temperature function – Set Point Values		
Own setpoints for 2nd control circuit	<b>No</b> Yes	When both control circuits are used, the second circuit can have its own setpoints. The „yes“ setting will enable the setpoint presetting of the second control circuit.  Only if „control circuits = 2 control circuits“!
Basic temperature after reset (7.0 ... 40.0) * 1 °C	7.0 °C ... + 40 °C, 21 °C	Determines the basic setpoint after the initialization.
Basic temperature in the 2 <sup>nd</sup> control circuit after reset (7.0 ... 40.0) * 1 °C	7.0 °C ... + 40 °C, 21 °C	Determines the basic setpoint of the second control circuit after the initialization.  Only if „own setpoints for 2nd control circuit = yes“!
Accept modification of shift of basic setpoint value permanently	<b>No</b> Yes	The temperature of the current operating mode of both control circuits can be adapted via the basic setpoint shifting (via display push buttons). The temperature can be shifted upwards and downwards within the predetermined value range.  The „no“ setting will delete the temperature shift when switching-over into another operating mode. The „YES“ setting will keep the temperature shift when switching-over into another operating mode.
Modification of the basic temperature setpoint value	<b>Deactivated</b> Permit via display buttons Permit via object Permit via dis. buttons a. bus	Determines whether a change of the basic temperature of the first control circuit is possible via the bus or locally on the device.
Modification of the basic temperature setpoint in the 2 <sup>nd</sup> control circuit	<b>Deactivated</b> Permit via object	Determines whether a change of the basic temperature of the second control circuit is possible via the bus or locally on the device.  Only if „Own setpoints for 2nd control circuit = yes“!
Accept modification of the basic temperature setpoint value permanently	<b>No</b> Yes	This parameter determines whether the basic temperature value, which has been adjusted via the bus or locally on the device, is to be permanently (set to „yes“) or solely temporarily (set to „no“) stored in memory.  When set to „yes“ the changed basic value will remain even after switching-over into another the operating mode and after a reset.



**Push button 2, 3, 5gang with room thermostat (RTR) and display flush-mounted  
756627xx, 756637xx, 756657xx**

Modification of the setpoints „cooling“	<b>deactivated</b> Permit via display buttons	<p>Only if „Modification of the basic temperature setpoint value“ = „permit via display buttons“, „permit via bus“ or „permit via display buttons and bus“!</p> <p>Allows to change the cooling setpoints of the first control circuit on the device when in mixed mode. The „temperatures cooling“ menu – with deactivated change – is not accessible in programming mode!</p> <p>Only if „heating/cooling mode“ = „heating and cooling“, if applicable, with additional stages!</p>
1 <sup>st</sup> control circuit standby temperature change	<b>deactivated</b> Permit via display buttons	Allows to change the cooling setpoints of the first control circuit on the device.
1 <sup>st</sup> control circuit night temperature change	<b>deactivated</b> Permit via display buttons	Allows to change the night temperature of the first control circuit on the device.
Frost protection setpoint temperature (7...40) * 1 °C	7 °C ... + 40 °C, <b>7 °C</b>	<p>Determines the set-temperature with activated frost protection.</p> <p>Only if „heating/cooling mode“ = „heating“ or „heating and cooling“, if applicable, with additional stages!</p>
Heat protection setpoint temperature (7...45) * 1 °C	7 °C ... + 45 °C, <b>35 °C</b>	<p>Determines the set-temperature with activated heat protection.</p> <p>Only if „heating/cooling mode“ = „cooling“ or „heating and cooling“, if applicable, with additional stage!</p>
Dead band position	<p><b>Symmetrical</b></p> <p>Asymmetrical</p>	<p>The comfort set-temperatures for heating and cooling are derived from the basic setpoint in consideration of the adjusted Dead band. The Dead band (temperature zone for which there is neither heating nor cooling) is the difference between the comfort set-temperatures.</p> <p>Symmetrical: The Dead band preset in the ETS plug-in is divided in two parts at the basic setpoint. The comfort set-temperatures are derived directly from the basic setpoint resulting from the half Dead band.</p> <p>Asymmetrical: With this setting the comfort set-temperature for heating equals the basic setpoint! The preset Dead band takes only effect from the basic setpoint in the direction of comfort temperature for cooling. Thus the comfort set-temperature for cooling is derived directly from the comf. setpoint for heating.</p> <p>Only with the „heating and cooling“ or „basic / additional heating/cooling“ mixed modes!</p>

**Push button 2, 3, 5gang with room thermostat (RTR) and display flush-mounted**  
**756627xx, 756637xx, 756657xx**

Dead band between heating and cooling (0...127) * 0.1 K	0 ... 127, <b>20</b>	The comfort set-temperatures for heating and cooling are derived from the basic setpoint in consideration of the adjusted Dead band. The Dead band (temperature zone for which there is neither heating nor cooling) is the difference between the comfort set-temperatures.  Only with the „heating and cooling“ or „basic / additional heating/cooling“ mixed modes!
Dead band shift	<b>Deactivated</b> Permit via display push buttons	Determines whether the Dead band and thus the comfort temperature for cooling may be adjusted on the device in programming mode with „temperature values cooling“.  Only with „heating and cooling“ or „basic /additional heating/cooling“ and if „Modification of the setpoints „cooling“ = permit via display buttons“!
Difference between basic and additional stages (0...127) * 0.,1 K	0 ... 127, <b>20</b>	In a two stage control mode it is necessary to determine the temperature difference to the basic stage with which the additional stage is to be incorporated into the control  Only in two stage control operation!
Transmission at setpoint temperature modification by (0...255) * 0.1 K; 0 = no autom. transmission	0 ... 255, <b>1</b>	Determines the size of the value change required to automatically transmit the current value via the „set-temperature“ object. When using both control circuits with separate setpoints both setpoints can be transmitted.
Cyclical transmission of setpoint temperature (0...255) * 1 min; 0 = inactive	0 ... 255, <b>0</b>	Determines whether the set-temperature is to be periodically output via the „set-temperature“ object. When using both control circuits with separate setpoints both setpoints can be transmitted.
Upward adjustment of basic setpoint temperature (0...10) * 1 K	0 ... 10, <b>3</b>	Determines the maximum adjustment range for the upward adjustment of the basic set-temperature.  (cf. „Changing the setpoint of the basic temperature“ parameter!)
Downward adjustment of basic setpoint temperature (-10...0) * 1 K	-10 ... 0, <b>-3</b>	Determines the maximum adjustment range for the downward adjustment of the basic set-temperature.  (cf. „Changing the setpoint of the basic temperature“ parameter!)

**Push button 2, 3, 5gang with room thermostat (RTR) and display flush-mounted**  
**756627xx, 756637xx, 756657xx**

Lower the setpoint temperature during standby operation (heating) (-128...0. * 0,1 K	-128 ... 0, <b>-20</b>	The value by which the standby set-temperature for heating is lowered compared to the basic setpoint.  Only if „heating/cooling mode“ = „heating“ or „heating and cooling“, if applicable, with additional stages!
Lower the setpoint temperature during night operation (heating) (-128...0. * 0,1 K	-128 ... 0, <b>-40</b>	The value by which the night set-temperature for heating is lowered compared to the basic setpoint.  Only if „heating/cooling mode“ = „heating“ or „heating and cooling“, if applicable, with additional stages!
Lower the setpoint temperature during standby operation (heating – 2nd contr. circuit) (-128...0. * 0,1 K	-128 ... 0, <b>-20</b>	The value by which the standby set-temperature for heating is lowered compared to the basic setpoint.  Only if „heating/cooling mode“ = „heating“ and only with two control circuits with separate setpoints!
Lower the setpoint temperature during night operation (heating – 2nd contr. circuit) (-128...0. * 0,1 K	-128 ... 0, <b>-40</b>	The value by which the night set-temperature for heating is lowered compared to the basic setpoint.  Only if „heating/cooling mode“ = „heating“ and only with two control circuits with separate setpoints!
Raise the setpoint temperature during standby operation (cooling) (0...127) * 0,1 K	0 ... 127, <b>20</b>	The value by which the standby set-temperature for cooling is raised compared to the basic setpoint.  Only if „heating/cooling mode“ = „cooling“ or „heating and cooling“, if applicable, with additional stages!
Raise the setpoint temperature during night operation (cooling) (0...127) * 0,1 K	0 ... 127, <b>40</b>	The value by which the night set-temperature for cooling is raised compared to the basic setpoint.  Only if „heating/cooling mode“ = „cooling“ or „heating and cooling“, if applicable, with additional stages!
Raise the setpoint temperature during standby operation (cooling – 2 <sup>nd</sup> contr. circuit) (0...127) * 0,1 K	0 ... 127, <b>20</b>	The value by which the standby set-temperature for cooling is raised compared to the basic setpoint.  Only if „heating/cooling mode“ = „cooling“ and only with two control circuits with separate setpoints!
Raise the setpoint temperature during night operation (cooling – 2 <sup>nd</sup> contr. circuit) (0...127) * 0,1 K	0 ... 127, <b>40</b>	The value by which the night set-temperature for cooling is raised compared to the basic setpoint.  Only if „heating/cooling mode“ = „cooling“ and only with two control circuits with separate setpoints!

**Push button 2, 3, 5gang with room thermostat (RTR) and display flush-mounted**  
**756627xx, 756637xx, 756657xx**

Parameters		
Description:	Values:	Remarks:
 Room temperature regulator function – functionality		
Operation mode after reset	Restore operation mode before reset <b>Comfort operation</b> Standby operation Night operation Frost / heat protection operation	Parameter for setting the operating mode after the push button's initialisation phase (e.g. after the return of bus voltage).  If set to „restore operation mode before reset“, a frequent change of the operating mode (several times a day) might affect the product life of the device as the non-volatile storage is designed only for storing permanent values.
Presence detection	<b>None</b> Via object	If a person is present in the room, it is best to have the controller switch into the comfort mode or comfort mode extension. This parameter determines which detector is used.  There will be no presence detection.  The presence detection takes place via a separate object or via a presence button on the push button (push button function).
Type of presence detection	Presence button    Presence detector	The presence detection takes place via a presence button on the push button (push button function) or via the presence object (e.g. external push button). In case of a detected presence the comfort mode extension or the comfort mode will be activated.  The presence detection takes place via an external presence detector. The detector will be coupled via the presence object. If a presence is detected, the comfort mode will be called for as long as the presence detector detects movement.  Only if „presence detection = switching via Object!“
Length of comfort prolongation (0...255) * 1 min; 0 = off	0 ... 255, <b>30</b>	During a presence detection the controller may temporarily switch into the comfort extension – depending on the active operating mode. The parameter determines the time after which the comfort mode extension is automatically terminated.  Only if „type of presence detection = „presence button“!

**Push button 2, 3, 5gang with room thermostat (RTR) and display flush-mounted**  
**756627xx, 756637xx, 756657xx**

Parameters		
Description:	Values:	Remarks:
 Room temperature regulator function – room temperature measuring (FA)		
Temperature detection	<p><b>Internal sensor</b></p> <p>External sensor</p> <p>Internal and external sensor</p>	<p>Determines which sensor will be used for the room temperature measurement of the first control circuit.</p> <p>Internal sensor: Sensor installed inside the push button RTR.</p> <p>External sensor: an external sensor coupled via the bus, e.g. for complicated measuring conditions (swimming pools or similar).</p> <p>Internal and external sensor: Both sensors are used, for example, in large rooms.</p> <p>Only with one control circuit!</p>
Creating of measuring value internal against external	<p>10 % to 90 %</p> <p>20 % to 80 %</p> <p>30 % to 70 %</p> <p>40 % to 60 %</p> <p><b>50 % to 50 %</b></p> <p>60 % to 40 %</p> <p>70 % to 30 %</p> <p>80 % to 20 %</p> <p>90 % to 10 %</p>	<p>Determines the weighting of the measured temperature value for the internal and external sensors.</p> <p>That results in an overall value, which will be used for the further interpretation of the room temperature.</p> <p>Only with one control circuit and if „temperature detection = internal and external sensor“!</p>
Adjustment internal sensor (-128...127) * 0.1 K	-128 ... 127, <b>0</b>	<p>Determines the value by which the internal sensor's room temperature value is calibrated.</p> <p>Only if „temperature detection = internal sensor“ or „internal and external sensor“ or in case of two control circuits!</p>
Adjustment external sensor (-128...127) * 0.1 K	-128 ... 127, <b>0</b>	<p>Determines the value by which the external sensor's room temperature value is calibrated.</p> <p>Only if „temperature detection = external sensor“ or „internal and external sensor“ or in case of two control circuits!</p>
Scanning time for external sensor (0...255) * 1 min; 0 = inactive	0 ... 255, <b>0</b>	<p>Determines the measurement period for the external sensor's temperature value.</p> <p>"0" = sensor automatically transmits its temperature value.</p> <p>Only if „temperature detection = external sensor“ or „internal and external sensor“ or in case of two control circuits!</p>
Transmission at room temperature modification by (0..255) * 0.1 K; 0 = no automatic transmission	0 ... 255, <b>3</b>	<p>Determines the size of the value change for the room temperature of the first control circuit to automatically transmit the current value on the bus via the „actual temperature“ object 23.</p>

**Push button 2, 3, 5gang with room thermostat (RTR) and display flush-mounted**  
**756627xx, 756637xx, 756657xx**

Cyclical transmission of room temperature (0...255) * 1 min; 0 = inactive	0 ... 255, <b>15</b>	Determines whether or when the determined room temperature of the first control circuit is to be periodically output via the „actual temperature“ object 23.
Send temperature alarm via object	<b>No</b> Yes	This parameter enables the „temperature alarm“ function if set to „yes“.
Lower temperature limit value (0...40 °C)	0...40 °C; <b>7 °C</b>	Lower temperature value for temperature alarm. Only if „Send temperature alarm via object“ = „yes“!
Upper temperature limit value (0...40 °C)	0...40 °C; <b>35 °C</b>	Upper temperature value for temperature alarm. Only if „Send temperature alarm via object“ = „yes“!

Parameters		
Description:	Values:	Remarks:
 Room temperature regulator function – variable and status output (FA)		
Automatic transmission at modification by (0...100) * 1 %; 0 = inactive	0 ... 100, <b>3</b>	Determines the size of the actuating variable change that will automatically transmit the continuous actuating variables via the actuating variable objects. Only if at least one type of control is parameterized to „continuous PI control“!
Cycle time of the switching variable (1...255) * 1 min	1 ... 255, <b>15</b>	Determines the cycle time for the pulse width modulated actuating variable (PWM). Only if at least one type of control is parameterized to „switching PI control (PWM)“!
Cycle time for automatic transmission (0...255) * 1 min; 0 = inactive	0 ... 255, <b>10</b>	Time interval for the periodic transmission of the actuating variable via the actuating variable objects. Only if at least one type of control is parameterized to „continuous PI control“ or „switching 2-point control“!
Output of the heating variable	inverted  <b>Normal</b>	continuous: Actuating variable = 100 % - normal actuating variable switching: Actuating variable = 1 – normal actuating variable normal actuating variable output heating Only if „heating/cooling mode = heating“ or „heating and cooling“!

**Push button 2, 3, 5gang with room thermostat (RTR) and display flush-mounted**  
**756627xx, 756637xx, 756657xx**

Output of the heating variable in the 2 <sup>nd</sup> control circuit	inverted  <b>Normal</b>	continuous: Actuating variable = 100 % - normal actuating variable switching: Actuating variable = 1 – normal actuating variable normal actuating variable output heating 2 <sup>nd</sup> control circuit Only for one control circuit if „heating/cooling mode = heating“!
Output of the heating basic stage variable	inverted  <b>Normal</b>	continuous: Actuating variable = 100 % - normal actuating variable switching: Actuating variable = 1 – normal actuating variable normal actuating variable output basic stage heating Only if „heating/cooling mode= basic and additional heating“ or „basic/additional heating/cooling“!
Output of the heating additional stage variable	inverted  <b>Normal</b>	continuous: Actuating variable = 100 % - normal actuating variable switching: Actuating variable = 1 – normal actuating variable normal actuating variable output additional stage heating Only if „heating/cooling mode= basic and additional heating“ or „basic/additional heating/cooling“!
Output of the cooling variable	inverted  <b>Normal</b>	continuous: Actuating variable = 100 % - normal actuating variable switching: Actuating variable = 1 – normal actuating variable normal actuating variable output cooling Only if „heating/cooling mode = cooling“ or „heating and cooling“!
Output of the cooling variable in the 2 <sup>nd</sup> control circuit	inverted  <b>Normal</b>	continuous: Actuating variable = 100 % - normal actuating variable switching: Actuating variable = 1 – normal actuating variable normal actuating variable output cooling 2 <sup>nd</sup> control circuit Only for two control circuits if „heating/cooling mode = cooling“!



**Push button 2, 3, 5gang with room thermostat (RTR) and display flush-mounted**  
**756627xx, 756637xx, 756657xx**

Output of the cooling basic stage variable	<p>inverted</p> <p><b>Normal</b></p>	<p>continuous: Actuating variable = 100 % - normal actuating variable</p> <p>switching: Actuating variable = 1 – normal actuating variable</p> <p>normal actuating variable output basic stage cooling</p> <p>Only if „heating/cooling mode= basic and additional cooling“ or „basic/additional heating/cooling“!</p>
Output of the cooling additional stage variable	<p>inverted</p> <p><b>Normal</b></p>	<p>continuous: Actuating variable = 100 % - normal actuating variable</p> <p>switching: Actuating variable = 1 – normal actuating variable</p> <p>normal actuating variable output additional stage cooling</p> <p>Only if „heating/cooling mode= basic and additional cooling“ or „basic/additional heating/cooling“!</p>
Heating indication	<p><b>No</b></p> <p>Yes</p>	<p>Enables the „heating“ message function and thus the „message heating“ object 37. The message applies solely to the first control circuit.</p>
Cooling indication	<p><b>No</b></p> <p>Yes</p>	<p>Enables the „cooling“ message function and thus the „message cooling“ object 38. The message applies solely to the first control circuit.</p>
Status indication of controller	<p><b>No status</b></p> <p>Controller general</p> <p>Transmit individual state</p>	<p>The controller can output its current operating status.</p> <p>No status will be output.</p> <p>The controller status is generally output by the 1-byte object (<i>“controller status”</i>).</p> <p>The controller status preset by the „individual state“ parameter will be output via the 1-bit object (Object 36 „<i>status indication of controller status</i>“).</p>
Single state	<p><b>Comfort operation activated</b></p> <p>Standby operation activated</p> <p>Night operation activated</p> <p>Frost/heat protection active</p> <p>Controller disabled</p> <p>Heating/cooling</p> <p>Controller inactivated</p> <p>Frost alarm</p>	<p>Determines the controller status to be transmitted.</p> <p>Only if „status indication of controller“ = „transmit individual state“!</p>

**Push button 2, 3, 5gang with room thermostat (RTR) and display flush-mounted**  
**756627xx, 756637xx, 756657xx**

Parameters		
Description:	Values:	Remarks:
 Room temperature regulator function – room temperature timer		
Room temperature timer	On Off	Enables the room temperature timer.
Lock room temperature timer via object	Yes No	The disable function can suppress the timer's switching programmes via the bus. Enables the disable function and the „ <i>disabling room-temperature-timer</i> “ object 55. The disable function of the heating timer is not enabled.
Polarity of blocking object	inverted (disable = 0) Not inverted (disable = 1)	Determines the polarity of the timer's disable object. Only if „Lock room temperature timer via object = „yes“!

Parameters		
Description:	Values:	Remarks:
 Scene function		
Data type Output 1	<b>Switching</b> Value Shutter/blind position	Determines the data type for the scene output.
Value type	<b>0...100 %</b> 0...255	Defines the value type for 1-byte scene objects. Depending on this setting it is possible to enter percentage values or dimensionless values for the scene commands. Only if „data type“ = „value“!
Data type Output 2 to 8	See data type output 1!	

**Push button 2, 3, 5gang with room thermostat (RTR) and display flush-mounted**  
**756627xx, 756637xx, 756657xx**

Parameters		
Description:	Values:	Remarks:
 Scene function – [1] Scene 1		
Name	[Text], <b>Scene 1</b>	A description for the internal scene can be entered at this point. This description is used exclusively for a better orientation in the ETS plug-in and will not be downloaded into the device.
Transmit output signal	Yes <b>No</b>	It is possible to determine – when recalling a scene – whether a scene command is to be transmitted via the selected scene output.
Value	<b>On</b> Off	Defines the switching value, which is transmitted on the bus during a scene recall.  Only if „transmit output signal = yes“ and „data type = switching“!
Value (0...100) * 1 %	0 to 100 %, <b>0 %</b>	Defines the value, which is transmitted on the bus during a scene recall.  Only if „transmit output signal = yes“ and „data type = value“ and „value type = 0...100 %“!
Value (0...255)	0 ... 255, <b>0</b>	Defines the value, which is transmitted on the bus during a scene recall.  Only if „transmit output signal = yes“ and „data type = value“ and „value type = 0...255“!
Shutter/blind position (0...100) * 1 % (0 => up)	0 to 100 %, <b>0 %</b>	Defines the shutter position value, which is transmitted on the bus during a scene recall.  Only if „transmit output signal = yes“ and „data type = shutter/blind position“!

Parameters		
Description:	Values:	Remarks:
 Scene function – [X] Scene X, X = 2 to 8 see scene 1!		

**Push button 2, 3, 5gang with room thermostat (RTR) and display flush-mounted**  
**756627xx, 756637xx, 756657xx**

Parameters		
Description:	Values:	Remarks:
 Controller extension function – room temperature measuring (FA)		
Temperature detection	<p><b>Internal sensor</b></p> <p>Internal and external sensor</p>	<p>Determines which sensor will be used for the room temperature measurement on the controller extension.</p> <p>Internal sensor: Sensor installed inside the push button RTR.</p> <p>Internal and external sensor: Both sensors are used, for example, in large rooms.</p>
Creating of measuring value internal against external	<p>10 % to 90 %</p> <p>20 % to 80 %</p> <p>30 % to 70 %</p> <p>40 % to 60 %</p> <p><b>50 % to 50 %</b></p> <p>60 % to 40 %</p> <p>70 % to 30 %</p> <p>80 % to 20 %</p> <p>90 % to 10 %</p>	<p>Determines the weighting of the measured temperature value for the internal and external sensors.</p> <p>That results in an overall value, which will be used for the further interpretation of the room temperature.</p> <p>Only if „temperature detection = internal and external sensor“!</p>
Adjustment internal sensor (-128...127) * 0.1 K	-128 ... 127, <b>0</b>	<p>Determines the value by which the internal sensor's room temperature value is calibrated.</p> <p>Only if „temperature detection = internal sensor“ or „internal and external sensor“ or in case of two control circuits!</p>
Adjustment external sensor (-128...127) * 0.1 K	-128 ... 127, <b>0</b>	<p>Determines the value by which the external sensor's room temperature value is calibrated.</p> <p>Only if „temperature detection“ = „internal and external sensor“!</p>
Scanning time for external sensor (0...255) * 1 min; 0 = inactive	0 ... 255, <b>0</b>	<p>Determines the measurement period for the external sensor's temperature value.</p> <p>"0" = sensor automatically transmits its temperature value.</p> <p>Only if „temperature detection“ = „internal and external sensor“!</p>
Transmission at room temperature modification by (0..255) * 0.1 K; 0 = no automatic transmission	0 ... 255, <b>3</b>	<p>Determines the size of the value change of the room temperature after which the current values are automatically transmitted on the bus via the „actual temperature“ object 23.</p>
Cyclical transmission of room temperature (0...255) * 1 min; 0 = inactive	0 ... 255, <b>15</b>	<p>Determines whether or when the determined room temperature of the first control circuit is to be periodically output via the „actual temperature“ object 23.</p>

**Push button 2, 3, 5gang with room thermostat (RTR) and display flush-mounted**  
**756627xx, 756637xx, 756657xx**

Send temperature alarm via object	<b>No</b> Yes	This parameter enables the „temperature alarm“ function if set to „yes“.
Lower temperature limit value (0...40 °C)	0...40 °C; <b>7 °C</b>	Lower temperature value for temperature alarm. Only if „Send temperature alarm via object“ = „yes“!
Upper temperature limit value (0...40 °C)	0...40 °C; <b>35 °C</b>	Upper temperature value for temperature alarm. Only if „Send temperature alarm via object“ = „yes“!

#### Software information

- **Parameter access**

In order to be able to set all the push button's parameters, the access must be set to „high access“ in the ETS plug-in! In order to set the type of access the „high access“ menu item in the „configuration“ menu has to be selected or deselected.

- **Dimming function (push button functions)**

For the status-LED to function properly for the status indication the connected dimming actuator has to transmit back its status to the switching object (push button function) or to the status object (rocker function) (set „transmit“ flag on actuator).

In order to function properly when using the push button function (brighter / darker (TOGGLE)) the connected dimming actuator must also transmit back its status to the switching object.

With push button or rocker function only the switching object is tracked internally and externally. The dimming object (direction) will only internally be tracked so that – when using extensions (2 or more push buttons reduce/increase brightness of one lamp) – the direction (+/-) is not always switched-over on pressing the push button again.

The two-surface control (push button function) requires the objects of the associated push buttons to be assigned the same group address.

- **Value transmitter function (push button functions)**

When adjusting a value via a long operation the newly set values will be stored in RAM only, i.e. these values will be replaced by the preset values – originally programmed via the ETS – following a voltage failure or bus reset.

- **Status indication (push button functions)**

The status-LED (status indication) indicates the current status of the switching object (push button function). If a push button is actuated (e.g. ON) and if the push button does not get a positive acknowledgement (IACK) from an addressed actuator, the object status is updated and the corresponding status-LED lights up.

- **System requirements for the ETS plug-in**

Operating system: Windows 9x, ME, Nt 4.0, 2000, XP

ETS: ETS2 v 1.2 a or higher, recommended from ETS 3.0c

PC: recommended Pentium I-Processor (or similar), 166 MHz, 32 MB or higher

- **ETS functions**

The „Device info“ or the „Device memory viewer“ ETS functions are not available for the push button RTR.

Executing the „shrink database“ ETS function will lead to a corruption of project data on the push button RTR, if the ETS 2 (including version v 1.3.) is used - which should absolutely be avoided! The ServiceRelease „a“ for the ETS2 v 1.3 should be installed to remedy the problem!

# Push button 2, 3, 5gang with room thermostat (RTR) and display flush-mounted 756627xx, 756637xx, 756657xx

## • Firmware

The push button with RTR and display allows to update user software in the device. The ETS plug-in allows the download of firmware by loading the data into the user module via the bus. This way even older push buttons may be updated in the future without having to exchange the device. Only the push button with RTR and display software in the ETS must be current. Basically, a download of the firmware becomes necessary only if an old device is to be updated!

'Normal' programming operations do not require the transmission of firmware.

The firmware in the push button is already preprogrammed for the initial operation.

A firmware download takes several minutes. The „**Fd**„ (Fd = firmware download) message appears on the display during the download of firmware.

If a download of firmware is required, the „options“ menu item in the „setting“ menu of the ETS plug-in must be opened. The options dialog box appears. The following parameter can be set on the „hardware“ tab.

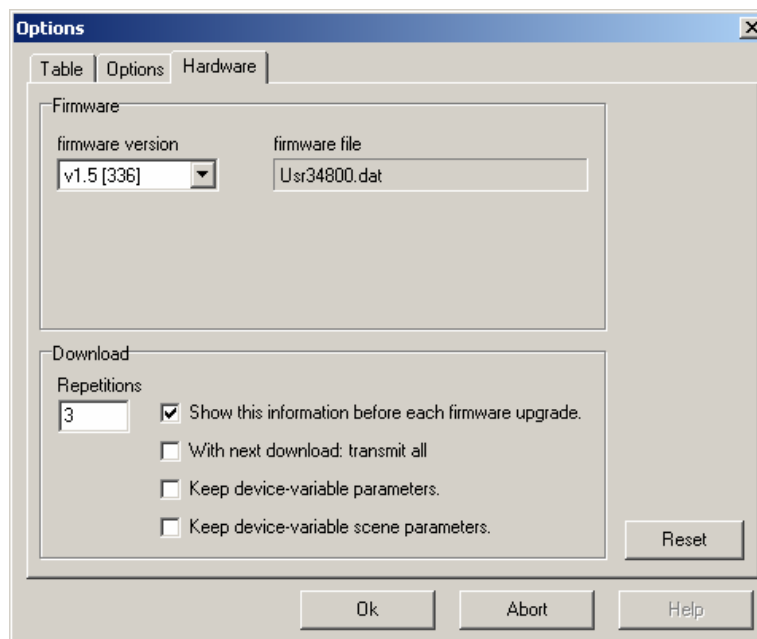

- Firmware version: This box lists all firmware versions known to the software. The most current version (highest number) should be selected. In the future, new software versions will be made available via a separate software update.
- Before a programming operation the software automatically detects whether the firmware installed in the device corresponds to the given software version. If this is not the case, a dialog box will pop up offering an upgrade or downgrade. By deselecting the „Show this information before each firmware upgrade“ checkbox, this message will not be shown again even when programming other push buttons with non-compatible firmware. It is possible to reactivate the checkbox anytime via the options dialog.
- The download of the firmware is started together with the application download. In order to have the firmware loaded into the device during the next programming operation, the „With next download transmit all“ checkbox must be selected.
- If the „Keep device-variable parameters“ checkbox is selected, the temperature setpoints (decrease/increase standby / night, Dead band, basic setpoint) of the first control circuit, which can be changed locally on the device or via the bus, will (during a download) not be replaced by the values parameterized in the ETS plug-in. If the „Keep device-variable scene parameters“ checkbox is selected, the scene values, which are stored locally on the device, will not be replaced – during a download- by the values parameterized in the ETS plug-in. If the push button is programmed for the first time after including it into the ETS project, all parameters and scene values are definitely loaded into the target device even if the flags are set.