



Product documentation

Temperature controller fan coil
Art. no. TRDLS9248..

Temperature controller fan coil
Art. no. TRDA5248..

ALBRECHT JUNG GMBH & CO. KG
Volmestraße 1
58579 Schalksmühle
GERMANY

Telefon: +49 2355 806-0
Telefax: +49 2355 806-204
kundencenter@jung.de
www.jung.de

Issue: 08.01.2021
TD 1355882x v2

Table of Contents

1	Information on the product	4
1.1	Product catalogue	4
1.2	Function	4
1.3	Device components	5
1.4	Delivery state	6
1.5	Technical data.....	7
2	Safety instructions.....	8
3	Fitting and electrical connection.....	9
4	Commissioning.....	10
5	Application programs	12
6	Operation	13
6.1	Operating level.....	13
6.2	Menu level.....	18
7	Scope of functions.....	33
8	Notes on software	36
9	Functional description of the display	37
9.1	Displayed information	37
9.2	Display control	37
9.3	Display object table.....	38
9.4	Parameter group "General".....	39
9.5	"Display" parameter group.....	41
10	Functional description of the room temperature controller.....	47
10.1	Operating modes and operating mode change-over	47
10.2	Control algorithms and calculation of command values.....	49
10.3	Adapting the control algorithms	53
10.4	Operating mode switchover / profile switchover	55
10.4.1	Operating mode switchover ("KNX" controller mode).....	56
10.4.2	Profile switchover ("Hotel" controller mode)	62
10.5	Room temperature measurement.....	68
10.5.1	Parameter group "Room temperature measurement"	71
10.5.2	Object table, room temperature measurement.....	72
10.6	Temperature setpoints.....	73
10.7	Command value and status output	85
10.8	Fan controller	93

10.9	Disabling functions.....	102
10.10	Parameter group "Room temperature control (RTC)".....	102
10.11	Object table "room temperature controller".....	124
11	Functional description of the controller extension	139
11.1	Connection to room temperature controller	139
11.2	Operating functions.....	140
11.3	Display functions.....	144
11.4	Behaviour after a device restart.....	145
11.5	Parameter group "controller extension"	146
11.6	Object table "controller extension"	147
12	Functional description of the status LED.....	152
12.1	Object table "operation and actuation LED".....	153

1 Information on the product

1.1 Product catalogue

Product name:	Temperature controller fan coil / Temperature controller fan coil
Use:	Sensor
Design:	FM (flush-mounted)
Art.-no.	TRDLS9248.. / TRDA5248..

1.2 Function

The device operates electrical blower convectors in KNX systems. The functions of a KNX bus coupling unit, room temperature controller and display device are combined in just one KNX subscriber. The room temperature can be controlled centrally using the device.

The device possesses 8 sensor buttons. The integrated room temperature controller can be operated with the sensor buttons. The room temperature controller function can be configured in the ETS.

The room temperature controller can be used for single-room temperature control. Depending on the operating mode, current temperature setpoint and room temperature, a variable for heating or cooling control can be transmitted to the KNX for the control circuit.

For heating and cooling functions, you can select continuous or switching PI feedback control algorithms.

The controller can distinguish between four operating modes according to the KNX standard or 5 profiles for use in hotels or similar locations, each with their own temperature setpoints in heating or cooling mode.

The room temperature controller function can be configured to the function of a controller extension. The controller extension can fully control a room temperature controller and display the full status of the controller in the display.

The device can determine a room temperature on the device. Room temperature measurement can be performed by the internal sensor or, optionally, by an external sensor. Combined temperature recording (internal and external sensor) can also be configured.

The integrated display displays the actual temperature and the room temperature control statuses. The menu levels are shown on the display, providing that it has been enabled in the parameters. In the menu levels, it is also possible to change controller settings (setpoint temperatures, operating mode, fan control, etc) and the basic settings of the device (display brightness, display contrast, etc.) directly on the device.

The device possesses a status LED. The status LED has three colours (red, green or blue). The Status LED functions as a programming LED, operation LED and actuation LED.

With application program from version 1.2: Output of the control values heating and cooling for combined rotary valves with control via voltage values possible.

1.3 Device components

The devices can be integrated in the A, CD and LS series. Irrespective of the switch range, the same room temperature controller functions are made available.

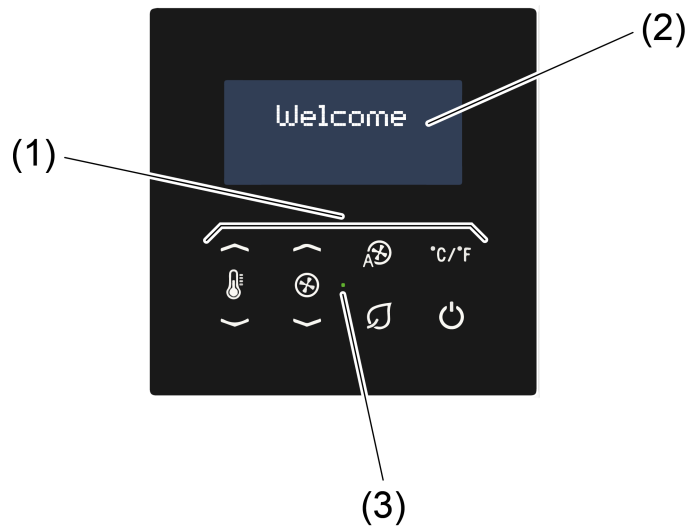

Image 1: Device view, front side

- (1) sensor buttons
- (2) Display
- (3) Status LED

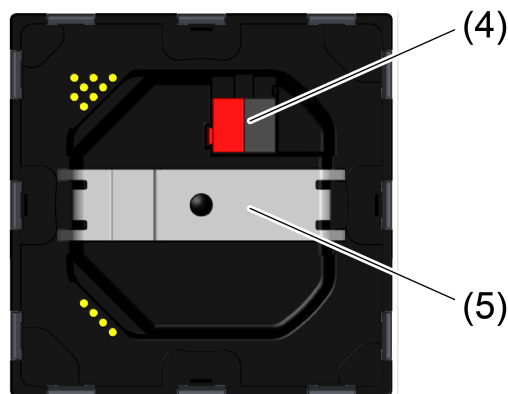

Image 2: Device view, rear side

- (4) Connection of KNX bus cable
- (5) Retaining spring

sensor buttons

The device possesses eight sensor buttons. The functions of the sensor buttons are permanently implemented.

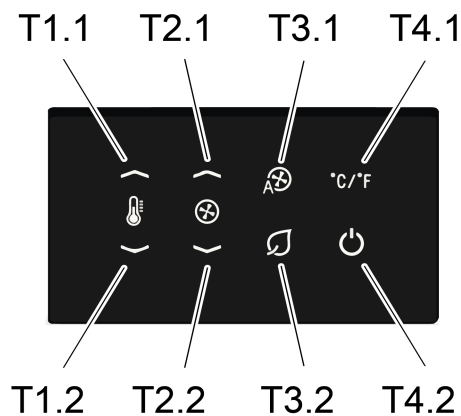

Image 3: sensor buttons

- T1.1 Setpoint shift of the temperature in the positive direction
- T1.2 Setpoint shift of the temperature in the negative direction
- T2.1 Activation of manual fan control and shift in the positive direction
- T2.2 Activation of manual fan control and shift in the negative direction
- T3.1 Activation of automatic fan control
- T3.2 Operating mode or profile switchover
- T4.1 Switchover of the temperature unit between °C and °F
- T4.2 Operating mode or profile switchover

1.4 Delivery state

The delivery state defines the functions of the device when it is connected to the KNX but has not been programmed with application data by the ETS or the application program was unloaded by the ETS.

This condition persists until the application is programmed into the device.

The display switches on for the period of 1 minute as soon as the device is supplied with bus voltage. The following information is shown in the device display:

- Article number
- Firmware of the display controller
- Firmware of the KNX controller
- Information text "NO APPLICATION"

Each actuation of a sensor button switches the display on for the period of 1 minute. Programming mode can be activated when the display is switched on (siehe Kapitel "Commissioning" ▶ Page 10).

The Status LED flashes blue with a frequency of approx. 0.75 Hz.

1.5 Technical data

General

Protection class	III
Test mark	KNX
Ambient temperature	-5 ... +45 °C
Storage/transport temperature	-25 ... +70 °C

KNX/EIB supply

KNX medium	TP256
Commissioning mode	S-mode
Rated voltage KNX	DC 21 ... 32 V SELV
Current consumption KNX	8 ... 17.5 mA

2 Safety instructions



Electrical devices may only be mounted and connected by electrically skilled persons.

Failure to observe the instructions may cause damage to the device and result in fire and other hazards.

Danger of electric shock. Make sure during the installation that there is always sufficient insulation between the mains voltage and the bus. A minimum distance of at least 4 mm must be maintained between bus conductors and mains voltage cores.

The device may not be opened or operated outside the technical specifications.

3 Fitting and electrical connection



DANGER!

Electrical shock on contact with live parts in the installation environment.

Electrical shocks can be fatal.

Before working on the device, disconnect the power supply and cover up live parts in the working environment.

Mounting and connecting the device

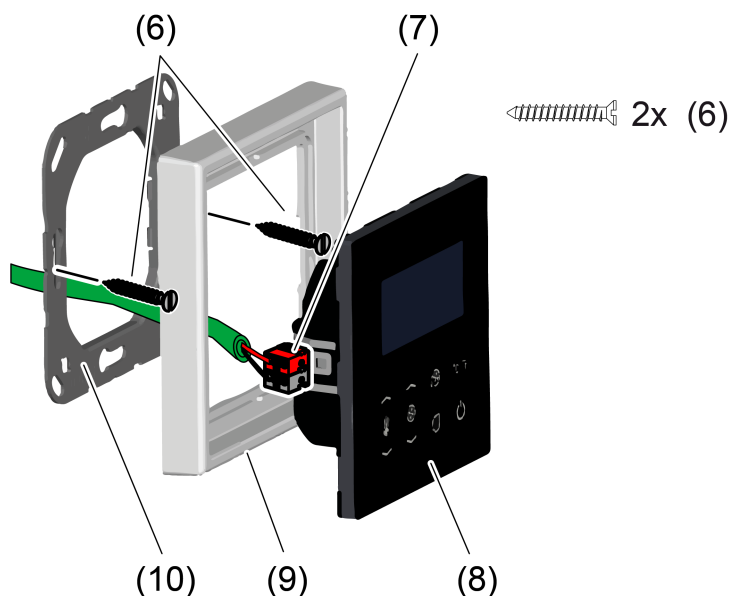

Image 4: Device fitting

- (6) Box screws
- (7) KNX connection terminal
- (8) Room temperature controller
- (9) Design frame
- (10) Supporting frame

i Recommended installation height: 1.50 m.

- Mount supporting frame (10) in the right orientation on an appliance box. Note the **TOP** marking. Use the enclosed box screws (6).
- Position the design frame (9) on the supporting frame.
- Connect the device (8) with KNX connection terminal (7), which is connected to the KNX bus line, to the rear side of the device. Run the connection cable downwards from the device and then into the appliance box from the rear.
- Attach the device onto the supporting frame (10).

4 Commissioning

After connection and mounting, the device can be commissioned. The commissioning is confined to the programming of the actuator via the ETS.

Programming the physical address

Precondition: For commissioning, the device must be connected and the bus voltage switched on.

- i** The device has no separate programming button or LED.
 - Activate Programming mode.
To do this, press the sensor buttons T1.1 and T4.2 for at least 2 seconds on the device (see figure 5)

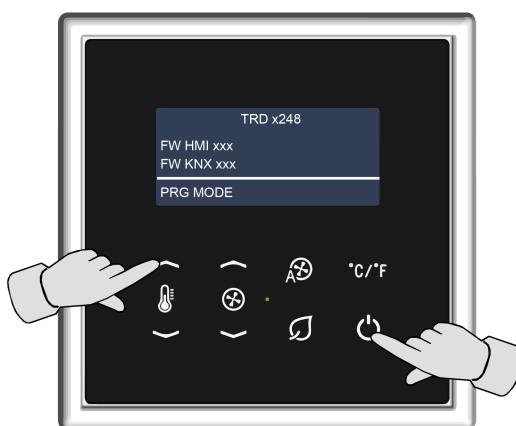

Image 5: Activating programming mode

Result: Programming mode is activated.

The status LED flashes blue at a frequency of approximately 4 Hz. An active programming mode is displayed by the text "PRG MODE".

- i** If the device is unloaded, does not contain an application program - or contains the wrong one - the text "NO APPLICATION" appears in the display. The status LED flashes blue with a frequency of about 0.75 Hz.
- i** To exclude any inadvertent activation of Programming mode during 'normal' use of the control surface in later operation, the actuation length of the two sensor buttons must be at least 2 s.
 - Program the physical address with the help of the ETS.
Result: The physical address is programmed.
Programming mode is exited automatically on application of the physical address.
 - Exiting programming mode manually:
 - By pressing any sensor button on the device
 - By pressing the button combination (T1.1 and T4.2) again on the device

- i** If Programming mode is to be activated or deactivated in a device which is already programmed with a valid application, there is the possibility that telegrams will be transmitted to the bus at the time the button is pressed.

Programming the application program

Program the application into the device with the help of the ETS. Commissioning using ETS5 or ETS4.2 is possible.

The ETS detects automatically whether a valid application has already been programmed into the device before. To reduce the programming time, the ETS downloads the whole application only if the device was programmed beforehand with another application or with no application at all. In all other cases, the ETS makes a time-optimised partial download in which only the modified data is loaded into the device.

5 Application programs

ETS search paths: Heating, A/C, Ventilation / Regulator / Temperature controller
 Heating, A/C, Ventilation / Regulator / Temperature controller

Configuration: S-mode standard

Applications:

Name Temperature controller fan coil 111111

Version: 1.1
 for ETS 4.2
 and ETS 5

from mask version SystemB
 (07B0)

Summarized de-
 scription Multifunctional room temperature controller application:
 8 sensor buttons for operation of the room temperature control-
 ler.

Name Temperature controller fan coil 111112

Version: 1.2
 for ETS 4.2
 and ETS 5

from mask version SystemB
 (07B0)

Summarized de-
 scription Multifunctional room temperature controller application:
 8 sensor buttons for operation of the room temperature control-
 ler.
 Setpoint shift via levels (DPT 6.010) and via offset (DPT 9.002)
 Conversion of the control variable output values into a control
 variable for a rotary actuator

6 Operation

The bottom half of the device is used for operation. The device possesses 8 sensor buttons in this area. All the functions of the operating level and the menu are operated using these sensor buttons. After a settable time without button actuation, the display switches off. The display switches on again after the first actuation of the sensor buttons. Simultaneous actuation of the sensor buttons T1.2 and T3.2 activates the menu level.

6.1 Operating level

In the operating level, a function is permanently assigned to each sensor button. The sensor buttons do not have their own communication objects. When actuated, the function of a sensor button has a direct or indirect effect on the function of the controller or the controller extension.

Sensor-button	Function of the sensor button in the operating level
T1.1	Setpoint shift of the temperature in the positive direction
T1.2	Setpoint shift of the temperature in the negative direction
T2.1	Activation of manual fan control and shift of the fan level in the positive direction
T2.2	Activation of manual fan control and shift of the fan level in the negative direction
T3.1	Activation of automatic fan control
T3.2	<p><u>Operating mode switchover ("KNX" controller mode) when presence exists</u> Switchover between the Night and Comfort operating modes</p> <p><u>Operating mode switchover ("KNX" controller mode) when no presence exists</u> Switchover between the Night and Standby operating modes</p> <p><u>Profile switchover ("Hotel" controller mode) when presence exists</u> Switchover between the "Eco" and "Comfort" profiles</p> <p><u>Profile switchover ("Hotel" controller mode) when no presence exists</u> Switchover between the "Eco" and "Comfort-" profiles</p>
T4.1	Switchover of the temperature unit between °C and °F
T4.2	<p><u>Operating mode switchover ("KNX" controller mode) when presence exists</u> Switchover between the Frost/heat protection and Comfort operating modes</p> <p><u>Operating mode switchover ("KNX" controller mode) when no presence exists</u> Switchover between the Frost/heat protection and Standby operating modes</p> <p><u>Profile switchover ("Hotel" controller mode) when presence exists</u> Switchover between the "Standby" and "Comfort" profiles</p>

Sensor-button	Function of the sensor button in the operating level
	Profile switchover ("Hotel" controller mode) when no presence exists Switchover between the "Standby" and "Comfort-" profiles

Functions of the sensor buttons in the operating level

The sensor buttons T1.1 and T1.2 shift the temperature setpoint in the positive (∧) or in the negative (∨) direction.

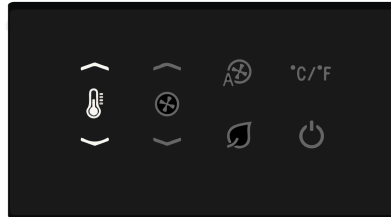

Image 6: Sensor buttons for the setpoint shift

In a setpoint shift, the basic temperature setpoint is moved one step in the positive or negative direction by the configured "Value of the setpoint shift" when a sensor button is pressed. The "Value of the setpoint shift" is configured in °C or °F, depending on the "Basic temperature unit setting". The maximum "Upward adjustment of the basic setpoint temperature" and the maximum "Downward adjustment of the basic setpoint temperature" are dependent on the "Setpoint shift value". The basic setpoint temperature can be shifted in this area.

"Value of the setpoint shift"	Possible "Adjustment of the basic setpoint temperature"
0.5 K	+ 5 K upwards - 5 K downwards
1.0 K	+ 10 K upwards - 10 K downwards
1.5 K	+ 11 K upwards - 11 K downwards
2.0 K	+ 10 K upwards - 10 K downwards

Possible "Adjustment of the basic setpoint temperature" according to the "Value of the setpoint shift" (basic temperature unit setting = ° Celsius)

"Value of the setpoint shift"	Possible "Adjustment of the basic setpoint temperature"
1 °F	+ 6 K upwards - 6 K downwards
2 °F	+ 12 K upwards - 12 K downwards
3 °F	+ 12 K upwards - 12 K downwards

"Value of the setpoint shift"	Possible "Adjustment of the basic setpoint temperature"
4 °F	+ 12 K upwards - 12 K downwards

Possible "Adjustment of the basic setpoint temperature" according to the "Value of the setpoint shift" (basic temperature unit setting = ° Fahrenheit)

After a setpoint shift, the device transmits the current "Setpoint temperature" and the "Current setpoint shift" value to the bus via communication objects.

Each adjustment causes the display to change temporarily. The current setpoint is displayed for a period of 4 seconds.

- i** Differences between the configuration of the "Basic temperature unit setting" parameter and the setting on the device using the sensor button T4.1 (unit of the displayed temperature values) cause different step widths due to rounding differences.
- i** Further information on the setpoint shift appears further on in this product documentation (siehe Kapitel "Temperature setpoints" ▶ Page 73).

The sensor buttons T2.1 and T2.2 activate manual fan control and adjust the fan level upwards (∧) and downwards (∨) .

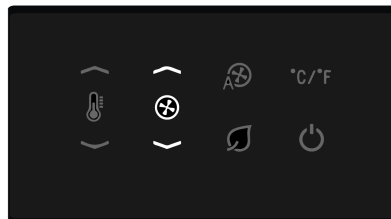

Image 7: Sensor buttons for manual fan control

Each adjustment causes the display to change temporarily. The fan levels icon is displayed for a period of 4 seconds. The number of filled bars represents the set fan level.



Image 8: Setting of manual fan control (operating level)

The parameter "Number of fan levels" sets the actually used number of levels (1...3). Adjustment of fan levels can only take place on actually used fan levels. With a configured number of, for example, 2 levels, the adjustment of the fan levels can only take place up to fan level 2.

- i** Further information on fan control appears further on in this product documentation (siehe Kapitel "Fan controller" ▶ Page 93).

Sensor button T3.1 activates automatic fan control.

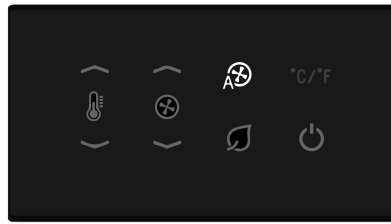

Image 9: Sensor button for activation of automatic fan control

i Further information on fan control appears further on in this product documentation (siehe Kapitel "Fan controller" ▶ Page 93).

In the display, the sensor button T4.1 toggles the unit of the displayed temperature values between °C and °F.

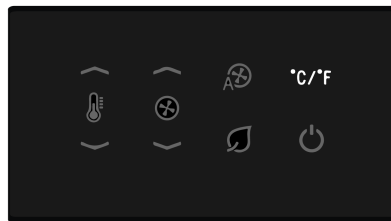

Image 10: Sensor button for toggling the unit of the temperature values

Sensor buttons T3.2 and T4.2 switch over the operating mode (KNX controller mode) and the profile (Hotel controller mode).

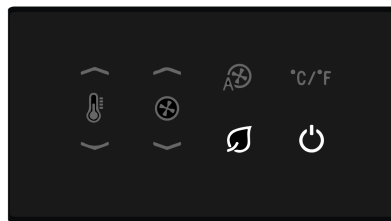

Image 11: Sensor buttons for toggling the operating mode or the profile

The operating mode switchover ("KNX" controller mode) or the profile switchover ("Hotel" controller mode) takes place according to the presence status.

Sensor-button	Motion status	Controller mode "KNX"	Controller mode "Hotel"
T3.2	Presence present	Switchover between the operating modes Night and Comfort mode	Switchover between the profiles "Eco" and "Comfort"
T3.2	Presence not present	Switchover between the operating modes Night and Standby	Switchover between the profiles "Eco" and "Comfort-"

Sensor-button	Motion status	Controller mode "KNX"	Controller mode "Hotel"
T4.2	Presence present	Switchover between the operating modes Frost/heat protection and Comfort mode	Switchover between the profiles "Standby" and "Comfort"
T4.2	Presence not present	Switchover between the operating modes Frost/heat protection and Standby	Switchover between the profiles "Standby" and "Comfort-"

Switchover of the operating modes and profiles according to the presence status

- i** The setting of the parameter "Presence permanently active" influences the presence detection of the room temperature controller. The presence status of the room temperature controller is permanently set to available if the parameter is set to "Yes". If the parameter is configured to "No", presence detection takes place via the "Presence detector" object.
- i** In the "KNX" controller mode, sensor buttons T3.2 and T4.2 switch over the operating mode and also affect the forced operating mode. If the operating modes "Night" or "Frost/heat protection" are recalled using the sensor buttons on the device, then the controller works in the forced operating mode. In consequence, the device no longer reacts to operating mode switchovers via the "Controller - Operating mode switchover input" object. For an object-guided operating mode switchover, the 1-byte object "Controller - Forced object operating mode input" must be written with the value "00" (auto (normal operating mode switchover) via the bus. An object-guided operating mode switchover is also possible if the "Standby" operating mode was recalled using the sensor buttons on the device.

The device then shows the actually set operating mode on the display. The actually set operating mode is transmitted to the bus via the "Currently active operating mode" object.

- i** The "KNX operating mode status" also sends its status to the bus after an operating mode switchover. Depending on the status of the presence, window and forced operating mode, the "KNX operating mode status" may deviate from the currently active operating mode.
- i** Further information on the operating mode switchover appears further on in this product documentation (siehe Kapitel "Operating mode switchover ("KNX" controller mode)" ▶ Page 56).
- i** Further information on the profile switchover appears further on in this product documentation (siehe Kapitel "Profile switchover ("Hotel" controller mode)" ▶ Page 62).

6.2 Menu level

Depending on the configuration in the ETS, the device possesses two menu levels. The menu levels can be recalled on the device when they have been enabled on the parameter page "Display -> Display general".

In menu level 1, it is possible to switch over manually between the Heating and Cooling operating modes.

Menu level 2 makes it possible to make various basic settings on the device and room temperature controller locally without using the ETS. Menu level 2 is subdivided into the menu item groups "Continuous controller", "Fan control" and "Device configuration".

- i** Access to individual settings or to the entire menu level 2 can be prevented via the configuration in the ETS. This prevents the unintentional disruption of essential functions.

Recalling menu levels

The menu levels are recalled by pressing sensor buttons T1.2 and T3.2 on the device simultaneously and keeping them held down for a specific period(see figure 12).

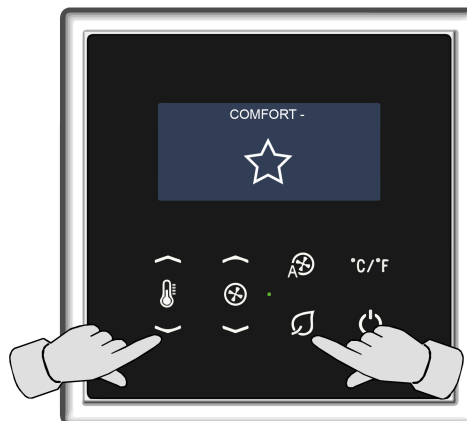

Image 12: Recalling the menu level

Menu level	Actuation length
Menu level 1	> 2 seconds
Menu level 2	> 5 seconds

Actuation period of the sensor buttons T1.2 and T3.2 for recalling the menu levels

Menu level 1 is available with the following parameter settings:

- Menu levels = Enabled
- Room temperature controller function = Switched on
- Operating mode = Heating and cooling
- Switchover between heating and cooling = Via object (heating/cooling switchover)

Menu level 2 is available with the following parameter settings:

- Menu level = Enabled

- i** If menu items are configured as "hidden", they do not appear in the menu level. This setting is performed in the ETS separately for various menu items in the parameter node "Display -> Display general -> Menu level".
- i** Some menu items are always visible and can thus not be configured as invisible in the ETS.
- i** When the device functions as a controller extension, controller settings (setpoint temperatures, setpoint shifting, fan control) are fundamentally not accessible in the menu level.

Exiting the menu level

The menu level can be exited manually with saving, manually without saving or automatically.

- i** If the menu level is exited manually without saving or automatically, the changes are lost. The device continues to work with the basic settings which it had before the menu level was recalled.
- i** If the programming mode of the device is activated when the menu level is recalled, then the menu level is exited without saving the changes.

Sensor button T4.1 saves the changes and then exits the menu level.

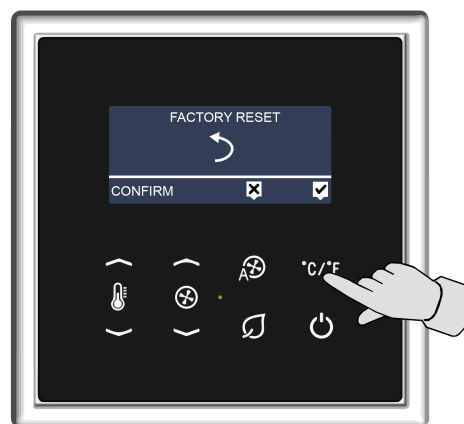

Image 13: Exit the menu level manually with saving

Sensor button T3.1 exits the menu level without saving the changes.

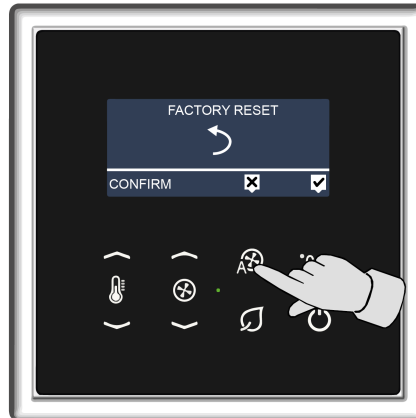

Image 14: Exit the menu level manually without saving

The menu level is exited automatically when the display is switched off. The device does not save the changes. On automatic exiting of menu level 1, the device exits the menu level without warning when the device is switched off. Before menu level 2 is exited, the device signals 10 seconds before the display is switched off that the changes should be confirmed. In addition, a countdown runs in the display before the device rejects the changes and the display switches off. Whilst the 10 seconds are counting down, the local operator has the option of exiting the menu level manually. In so doing, they can save the changes (see figure 13) or not (see figure 14).

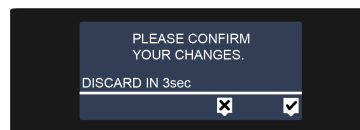

Image 15: Information message before switching off the display

If no selection is made within the 10 seconds, then the menu level is exited when the display switches off automatically, without saving the changes.

Operation in the menu level

The settings in the menu level are organised in a menu. The menu items can be recalled and configured using the sensor buttons. This is shown in the display.

i The sensor buttons have a different function in the menu level than in the operating level.

Sensor button	Function of the sensor button in the menu level
T1.1	Move menu value in the positive direction or to the right
T1.2	Move menu value in the negative direction or to the left
T2.1	Recall previous menu item
T2.2	Recall next menu item
T3.1	Exit the menu level without saving changes
T3.2	No function
T4.1	Exit the menu level, saving changes

Sensor button	Function of the sensor button in the menu level
T4.2	No function

Functions of the sensor buttons in the menu level

- i** Continuous adjustment of the value settings is possible if the sensor buttons are held down.

Menu level 1

In menu level 1, it is possible to switch between the Heating and Cooling operating modes, providing that the menu levels have been enabled, the room temperature controller is working in the "Heating and cooling" operating mode and the switchover between heating and cooling takes place via an object.

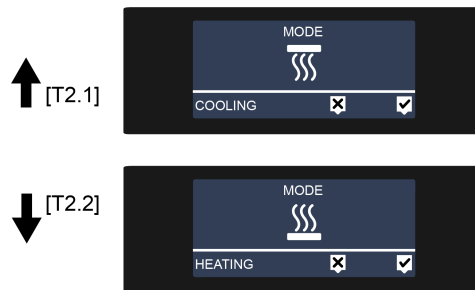

Image 16: Menu level 1: Switchover between heating and cooling

Menu level 2

The menu level 2 makes it possible to make various basic settings on the unit locally without using the ETS. Access to individual settings or to the entire menu level can be prevented via the configuration in the ETS. This prevents the unintentional disruption of essential functions. Menu level 2 is subdivided into the menu item groups "Continuous controller", "Fan control" and "Device configuration". Depending on the designed controller mode, the following basic settings can be configured in menu level 2:

Configurable basic setting	"KNX" controller mode	"Hotel" controller mode
Setpoint temperature, heating	"Comfort mode" operating mode	"Comfort" profile
Setpoint temperature, cooling	"Comfort mode" operating mode	"Comfort" profile
Setpoint temperature reduction	"Standby" operating mode	"Comfort-" profile
Setpoint temperature increase	"Standby" operating mode	"Comfort-" profile
Fan control setting	"Standby" operating mode	"Comfort-" profile
Setpoint temperature reduction	"Night" operating mode	"Eco" profile

Configurable basic setting	"KNX" controller mode	"Hotel" controller mode
Setpoint temperature increase	"Night" operating mode	"Eco" profile
Fan control setting	"Night" operating mode	"Eco" profile
Setpoint temperature reduction	not available	"Standby" profile
Setpoint temperature increase	not available	"Standby" profile
Fan control setting	not available	"Standby" profile
Setting, temperature measurement offset	Available	Available
Reset to default settings	Available	Available
Disable controller	Available	Available
Setting, display brightness	Available	Available
Setting, display contrast	Available	Available
Setting, display illumination period	Available	Available

Configurable basic settings in menu level 2

Setting the heating setpoint temperature:

This menu item of menu level 2 configures the setpoint temperature of the "Heating" operating mode for:

- Comfort mode in the "KNX" controller mode or
- The "Comfort" profile in the "Hotel" controller mode.

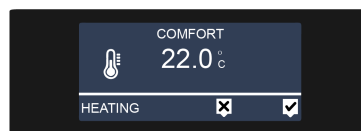

Image 17: Setting the heating setpoint temperature (menu level 2)

The sensor buttons T1.1 and T1.2 can be used to adjust the setpoint temperature in a step width of +/- 0.5 K. The setpoint temperature is displayed flashing as an absolute value in °C or °F.

The menu entry "Setpoint temperature change" is visible as an option as a component of the "Continuous controller" menu item group.

i This menu is not accessible in controller extensions.

This menu item of menu level 2 is available with the following parameter settings:

- Menu levels = Enabled
- Continuous controller menu item group = Visible
- Change setpoint temperature, heating comfort mode = Visible or
Change setpoint temperature "Comfort" profile, heating = Visible
- Room temperature controller function = Switched on
- Operating mode = Heating, Heating and cooling

Setting the cooling setpoint temperature:

This menu item of menu level 2 configures the setpoint temperature of the "Cooling" operating mode for:

- Comfort mode in the "KNX" controller mode or
- The "Comfort" profile in the "Hotel" controller mode.

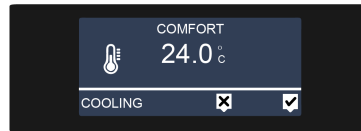

Image 18: Setting the cooling setpoint temperature (menu level 2)

The sensor buttons T1.1 and T1.2 can be used to adjust the setpoint temperature in a step width of +/- 0.5 K. The setpoint temperature is displayed flashing as an absolute value in °C or °F.

The menu entry "Setpoint temperature change" is visible as an option as a component of the "Continuous controller" menu item group.

i This menu is not accessible in controller extensions.

This menu item of menu level 2 is available with the following parameter settings:

- Menu levels = Enabled
- Continuous controller menu item group = Visible
- Change setpoint temperature, cooling comfort mode = Visible or
Change setpoint temperature "Comfort" profile, cooling = Visible
- Room temperature controller function = Switched on
- Operating mode = Cooling, Heating and cooling

Setpoint temperature reduction (COMFORT-):

This menu item of menu level 2 configures the reduction of the setpoint temperature of the "Heating" operating mode for:

- Standby mode in the "KNX" controller mode or
- The "Comfort-" profile in the "Hotel" controller mode.



Image 19: Increasing the heating setpoint temperature (menu level 2)

The sensor buttons T1.1 and T1.2 can be used to shift the setpoint temperature in a step width of +/- 0.5 K. The value by which setpoint temperature is shifted, is displayed flashing as an absolute value in K.

The menu entry "Change reduction" is visible as an option as a component of the "Continuous controller" menu item group.

i This menu is not accessible in controller extensions.

This menu item of menu level 2 is available with the following parameter settings:

- Menu levels = Enabled
- Continuous controller menu item group = Visible
- Change, reduction for standby mode, heating = Visible or
Change, reduction "Comfort-" profile, heating = Visible
- Room temperature controller function = Switched on
- Operating mode = Heating, Heating and cooling

Setpoint temperature increase (COMFORT-):

This menu item of menu level 2 configures the increase in the setpoint temperature of the "Cooling" operating mode for:

- Standby mode in the "KNX" controller mode or
- The "Comfort-" profile in the "Hotel" controller mode.



Image 20: Increasing the heating setpoint temperature (menu level 2)

The sensor buttons T1.1 and T1.2 can be used to shift the setpoint temperature in a step width of +/- 0.5 K. The value by which setpoint temperature is shifted, is displayed flashing as an absolute value in K.

The menu entry "Change increase" is visible as an option as a component of the "Continuous controller" menu item group.

i This menu is not accessible in controller extensions.

This menu item of menu level 2 is available with the following parameter settings:

- Menu levels = Enabled
- Continuous controller menu item group = Visible
- Change, increase for standby mode, cooling = Visible or
Change, increase "Comfort-" profile, cooling = Visible
- Room temperature controller function = Switched on
- Operating mode = Cooling, Heating and cooling

Fan control setting (COMFORT-):

This menu item of menu level 2 configures the fan control for:

- Standby mode in the "KNX" controller mode or
- The "Comfort-" profile in the "Hotel" controller mode.



Image 21: Fan control setting (menu level 2)

The sensor buttons T1.1 and T1.2 can be used to set fan control.

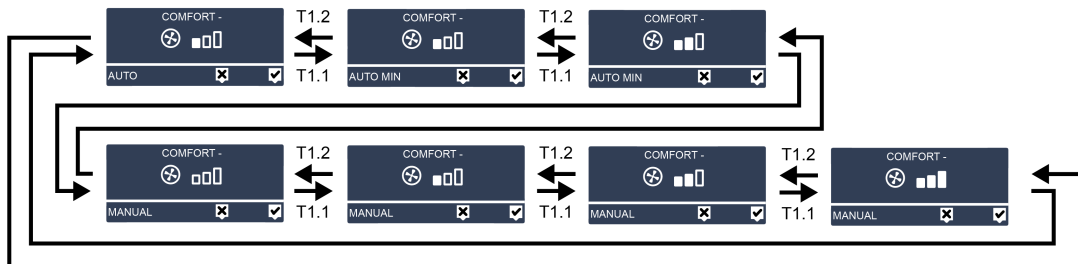

Image 22: Fan control setting options (Menu level 2)

i This menu is not accessible in controller extensions.

This menu item of menu level 2 is available with the following parameter settings:

- Menu levels = Enabled
- Fan control menu item group = Visible
- Change for Fan control standby mode = Visible or Change, Fan control, "Comfort-" profile = Visible
- Room temperature controller function = Switched on

Setpoint temperature reduction (ECO):

This menu item of menu level 2 configures the reduction of the setpoint temperature of the "Heating" operating mode for:

- Night mode in the "KNX" controller mode or
- The "Eco" profile in the "Hotel" controller mode.



Image 23: Increasing the heating setpoint temperature (menu level 2)

The sensor buttons T1.1 and T1.2 can be used to shift the setpoint temperature in a step width of +/- 0.5 K. The value by which setpoint temperature is shifted, is displayed flashing as an absolute value in K.

The menu entry "Change reduction" is visible as an option as a component of the "Continuous controller" menu item group.

i This menu is not accessible in controller extensions.

This menu item of menu level 2 is available with the following parameter settings:

- Menu levels = Enabled

- Continuous controller menu item group = Visible
- Change, reduction for night mode heating = Visible or
Change, reduction "Eco" profile, heating = Visible
- Room temperature controller function = Switched on
- Operating mode = Heating, Heating and cooling

Setpoint temperature increase (ECO):

This menu item of menu level 2 configures the increase in the setpoint temperature of the "Cooling" operating mode for:

- Night mode in the "KNX" controller mode or
- The "Eco" profile in the "Hotel" controller mode.

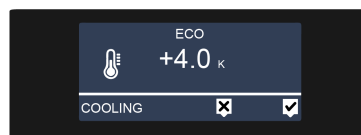

Image 24: Increasing the heating setpoint temperature (menu level 2)

The sensor buttons T1.1 and T1.2 can be used to shift the setpoint temperature in a step width of +/- 0.5 K. The value by which setpoint temperature is shifted, is displayed flashing as an absolute value in K.

The menu entry "Change increase" is visible as an option as a component of the "Continuous controller" menu item group.

i This menu is not accessible in controller extensions.

This menu item of menu level 2 is available with the following parameter settings:

- Menu levels = Enabled
- Continuous controller menu item group = Visible
- Change, increase for night mode, cooling = Visible or
Change, increase "Eco" profile, cooling = Visible
- Room temperature controller function = Switched on
- Operating mode = Cooling, Heating and cooling

Fan control setting (ECO):

This menu item of menu level 2 configures the fan control for:

- Night mode in the "KNX" controller mode or
- The "Eco" profile in the "Hotel" controller mode.



Image 25: Fan control setting (menu level 2)

The sensor buttons T1.1 and T1.2 can be used to set fan control.

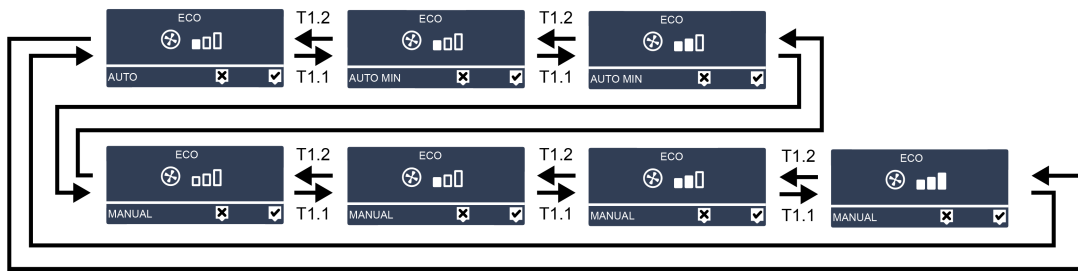

Image 26: Fan control setting options (Menu level 2)

i This menu is not accessible in controller extensions.

This menu item of menu level 2 is available with the following parameter settings:

- Menu levels = Enabled
- Fan control menu item group = Visible
- Change, Fan control night mode = Visible or
Change, Fan control, "Eco" profile = Visible
- Room temperature controller function = Switched on

Setpoint temperature reduction (STANDBY):

This menu item of menu level 2 configures the reduction of the setpoint temperature of the "Heating" operating mode for:

- The "Standby" profile in the "Hotel" controller mode.

i This menu item is contained in the "Hotel" controller mode. This menu item is not contained in the "KNX" controller mode.



Image 27: Increasing the heating setpoint temperature (menu level 2)

The sensor buttons T1.1 and T1.2 can be used to shift the setpoint temperature in a step width of +/- 0.5 K. The value by which setpoint temperature is shifted, is displayed flashing as an absolute value in K.

The menu entry "Change reduction" is visible as an option as a component of the "Continuous controller" menu item group.

i This menu is not accessible in controller extensions.

This menu item of menu level 2 is available with the following parameter settings:

- Menu levels = Enabled
- Continuous controller menu item group = Visible
- Change, reduction "Standby" profile, heating = Visible
- Room temperature controller function = Switched on
- Operating mode = Heating, Heating and cooling

Setpoint temperature increase (STANDBY):

This menu item of menu level 2 configures the increase in the setpoint temperature of the "Cooling" operating mode for:

- The "Standby" profile in the "Hotel" controller mode.

- i** This menu item is contained in the "Hotel" controller mode. This menu item is not contained in the "KNX" controller mode.



Image 28: Increasing the heating setpoint temperature (menu level 2)

The sensor buttons T1.1 and T1.2 can be used to shift the setpoint temperature in a step width of +/- 0.5 K. The value by which setpoint temperature is shifted, is displayed flashing as an absolute value in K.

The menu entry "Change increase" is visible as an option as a component of the "Continuous controller" menu item group.

- i** This menu is not accessible in controller extensions.

This menu item of menu level 2 is available with the following parameter settings:

- Menu levels = Enabled
- Continuous controller menu item group = Visible
- Change, increase "Standby" profile, cooling = Visible
- Room temperature controller function = Switched on
- Operating mode = Cooling, Heating and cooling

Fan control setting (STANDBY):

This menu item of menu level 2 configures the fan control for:

- The "Standby" profile in the "Hotel" controller mode.

- i** This menu item is contained in the "Hotel" controller mode. This menu item is not contained in the "KNX" controller mode.



Image 29: Fan control setting (menu level 2)

The sensor buttons T1.1 and T1.2 can be used to set fan control.

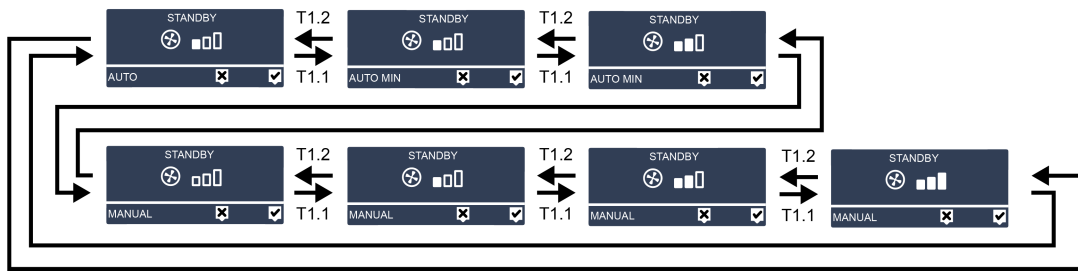

Image 30: Fan control setting options (Menu level 2)

i This menu is not accessible in controller extensions.

This menu item of menu level 2 is available with the following parameter settings:

- Menu levels = Enabled
- Fan control menu item group = Visible
- Change, Fan control, "Standby" profile = Visible
- Room temperature controller function = Switched on

Setting, temperature measurement offset:

This menu item of menu level 2 configures the temperature measurement offset.

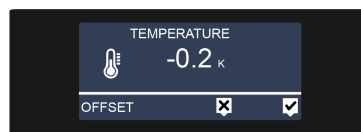

Image 31: Setting, temperature measurement offset (menu level 2)

The sensor buttons T1.1 and T1.2 can be used to adjust the temperature measurement offset in a step width of +/- 0.1 K. The offset shifts the actually measured temperature value of the internal sensor. The value by which the measured temperature value is shifted, is displayed flashing as an absolute value in K.

This menu item is visible as an option as a component of the "Device configuration" menu item group.

i This menu is not accessible in controller extensions.

i This setting influences temperature detection by the internal sensor, when it alone detects the temperature and when it detects the temperature in combination with the external sensor. If the temperature is detected by an external sensor, then the setting of this menu item has no effect.

i On reprogramming the application program, the temperature measurement offset configured in menu level 2 is overwritten by the values designed in the ETS parameters.

This menu item of menu level 2 is available with the following parameter settings:

- Menu levels = Enabled
- Menu item group Device configuration = Visible
- Temperature detection through = Internal sensor, internal and external sensor

Reset to default settings (factory reset):

This menu item of menu level 2 is used to reset all the values changed in menu level 2 to the original configuration of the device.



Image 32: Reset to default settings (menu level 2)

Confirming the factory reset resets the values of all the saved menu items to the last ETS configuration without a warning. In so doing, all the adjustments via the bus or using the menu items are rejected.

This menu item is visible as an option as a component of the "Device configuration" menu item group.

- i The reset to default settings has no influence on the Disable controller menu item.

This menu item of menu level 2 is available with the following parameter settings:

- Menu levels = Enabled
- Menu item group Device configuration = Visible

Disable controller:

This menu item of menu level 2 is used to disable the controller.



Image 33: Disable controller (Menu level 2)

This menu item is visible as an option as a component of the "Device configuration" menu item group.

- i This menu is not accessible in controller extensions.

This menu item of menu level 2 is available with the following parameter settings:

- Menu levels = Enabled
- Menu item group Device configuration = Visible
- Room temperature controller function = Switched on

Setting the display brightness:

This menu item of menu level 2 configures the display brightness.



Image 34: Setting the display brightness (Menu level 2)

The sensor buttons T1.1 and T1.2 can be used to adjust the display brightness in three levels.



Image 35: Setting options of the display brightness (Menu level 2)

This menu item of menu level 2 is available with the following parameter settings:

- Menu levels = Enabled
- Menu item group Device configuration = Visible

Setting the display contrast:

This menu item of menu level 2 configures the display contrast.



Image 36: Setting the display contrast (menu level 2)

The sensor buttons T1.1 and T1.2 can be used to adjust the display contrast in three levels.



Image 37: Setting options of the display contrast (menu level 2)

This menu item of menu level 2 is available with the following parameter settings:

- Menu levels = Enabled
- Menu item group Device configuration = Visible

Setting the display illumination period:

This menu item of menu level 2 configures the display illumination period.



Image 38: Setting the display illumination period (menu level 2)

The sensor buttons T1.1 and T1.2 can be used to adjust the display illumination period in a step width of +/- 1 s. The display illumination period can be configured between 15 s and 120 s. The time after which the display switches off is displayed as a flashing absolute value in **sec**.

This menu item is visible as an option as a component of the "Device configuration" menu item group.

This menu item of menu level 2 is available with the following parameter settings:

- Menu levels = Enabled
- Menu item group Device configuration = Visible

7 Scope of functions

Functions of the integrated room temperature controller

- The controller works in "KNX" controller mode or in "Hotel" controller mode.
- In "KNX" controller mode, the following operating modes can be activated: Comfort, Standby, Night and Frost/heat protection.
- In the "Hotel" controller mode, the following profiles can be activated: "Comfort", "Comfort-", "Eco", "Standby" and "Building Protection".
- Each operating mode or profile can be assigned its own temperature setpoints (for heating and/or cooling).
- Temperature setpoints are configured in relative form (derivation from the basic setpoint).
- Switchover of the operating modes or profiles via communication objects or sensor buttons.
- Frost/heat protection switchover via window status or by automatic frost protection ("KNX" controller mode).
- Building Protection switchover via window status or by automatic "Building Protection" ("Hotel" controller mode).
- The controller separates the operating modes "Heating" and "Cooling" into the individual operating mode or into mixed operation.
- In mixed operation, the controller can switch between "Heating" and "Cooling" automatically or according to objects.
- The control type (continuous PI control or switching PI control (PWM)) can be configured separately for heating and cooling.
- The control parameters (proportional range, reset time) for PI control can be set.
- A temporary or permanent setpoint shift through operation of the sensor buttons on the device or via communication objects is possible.
- Separate or shared command value output in heating and cooling mode. This makes one or two command value objects available.
- Normal or inverted command value output configurable.
- Automatic transmission and cycle time for actuating output configurable.
- Permanent command value limit or command value limit activatable via an object can be configured.
- Activation of an external fan using an automatic or manual fan control possible.
- Fan control can be set for each operating mode or for each profile, both for heating and for cooling.
- Limitation to maximum fan level can be configured.
- The actual and setpoint temperatures can be output on the bus if a configurable deviation is detected (also periodically).

- Setpoint temperature limit possible in cooling mode. If necessary, the controller limits the setpoint temperature to specific values and prevents an adjustment beyond statutory limits.
- Status feedback telegrams (also KNX compliant) can be configured.
- Sensor buttons for operation of the room temperature controller (setpoint shift, fan control, operating mode or profile switchover).
- Deactivating control possible using separate 1-bit object.
- With application program from version 1.2: Output of the control values heating and cooling for combined rotary valves with control via voltage values possible.

Functions of the integrated controller extension

- Alternatively to the function of the room temperature controller, the extension mode can be activated. This allows control of an external room temperature controller.
- Full control of the controller (operating mode or profile switchover and setpoint shift).
- Full-featured indication of the controller status on the display of the controller extension: Actual controller temperature, setpoint temperature, fan level, current operating mode or current profile, temperature unit °C/°F.
- Room temperature measurement is also possible on the controller extension.

Room temperature measurement functions

- Room temperature measurement possible via internal and/or external temperature sensor.
- Configurable internal to external determination of measured value and external sensor for room temperature measurement. Settable polling time of the external temperature sensor.
- The room temperature measurement (actual value) can be adjusted separately for the internal and external sensor using parameters.

Functions of the display

- The display brightness is adjustable in three levels.
- The display contrast is adjustable in three levels.
- The device can display temperatures in ° Celsius or in ° Fahrenheit.
- The display shows which operating mode ("KNX" controller mode) or which profile is set.
- The "Comfort" operating mode or profile displays the actual temperature and the status of the fan controller.

Functions of the status LED

- The Status LED can light up in red, green or blue.
- The Status LED functions as a programming LED, operation LED and actuation LED.
- If Programming mode is active, the Status LED flashes blue.

- The Status LED as an operation LED can be permanently on or off or alternatively be switched via a communication object. The operation LED lights up red or green according to the set operating mode ("KNX" controller mode) or profile ("Hotel" controller mode).
- The Status LED as an actuation LED can be permanently on or off or alternatively flash when a sensor button is pressed. Then, the actuation LED flashes for the period of actuation.

8 Notes on software

ETS project design and commissioning

Project design and commissioning of the device with the following ETS versions:

- ETS4.2
- ETS5 or higher

The necessary product database is offered in the *.knxprod format. No product database is available for ETS2, ETS3 and older versions of ETS4.

9 Functional description of the display

Introduction

The device possesses a display with switchable backlighting. On the display, icons signal various operating states of the integrated room temperature controller or the controller extension. In addition, the actual temperature is displayed. Simultaneous actuation of the sensor buttons T1.2 and T3.2 recalls the menu levels of the device. The content of the menu level 2 can be configured in the ETS.

9.1 Displayed information

Display icons

The table clarifies the meaning of all the display icons. The icons signal various states of the integrated room temperature controller or the controller extension.

Icon	Meaning
☆	Standby mode („KNX“ controller mode) or „Comfort-“ profile („Hotel“ controller mode)
🌙	Night mode („KNX“ controller mode) or „Eco“ profile („Hotel“ controller mode)
○	„Standby“ profile („Hotel“ controller mode)
❄️	Frost/heat protection mode („KNX“ controller mode) or „Building Protection“ profile („Hotel“ controller mode)
🌡️	Actual temperature or Setpoint temperature
🌀	Fan control, manuel operation
🌀Ⓐ	Fan control, automatic mode
□□□	Fan control, Fan OFF
■□□	Fan control, Fan level 1
■■□	Fan control, Fan level 2
■■■	Fan control, Fan level 3

Image 39: Meaning of the display icons

9.2 Display control

Display illumination

The display illumination is switched on as soon as a sensor button is pressed. From the actuation of the sensor button onwards, a device-internal switch-off time configured in the parameters of the ETS elapses. The switch-off time is retriggered by each actuation of a sensor button.

Switching on always takes place using the brightness level configured in the ETS, received via an object or most recently specified locally in the menu level.

In the case of activation by the value object, the display brightness is dimmed in accordance with the received value.

Display brightness	Object value
Level 1	1

Display brightness	Object value
Level 2	2
Level 3	3

Value meaning for 1-byte object "Display brightness"

- i** The brightness of the display can be set directly on the device in menu level 2 (siehe Kapitel "Menu level" ▶ Page 18) The brightness value set in the menu level is saved in the device in non-volatile memory, and overwrites the value last programmed using the ETS.
- i** In the un-programmed delivery state of the of the device or during a programming operation, the display brightness is preset to Level 2.

Display contrast

The display contrast can be changed in three levels in menu level 2 (siehe Kapitel "Menu level" ▶ Page 18) or in the parameters of the ETS.

- i** The contrast value set in the menu level is saved in the device in non-volatile memory, and overwrites the value last programmed using the ETS.
- i** In the un-programmed delivery state of the of the device, the display contrast is preset to Level 2.

9.3 Display object table

Function: Display brightness

Object no.	Function	Name	Type	DPT	Flag
6	Display brightness	Display - Input	1 bytes	5,010	C, (R), W, -, -

1-byte object for setting the display brightness in three levels.

Function: Display temperature display

Object no.	Function	Name	Type	DPT	Flag
13	Temperature display in °F	Display - Input/output	1-bit	1,001	C, R, W, T, A

1-bit object for switching over the unit of the displayed temperature values between °F and °C ("1" = °F; "0" = °C). This object is visible when the parameter "Basic setting, temperature unit" is set to "° Celsius".

Function: Display temperature display

Object no.	Function	Name	Type	DPT	Flag
13	Temperature display in °C	Display - Input/output	1-bit	1,001	C, R, W, T, A
<p>1-bit object for switching over the unit of the displayed temperature values between °F and °C ("1" = °C; "0" = °F). This object is visible when the parameter "Basic setting, temperature unit" is set to "° Fahrenheit".</p>					

9.4 Parameter group "General"

General

No parameters are shown on this parameter page. The "Basic settings" and "Room temperature measurement" parameter pages are subordinate to the "General" parameter page.

Basic settings

Basic setting, temperature unit	° Celsius ° Fahrenheit
<p>The display can show temperature values in the formats °C and °F. This parameter decides in which format temperature values are shown on the display. Room temperature control and room temperature measurement always take place with temperature values in the °C format. During operation, the basic setting of the temperature unit can be switched over using the sensor button T4.1. The device converts the received temperature values into °F, if °F values are to be displayed.</p>	

Room temperature controller function	Enabled Controller extension
<p>The room temperature controller function of the device can either work as a main controller or, alternatively, as a controller extension. The setting of this parameter has a major impact on the function of the device and on the other parameters and objects displayed in the ETS.</p> <p>switched-on: The device works as a main controller. The internal control algorithm is active, meaning that the device can be used for single-room temperature control.</p> <p>controller extension: The device works as a controller extension. A controller extension itself is not involved in the temperature regulating process. With it, the user can operate the single-room controller, i.e. the main controller from different places in the room. Any number of controller extensions can be controlled by a main controller.</p> <p>i In the function as a controller extension, settings relating to the integrated controller are not possible in the menu level.</p>	

Presence permanently active	Yes No
<p>The setting of this parameter influences the presence detection of the room temperature controller.</p> <p>Yes: Presence detection of the room temperature controller is deactivated. The presence status of the room temperature controller is permanently set to available. In this setting, the "Presence detector" object is not available.</p> <p>A normal operating mode switchover is only not possible in the "KNX" controller mode. The corresponding communication object is not available. A forced operating mode switchover is possible.</p> <p>No: Presence detection of the room temperature controller is activated. Presence detection takes place via the "Presence detector" object. With this object, it is possible to integrate presence detectors or hotel card switches into room temperature control.</p>	
Controller mode	KNX Hotel
<p>The controller can execute various modes.</p> <p>KNX: The controller or the controller extension work in "KNX" controller mode. In the "KNX" controller mode, the controller possesses the operating modes "Comfort mode", "Standby mode", "Night" and "Frost/heat protection".</p> <p>Hotel: The controller or the controller extension work in "Hotel" mode. In the "Hotel" controller mode, the controller possesses the profiles "Comfort", "Comfort-", "Eco", "Standby" and "Building Protection".</p>	
Function of operation LED	always off On Red or off Green or off Control via object
<p>The Status LED of the device can function as an operation LED and as an actuation LED. This parameter defines the function of the operation LED. The operation LED can be permanently on or off or alternatively be switched via a communication object. The operation LED lights up red or green according to the set operating mode ("KNX" controller mode) or profile ("Hotel" controller mode).</p>	
Activation via object of the operation LED	1 = On, 0 = Off 0 = On, 1 = Off
<p>If the "Function of the operation LED" is set to "Control via object", then the telegram polarity of the 1-bit object "Activate / deactivate operation LED" can be specified at this point.</p>	

Function of the actuation LED	always Off Flash on actuation
<p>The Status LED of the device can function as an operation LED and as an actuation LED. This parameter defines the function of the actuation LED. The actuation LED can be permanently on or off or alternatively flash when a sensor button is pressed. With "Flash on actuation", the actuation LED flashes for the period of actuation.</p>	

9.5 "Display" parameter group

Menu level 2

Continuous controller menu item group	Visible Hidden
<p>This parameter makes the menu item group Continuous controller in menu level 2 visible or invisible. Menu item groups summarise menu entries. If a menu item group is made invisible, then the assigned menu entries can no longer be recalled.</p> <p>i Depending on the configured controller mode ("KNX" or "Hotel"), the ETS makes additional entries available.</p>	

Change setpoint temperature, heating comfort mode	Visible Hidden
<p>This parameter makes the menu item "Change setpoint temperature, heating comfort mode" in menu level 2 visible or invisible. This menu item is assigned to the menu item group Continuous controller in menu level 2. If the Continuous controller menu item group is made invisible, then this menu entry can also no longer be recalled. This parameter is only visible when the controller mode is configured as "KNX".</p>	

Change, lowering for standby mode, heating	Visible Hidden
<p>This parameter makes the menu item "Change, lowering for standby mode, heating" in menu level 2 visible or invisible. This menu item is assigned to the menu item group Continuous controller in menu level 2. If the Continuous controller menu item group is made invisible, then this menu entry can also no longer be recalled. This parameter is only visible when the controller mode is configured as "KNX".</p>	

Change, lowering for night mode heating	Visible Hidden
<p>This parameter makes the menu item "Change, lowering for night mode, heating" in menu level 2 visible or invisible. This menu item is assigned to the menu item group Continuous controller in menu level 2. If the Continuous controller menu item group is made invisible, then this menu entry can also no longer be recalled. This parameter is only visible when the controller mode is configured as "KNX".</p>	

Chan. setpoint temp. during comfort mode, cooling	Visible Hidden
<p>This parameter makes the menu item "Change setpoint temperature, cooling comfort mode" in menu level 2 visible or invisible. This menu item is assigned to the menu item group Continuous controller in menu level 2. If the Continuous controller menu item group is made invisible, then this menu entry can also no longer be recalled. This parameter is only visible when the controller mode is configured as "KNX".</p>	
Change, raising for standby mode, cooling	Visible Hidden
<p>This parameter makes the menu item "Change, raising for standby mode, cooling" in menu level 2 visible or invisible. This menu item is assigned to the menu item group Continuous controller in menu level 2. If the Continuous controller menu item group is made invisible, then this menu entry can also no longer be recalled. This parameter is only visible when the controller mode is configured as "KNX".</p>	
Change, raising for night mode heating	Visible Hidden
<p>This parameter makes the menu item "Change, raising for night mode, cooling" in menu level 2 visible or invisible. This menu item is assigned to the menu item group Continuous controller in menu level 2. If the Continuous controller menu item group is made invisible, then this menu entry can also no longer be recalled. This parameter is only visible when the controller mode is configured as "KNX".</p>	
Change setpoint temperature "Comfort" profile, heating	Visible Hidden
<p>This parameter makes the menu item "Change setpoint temperature, heating comfort mode" in menu level 2 visible or invisible. This menu item is assigned to the menu item group Continuous controller in menu level 2. If the Continuous controller menu item group is made invisible, then this menu entry can also no longer be recalled. This parameter is only visible when the controller mode is configured as "Hotel".</p>	
Change, reduction "Comfort-" profile, heating	Visible Hidden
<p>This parameter makes the menu item "Change, lowering for "Comfort-" profile, heating" in menu level 2 visible or invisible. This menu item is assigned to the menu item group Continuous controller in menu level 2. If the Continuous controller menu item group is made invisible, then this menu entry can also no longer be recalled. This parameter is only visible when the controller mode is configured as "Hotel".</p>	

Change, reduction "Eco" profile, heating	Visible Hidden
<p>This parameter makes the menu item "Change, lowering for "Eco" profile, heating" in menu level 2 visible or invisible. This menu item is assigned to the menu item group Continuous controller in menu level 2. If the Continuous controller menu item group is made invisible, then this menu entry can also no longer be recalled. This parameter is only visible when the controller mode is configured as "Hotel".</p>	
Change, reduction "Standby" profile, heating	Visible Hidden
<p>This parameter makes the menu item "Change, lowering for "Standby" profile, heating" in menu level 2 visible or invisible. This menu item is assigned to the menu item group Continuous controller in menu level 2. If the Continuous controller menu item group is made invisible, then this menu entry can also no longer be recalled. This parameter is only visible when the controller mode is configured as "Hotel".</p>	
Change setpoint temperature "Comfort" profile, cooling	Visible Hidden
<p>This parameter makes the menu item "Change setpoint temperature, cooling comfort mode" in menu level 2 visible or invisible. This menu item is assigned to the menu item group Continuous controller in menu level 2. If the Continuous controller menu item group is made invisible, then this menu entry can also no longer be recalled. This parameter is only visible when the controller mode is configured as "Hotel".</p>	
Change, raising "Comfort-" profile, cooling	Visible Hidden
<p>This parameter makes the menu item "Change, raising "Comfort-" profile, cooling" in menu level 2 visible or invisible. This menu item is assigned to the menu item group Continuous controller in menu level 2. If the Continuous controller menu item group is made invisible, then this menu entry can also no longer be recalled. This parameter is only visible when the controller mode is configured as "Hotel".</p>	
Change, raising "Eco" profile, cooling	Visible Hidden
<p>This parameter makes the menu item "Change, raising "Eco" profile, cooling" in menu level 2 visible or invisible. This menu item is assigned to the menu item group Continuous controller in menu level 2. If the Continuous controller menu item group is made invisible, then this menu entry can also no longer be recalled. This parameter is only visible when the controller mode is configured as "Hotel".</p>	

Change, raising "Standby" profile, cooling	Visible Hidden
<p>This parameter makes the menu item "Change, raising "Standby" profile, cooling" in menu level 2 visible or invisible. This menu item is assigned to the menu item group Continuous controller in menu level 2. If the Continuous controller menu item group is made invisible, then this menu entry can also no longer be recalled. This parameter is only visible when the controller mode is configured as "Hotel".</p>	
Fan control menu item group	Visible Hidden
<p>This parameter makes the menu item group Fan control in menu level 2 visible or invisible. Menu item groups summarise menu entries. If a menu item group is made invisible, then the assigned menu entries can no longer be recalled.</p> <p>i Depending on the configured controller mode ("KNX" or "Hotel"), the ETS makes additional entries available.</p>	
Change for Fan control standby mode	Visible Hidden
<p>This parameter makes the menu item "Change, Fan control standby mode" in menu level 2 visible or invisible. This menu item is assigned to the menu item group Fan control in menu level 2. If the Fan control menu item group is made invisible, then this menu entries can also no longer be recalled. This parameter is only visible when the controller mode is configured as "KNX".</p>	
Change, Fan control night mode	Visible Hidden
<p>This parameter makes the menu item "Change, Fan control night mode" in menu level 2 visible or invisible. This menu item is assigned to the menu item group Fan control in menu level 2. If the Fan control menu item group is made invisible, then this menu entries can also no longer be recalled. This parameter is only visible when the controller mode is configured as "KNX".</p>	
Change, Fan control, "Comfort-" profile	Visible Hidden
<p>This parameter makes the menu item "Change, Fan control, "Comfort-" profile" in menu level 2 visible or invisible. This menu item is assigned to the menu item group Fan control in menu level 2. If the Fan control menu item group is made invisible, then this menu entries can also no longer be recalled. This parameter is only visible when the controller mode is configured as "Hotel".</p>	

Change, Fan control, "Eco" profile	Visible Hidden
<p>This parameter makes the menu item "Change, Fan control, "Eco" profile" in menu level 2 visible or invisible. This menu item is assigned to the menu item group Fan control in menu level 2. If the Fan control menu item group is made invisible, then this menu entries can also no longer be recalled. This parameter is only visible when the controller mode is configured as "Hotel".</p>	

Change, Fan control, "Standby" profile	Visible Hidden
<p>This parameter makes the menu item "Change, Fan control, "Standby" profile" in menu level 2 visible or invisible. This menu item is assigned to the menu item group Fan control in menu level 2. If the Fan control menu item group is made invisible, then this menu entries can also no longer be recalled. This parameter is only visible when the controller mode is configured as "Hotel".</p>	

Menu item group Device configuration	Visible Hidden
<p>This parameter makes the menu item group Device configuration in menu level 2 visible or invisible. Menu item groups summarise menu entries. If a menu item group is made invisible, then the assigned menu entries can no longer be recalled. This menu item group comprises the menu items "Temperature measurement offset setting", "Reset to factory settings", "Disable controller", "Display brightness setting", "Display contrast setting" and "Display illumination period setting".</p>	

Display

No parameters are shown on this parameter page. The "Display" parameter page is subordinate to the "Display general" parameter page.

Display

The "Display general" parameter page is subordinate to the "Menu level 2" parameter page if the menu levels are enabled.

Overwrite display brightness after ETS download	no yes
<p>The brightness can be changed in three levels in menu level 2 or optionally in the parameters of the ETS. In the "Yes" setting, a further parameter is enabled for defining the brightness. In the "No" setting, the brightness of the display can still be changed in menu level 2. After first commissioning, the brightness is set to 100 %.</p>	

Display brightness	Level 1 Level 2 Level 3
<p>This parameter specifies the brightness of the display if the parameter "Overwrite display brightness after ETS download" is set to "Yes". The value configured here can be overwritten after commissioning of the device locally in menu level 2.</p>	

Overwrite display contrast after ETS download	no yes
<p>The contrast can be changed in three levels in menu level 2 or optionally in the parameters of the ETS. In the "Yes" setting, a further parameter is enabled for defining the contrast. In the "No" setting, the contrast of the display can still be changed in menu level 2. After first commissioning, it is set to 100 %.</p>	
Display contrast	Level 1 Level 2 Level 3
<p>This parameter specifies the contrast of the display if the parameter "Overwrite display contrast after ETS download" is set to "Yes". The value configured here can be overwritten after commissioning of the device locally in menu level 2.</p>	
Switch-off after	15 s 20 s 60 s 90 s 120 s
<p>The display is switched off automatically after the time set here, if it has been switched on by actuation of a sensor button.</p>	
Menu levels	Enabled Disabled
<p>The menu levels make it possible to make various basic settings on the unit locally without using the ETS. In order to avoid the unintentional disruption of essential functions, access to the menu levels can be prevented by setting this parameter to "Disabled". The setting "Enabled" allows access to the menu levels. Then, the "Menu level 2" parameter page is shown in the ETS with additional parameters.</p>	

10 Functional description of the room temperature controller

10.1 Operating modes and operating mode change-over

Introduction

A room temperature controller distinguishes between two different operating modes. The operating modes specify whether you want the controller to use its variable to trigger heating systems ("heating" single operating mode) or cooling systems ("cooling" single operating mode). You can also activate mixed operation, with the controller being capable of changing over between "Heating" and "Cooling" either automatically or, alternatively, controlled by a communication object.

The parameter "Operating mode" in the "Room temperature control -> RTC - General" parameter branch specifies the operating mode.

"Heating" or "cooling" single operating modes

In the single "Heating" or "Cooling" operating modes, the controller will always work with one command value. Depending on the room temperature determined and on the specified setpoint temperatures of the operating modes, the room temperature controller will automatically decide whether heating or cooling energy is required and calculates the command value for the heating or cooling system.

"Heating and cooling" mixed operating mode

In the "Heating and cooling" mixed operating mode, the controller is capable of triggering heating and cooling systems. In this connection, you can set the switch-over behaviour of the modes.

- "Switchover between heating and cooling" parameter in the "Room temperature control -> RTC - General" parameter branch set to "Automatic".
In this case, a heating or cooling mode is automatically activated, depending on the determined room temperature and on the specified setpoint temperature. If the room temperature is within the preset deadband neither heating nor cooling will take place (both command values = "0"). The communication object "Setpoint temperature" displays the most recently active setpoint temperature for heating or cooling. If the room temperature is higher than the cooling setpoint temperature, cooling will take place. If the room temperature is higher than the heating setpoint temperature, heating will take place.
When the operating mode is changed over automatically, the information can be actively sent to the bus via the object "Heating/cooling switchover" to indicate whether the controller is working in the heating mode ("1" telegram) or in the cooling mode ("0" telegram). In this case, a telegram will be transmitted immediately on changing from heating to cooling (object value = "0") or from cooling to heating (object value = "1"), respectively.
The "Cyclical transmission heating/cooling change-over" parameter enables cyclic transmission (factor > "0" setting) and specifies the cycle time.
With an automatic operating mode change-over, it should be noted that under certain circumstances there will be continuous change-over between heating and cooling if the deadband is too small. For this reason, you should, if pos-

sible, not set the deadband (temperature difference between the setpoint temperatures for the comfort heating and cooling modes) below the default value (2 K).

- "Switchover between heating and cooling" parameter in the "Room temperature control -> RTC - General" parameter branch set to "Via object". In this case, the operating mode is controlled via the "Heating/cooling switchover" object, irrespective of the deadband. This type of change-over can, for example, become necessary if both heating and cooling should be carried out through a one-pipe system (heating and cooling system). For this, the temperature of the medium in the single-pipe system must be changed via the system control. Afterwards the heating/cooling operating mode is set via the object (often the single-pipe system uses cold water for cooling during the summer, hot water for heating during the winter).
The "Heating/cooling switchover" object has the following polarities: "1": Heating; "0": Cooling. After a reset, the object value will be "0", and the "Heating/cooling operating mode change-over after reset" set in the ETS will be activated. You can use the "Heating/cooling operating mode after reset" parameter to set which mode you want to activate after a reset. For the "Heating" or "Cooling" settings, the controller will activate the configured heating/cooling operating mode immediately after the initialisation phase. In case of parameterisation "Operating mode before reset" the operating mode which was selected before the reset will be activated.

- i** Setpoint temperatures can be specified for each operating mode ("KNX" controller mode) or for each profile ("Hotel" controller mode) in the ETS as part of configuration.
- i** It is not possible to heat and cool at the same time (both command values for heating and cooling > "0"). With pulse width-modulated command value output (PWM), the command values are only adjusted by the controller at the end of a PWM cycle. The controller always recalculates and updates signal telegrams (1-bit) for "Heating" and "Cooling" cyclically every 30 seconds. The different update intervals for the PWM command values and the signal telegrams mean that there may be a brief overlap of the request for heating or cooling energy by the command values and by the signal telegrams at the transition between heating and cooling. This overlapping is corrected automatically at the end of a PWM cycle by adjusting the command values.

Heating/cooling message

Depending on the set operating mode, separate objects can be used to indicate whether the controller is currently demanding heating or cooling energy and is thus actively heating or cooling. As long as the heating command value is > "0", a "1" telegram will be transmitted through the "Heating" signal object. The signal telegram is only reset when the command value is "0" ("0" telegram is transmitted). The same applies to the signal object for cooling.

The signal objects can be enabled by the "Heating message" or "Cooling message" parameters in the "Room temperature control -> RTC - General -> RTC - Command value and status output" parameter branch. The control algorithm controls the signal objects. Please note that the command values are recalculated every 30 s, thus updating the signal objects.

i With pulse width-modulated command value output (PWM), the command values are only adjusted by the controller at the end of a PWM cycle. The different update intervals for the PWM command values and the signal telegrams mean that there may be a brief overlap of the request for heating or cooling energy by the command values and by the signal telegrams at the transition between heating and cooling. This overlapping is corrected automatically at the end of a PWM cycle by adjusting the command values.

10.2 Control algorithms and calculation of command values

Introduction

To facilitate convenient temperature control in living or business spaces a specific control algorithm which controls the installed heating or cooling systems is required. Taking account of the preset temperature setpoints and the actual room temperature, the controller thus determines command values which trigger the heating or the cooling system. The control system (control circuit) consists of a room temperature controller, a valve drive or an actuator with switching output signals, the actual heating or cooling element (e.g. radiator or cooling ceiling) and of the room. This results in a controlled system (see figure 40).

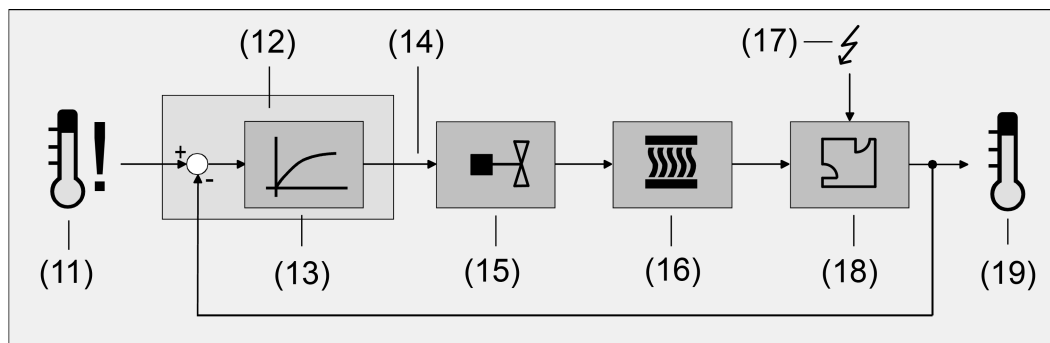

Image 40: Controlled system of single-room temperature control

- (11) Setpoint temperature specification
- (12) Room temperature controller
- (13) Control algorithm
- (14) Command value
- (15) Valve control (valve drive, ETD, heating actuator, ...)
- (16) Heat / cold exchanger (radiator, cooling ceiling, FanCoil, ...)
- (17) Fault variable (sunlight penetration, outdoor temperature, illumination systems, ...)
- (18) Room

(19) Actual temperature (room temperature)

The controller evaluates the actual temperature (19) and compares it with the specified setpoint temperature (11). With the aid of the selected control algorithm (13), the command value (14) is then calculated from the difference between the actual and the setpoint temperature. The command value controls valves or fans for heating or cooling systems (15), meaning that heating or cooling energy in the heat or cold exchangers (16) is passed into the room (18).

Regular readjustment of the command value means that the controller is able to compensate for setpoint / actual temperature differences caused by external influences (17) in the control circuit. In addition, the flow temperature of the heating or cooling circuit influences the control system which necessitates adaptations of the variable.

The room temperature controller facilitates either proportional/integral (PI) feedback control as a continuously working or switching option.

The command values calculated by the control algorithm are output via the "Heating command value" or "Cooling command value" communication objects. Depending on the control algorithm selected for the heating and/or cooling mode, the format of the command value objects is, among other things, also specified. In this way, 1-bit or 1-byte actuating objects can be created. The control algorithm is specified by the parameters "Type of heating control" or "Type of cooling control" in the "Room temperature controller -> RTC - General" parameter branch.

Continuous PI control

PI control is an algorithm which consists of a proportional part and an integral part. Through the combination of these control properties, you can obtain room temperature control as quickly and precisely as possible without or only with low deviations. When you use this algorithm, the room temperature controller will calculate a new continuous command value in cycles of 30 seconds and send it to the bus via a 1-byte value object, if the calculated command value has changed by a specified percentage. The parameter "Automatic transmission on change by" in the parameter branch "Room temperature control -> RTC - General -> RTC - Command value and status output" specifies the change interval in percent.

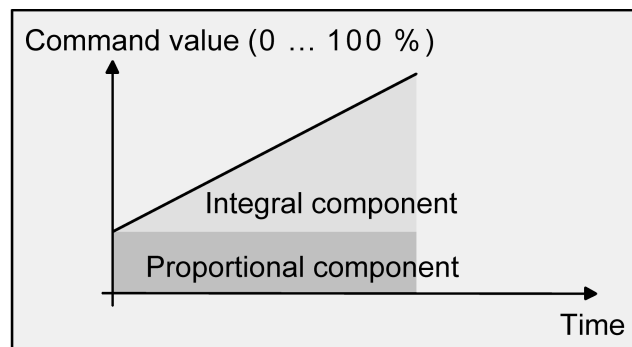

Image 41: Continuous PI control

Switching PI control

With this type of feedback control, the room temperature will also be kept constant by the PI control algorithm. Taking the mean value for a given time, the same behaviour of the control system will result as you would obtain with a continuous controller. The difference compared with continuous feedback control is only the way how the command value is output. The command value calculated by the algorithm in cycles of every 30 seconds is internally converted into a pulse width-modulated (PWM) command value signal and sent to the bus via a 1-bit switching object after the cycle time has elapsed. Taking the cycle time settable using the parameter "Cycle time of the switching command value" in the "Room temperature control -> RTC - General -> RTC - Command value and status output" parameter branch, the mean value of the command signal resulting from this modulation is a measure for the centred valve position of the control valve and thus a reference for the set room temperature.

A shift of the mean value, and thus a change in the heating capacity, can be obtained by changing the duty factor of the switch-on and switch-off pulses of the command value signal. The duty factor will be adapted by the regulator only at the end of a time period, depending on the variable calculated. This applies to any change of the command value, regardless of what the ratio is by which the command value changes (the "Automatic transmission on change by..." and "Cycle time for automatic transmission" have no function here).

Each command value calculated last during an active time period will be converted. Even after you have changed the setpoint temperature, for example, by switching over the operating mode, the command value will still be adapted after the end of an active cycle time. The diagram below shows the output command value switching signal according to the internally calculated command value (first of all, a command value of 30 %, then of 50 %, with the command value output not being inverted).

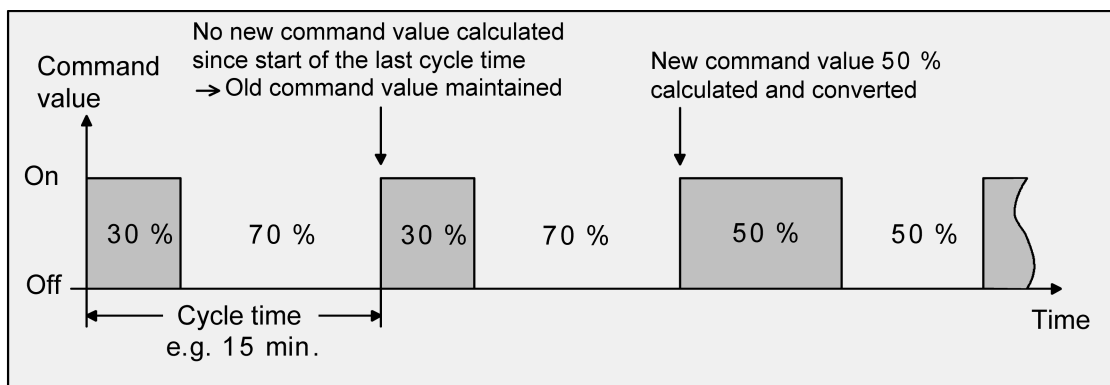

Image 42: Switching PI control

For a command value of 0 % (permanently off) or of 100 % (permanently on), a command value telegram corresponding to the command value ("0" or "1") will always be sent after a cycle time has elapsed.

For switching PI control, the controller will always use continuous command values for internal calculation. Such continuous values can additionally be sent to the bus via a separate 1-byte value object, for example, as status information for visualisation purposes. The status value objects will be updated at the same time as the command value is output and will only take place after the configured cycle time has elapsed.

The parameters "Automatic transmission at modification by ..." and "Cycle time for automatic transmission ..." have no function here. All PWM control options will use the same cycle time.

Cycle time:

The pulse-width-modulated command values are mainly used for activating electrothermal drives (ETD). In this regard, the room temperature controller sends the switching command value telegrams to a actuator equipped with semiconductor switching elements to which the drives are connected (e.g. heating actuator). By setting the cycle time of the PWM signal on the controller, you can adapt the feedback control to the drives used. The cycle time sets the switching frequency of the PWM signal and allows adaptation to the adjusting cycle times of the valve drives used (the adjusting time it takes the drive to bring the valve from its completely closed to its completely opened position). In addition to the adjusting cycle time, take account of the dead time (the time in which the actuators do not show any response when being switched on or off). If different actuators with different adjusting cycle times are used, take account of the longest of the times. Always note the information given by the manufacturers of the actuators.

During cycle time configuration, a distinction can always be made between two cases...

Case 1: Cycle time $> 2 \times$ adjusting cycle time of the electrothermal drives used (ETA)

In this case, the switch-on or switch-off times of the PWM signal are long enough for the actuators to have sufficient time to fully open or fully close within a given time period.

Advantages:

The desired mean value for the command value and thus for the required room temperature will be set relatively precisely, even for several actuators triggered at the same time.

Disadvantages:

It should be noted, that, due to the full valve lift to be continuously 'swept', the life expectancy of the actuators can diminish. For very long cycle times (> 15 minutes) with less sluggishness in the system, the heat emission into the room, for example, in the vicinity of the radiators, can possibly be non-uniform and be found disturbing.

- i This setting is recommended for sluggish heating systems (such as underfloor heating).
- i Even for a bigger number of triggered actuators, maybe of different types, this setting can be recommended to be able to obtain a better mean value of the adjusting travels of the valves.

Case 2: Cycle time $<$ adjusting cycle time of the electrothermal drives used (ETA)

In this case, the switch-on or switch-off times of the PWM signal are too short for the actuators to have enough time to fully open or fully close within a given period.

Advantages:

This setting ensures continuous water flow through the radiators, thus facilitating uniform heat emission into the room.

If only one valve drive is triggered the controller can continuously adapt the command value to compensate the mean value shift caused by the short cycle time, thus setting the desired room temperature.

Disadvantages:

If more than one drive is triggered at the same time the desired mean value will become the command value, which will result in a very poor adjustment of the required room temperature, or in adjustment of the latter with major deviations, respectively. The continuous flow of water through the valve, and thus the continuous heating of the drives causes changes to the dead times of the drives during the opening and closing phase. The short cycle time and the dead times means that the required variable (mean value) is only set with a possibly large deviation. For the room temperature to be regulated constantly after a set time, the controller must continually adjust the command value to compensate for the mean value shift caused by the short cycle time. Usually, the control algorithm implemented in the controller (PI control) ensures that control deviations are compensated.

- i** This setting is recommended for quick-reaction heating systems (such as surface radiators).

10.3 Adapting the control algorithms

Adapting the PI control

In a building, different systems can be installed which heat up or cool down a room. One option is to uniformly heat or cool the surroundings via heat transfer media (preferably water or oil) in connection with room air convection. Such systems are used, for example, with wall mounted heaters, underfloor heating or cooling ceilings. Alternatively or additionally forced air systems may heat or cool rooms. In most cases such systems are electrical forced hot air systems, forced cool air systems or refrigerating compressors with fan. Due to the direct heating of the room air such heating and cooling systems work quite swiftly.

The control parameters need to be adjusted so that the PI control algorithm may efficiently control all common heating and cooling systems thus making the room temperature control work as fast as possible and without deviation. Certain factors can be adjusted with a PI control that can influence the control behaviour quite significantly at times. For this reason, the room temperature controller can be set to predefined control parameters for the most common heating and cooling systems. In case the selection of a corresponding heating or cooling system does not yield a satisfactory result with the default values, the adaptation can optionally be optimised using control parameters.

Predefined control parameters for the heating or cooling stage are set using via the "Type of heating" or "Type of cooling" parameters. These fixed values correspond to

the practical values of a properly planned and executed air conditioning system and will result in an ideal behaviour of the temperature control. The heating and cooling types shown in the following tables can be set for heating and cooling operation.

Type of heating	Proportional range (preset)	Reset time (preset)	Recommended PI control type	Recommended PWM cycle time
Fan coil unit	4 Kelvin	90 minutes	Continuous	---
Split unit (split climate control unit)	4 Kelvin	90 minutes	PWM	10-15 min.

Predefined control parameters and recommend control types for heating systems

Cooling type	Proportional range (preset)	Reset time (preset)	Recommended PI control type	Recommended PWM cycle time
Fan coil unit	4 Kelvin	90 minutes	Continuous	---
Split unit (split climate control unit)	4 Kelvin	90 minutes	PWM	10-15 min.

Predefined control parameters and recommend control types for cooling systems

If the "Type of heating" or "Type of cooling" parameters are set to "Via control parameters", it is possible to adjust the control parameters manually. The feedback control may be considerably influenced by presetting the proportional range for heating or for cooling (P component) and the reset time for heating or for cooling (I component).

- i** Even small adjustments of the control parameters will lead to noticeable different control behaviour.
- i** The adaptation should start with the control parameter setting for the corresponding heating or cooling system according to the specified fixed values mentioned in the above tables.

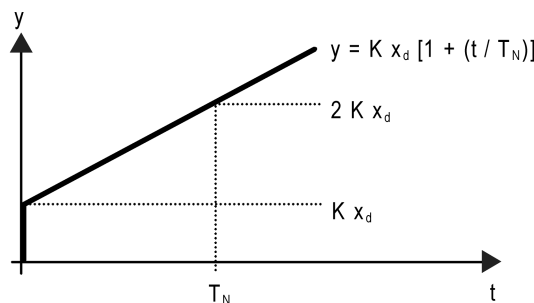

Image 43: Function of the command value of a PI control

y: Command value
 x_d : control difference ($x_d = x_{set} - x_{act}$)
 $P = 1/K$: Configurable proportional band

$K = 1/P$: Gain factor
 T_N : parameterisable reset time

PI control algorithm: Command value $y = K x_d [1 + (t / T_N)]$

Deactivation of the reset time (setting = "0") ->
 P control algorithm: Command value $y = K x_d$

Parameter setting	Effect
P: Small proportional range	Large overshoot in case of setpoint changes (possibly permanently), quick adjustment to the setpoint
P: Large proportional range	no (or small) overshooting but slow adjustment
T_N : Short reset time	Fast compensation of control deviations (ambient conditions), risk of permanent oscillations
T_N : Long reset time	Slow compensation of control deviations

Effects of the settings for the control parameters

10.4 Operating mode switchover / profile switchover

The room temperature controller supports either four or five different energy levels, depending on the controller mode to which it is configured. The "Controller mode" parameter on the "General -> Basic settings" parameter page configures the room temperature controller to the desired mode.

In the "KNX" controller mode, the energy levels are termed operating modes. The controller or the controller extension possesses the operating modes "Comfort mode", "Standby", "Night" and "Frost/heat protection". The operating modes for the "KNX" controller mode are described in a separate chapter in this product documentation (siehe Kapitel "Operating mode switchover ("KNX" controller mode)" ▶ Page 56).

In the "Hotel" controller mode, the energy levels are termed profiles. The controller or the controller extension possesses the profiles "Comfort", "Comfort-", "Eco", "Standby" and "Building Protection". The profiles for the "Hotel" controller mode are described in a separate chapter in this product documentation (siehe Kapitel "Profile switchover ("Hotel" controller mode)" ▶ Page 62).

Irrespective of the configured controller mode, the device uses the same icons for showing the energy level in the display.

Icon	Operating mode	Profile
No icon	Comfort mode	Comfort
☆	Standby mode	Comfort-
🌙	Night operation	Eco

Icon	Operating mode	Profile
⏻	---	Standby
❄️❄️	Frost/heat protection mode	Building Protection

Icons for displaying the energy level

In the "Standby" and "Night" operating modes ("KNX" controller mode) and in the "Comfort-", "Eco" and "Standby" profiles, the sensor buttons have no influence on fan control. The fan control function method for this energy level can be configured in the parameters of the ETS. The "Fan control ..." parameters on the parameter page "RTC - Fan control" configure fan control for the operating modes "Standby operation" and "Night operation" and for the "Comfort-", "Eco" and "Standby" profiles. If menu level 2 is enabled, then these settings can be adjusted at a later time menu level 2.

10.4.1 Operating mode switchover ("KNX" controller mode)

Introduction - The operating modes

The room temperature controller in "KNX" controller mode has various operating modes. The selection of these modes will, for example, facilitate the activation of different temperature setpoints, depending on the presence of a person, on the state of the heating or cooling system, on the time of the day, or on the day of the week. The following operating modes can be distinguished:

- Comfort mode

Comfort mode is usually activated if persons are in a room, and the room temperature should, for this reason, be adjusted to an adequately convenient value. The switchover to this operating mode can take place either by specifying an operating mode via the operating mode switchover or with presence control, for example, using a PIR presence detector on the wall or a ceiling mounted presence detector.

- Standby mode ☆

If a room is not used during the day because persons are absent, you can activate the Standby mode. Thereby, you can adjust the room temperature on a standby value, thus to save heating or cooling energy, respectively.

- Night mode ↷

During the night hours or during the absence of persons for a longer time, it mostly makes sense to adjust the room temperature to lower values for heating systems (e.g. in bedrooms). In this case, cooling system can be set to higher temperature values, if air conditioning is not required (e.g. in offices). For this purpose, you can activate the Night mode.

- Frost/heat protection mode ❄️❄️

Frost protection will be required if, for example, the room temperature must not fall below critical values while the window is open. Heat protection can be re-

quired where the temperature rises too much in an environment which is always warm, mainly due to external influences. In such cases, you can activate the Frost/heat protection operating mode and prescribe some temperature setpoint of its own for either option, depending on whether "Heating" or "Cooling" has been selected, to prevent freezing or overheating of the room.

- i** Separate setpoint temperatures can be preset for the "Heating" and "Cooling" modes of the "Comfort", "Standby" and "Night" operating modes.
- i** The temperature setpoints are permanently set for the "Frost/heat protection" operating mode. The temperature setpoint for heating mode (frost protection) is 7 °C and the temperature setpoint for cooling mode (heat protection) is 45 °C.

Operating mode switchover

The operating modes are switched over using the sensor buttons on the device (siehe Kapitel "Operating level" ▶ Page 13) or using KNX operating mode objects. The operating mode switchover through KNX operating mode objects takes place using a 1-byte value object.

The sensor buttons T3.2 and T4.2 switch over the operating mode and also affect the forced operating mode. If the operating modes "Night" or "Frost/heat protection" are recalled using the sensor buttons on the device, then the controller works in the forced operating mode. In consequence, the device no longer reacts to operating mode switchovers via the "Controller - Operating mode switchover input" object. For an object-guided operating mode switchover, the 1-byte object "Controller - Forced object operating mode input" must be written with the value "00" (auto "normal operating mode switchover") via the bus. An object-guided operating mode switchover is also possible if the "Standby" operating mode was recalled using the sensor buttons on the device.

The device then shows the actually set operating mode on the display. The actually set operating mode is transmitted to the bus via the "Currently active operating mode" object.

- i** The "KNX operating mode status" also sends its status to the bus after an operating mode switchover. Depending on the status of the presence, window and forced operating mode, the "KNX operating mode status" may deviate from the currently active operating mode.

There is a common 1-byte switchover object for all operating modes. During the running time, the operating mode can be changed over through this value object immediately after the receipt of only one telegram. In this connection, the value received will set the operating mode. In addition, a second 1-byte object is available which, by forced control and through a higher level, can set an operating mode, irrespective of any other switchover options. Both 1-byte objects have been implemented according to the KNX specification. Taking the priority into account, a specific switchover hierarchy will result from the operating mode switchover by the objects.

The presence status can be evaluated by the controller. As soon as the controller re-

ceives a "1" via the "Presence detector" object, the controller switches from Standby mode to Comfort mode. The presence status can be permanently configured to available in the parameters. A normal operating mode switchover is then not possible. The corresponding communication object is not available. A forced operating mode switchover is possible.

The status of the window in the room can be evaluated using the "Window status" object, meaning that, when the window is open, the controller can switch to Frost/heat protection mode, irrespective of the set operating mode, in order to save energy.

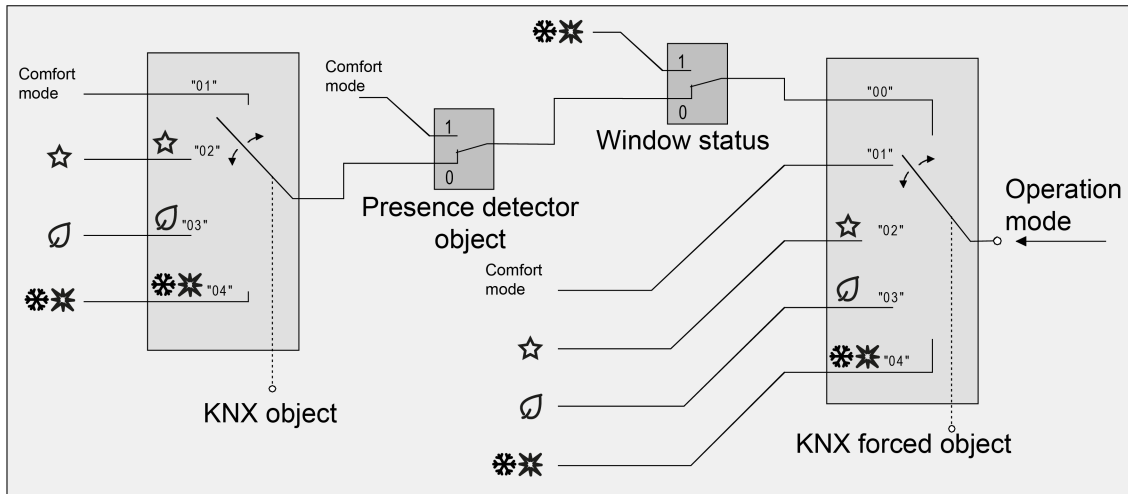

Image 44: Operating mode switchover through KNX object with presence detector

Object value Operating mode switch-over	Object value Forced ob- ject Oper.m.	object Window status	Motion status	resulting Operating mode
00	00	0	0	No modification
01	00	0	0	Comfort mode
02	00	0	0	Standby mode
03	00	0	0	Night operation
04	00	0	0	Frost/heat protection
X	00	0	1	Comfort mode
X	00	1	X	Frost/heat protection
X	00	1	-	Frost/heat protection
X	01	X	X	Comfort mode
X	02	X	X	Standby mode

Object value Operating mode switch-over	Object value Forced ob- ject Oper.m.	object Window status	Motion status	resulting Operating mode
X	03	X	X	Night operation
X	04	X	X	Frost/heat protection

Status of the communication objects and the resulting operating mode

X: Status irrelevant

- i** The setting of the parameter "Presence permanently active" influences the presence detection of the room temperature controller. The presence status of the room temperature controller is permanently set to available if the parameter is set to "Yes". If the parameter is configured to "No", presence detection takes place via the "Presence detector" object.
- i** After bus voltage recovery or an ETS programming operation (controller re-set), the value which corresponds to the set operating mode is actively transmitted to the bus, if the "Transmit" flag has been set.

Additional information on the Presence function

The setting of the parameter "Presence permanently active" influences the presence detection of the room temperature controller. The presence status of the room temperature controller is permanently set to available if the parameter is set to "Yes". If the parameter is configured to "No", presence detection takes place via the "Presence detector" object. With this object, it is possible to integrate presence detectors or hotel card switches into room temperature control.

The presence status influences the "Comfort" and "Standby" operating modes. If presence is detected, Comfort mode can be recalled via the sensor buttons on the device.

If presence is detected, the sensor buttons T3.2 and T4.2 have the following function:

- Sensor button T3.2 causes a switchover between the operating modes "Comfort" and "Night".
- Sensor button T4.2 causes a switchover between the operating modes "Comfort" and "Frost/heat protection".

- i** In this connection, it is irrelevant what has been set by the switchover objects. Only a window contact or the KNX forced object are of higher priority.

If no presence is detected, the sensor buttons T3.2 and T4.2 have the following function:

- Sensor button T3.2 causes a switchover between the operating modes "Standby" and "Night".
- Sensor button T4.2 causes a switchover between the operating modes "Standby" and "Frost/heat protection".

- i** With presence detection via the "Presence detector" object, an active presence function is always deleted on a device reset (bus voltage failure, ETS programming operation). In this case, the presence detector must transmit a new "1"-telegram to the controller to activate the presence function.

Additional information on the window status and the automatic frost protection

The room temperature controller offers various options to change over into the Frost/heat protection mode. In addition to switching over by means of the corresponding operating mode switchover object, frost/heat protection can be activated by a window contact, or alternatively, the frost protection can be activated by an automatic temperature function. The window contact or the automatic function has higher priority. The "Frost/heat protection" parameter in the "Room temperature control -> RTC - General" parameter branch specifies the way in the switch-over to forced frost/heat protection takes place...

- Frost/heat protection switch-over "via window status"
The 1-bit object "Window status" is enabled. A telegram having the value of = "ON" (open window) and sent to this object will activate the frost/heat protection mode. If this is the case, the operating mode cannot be deactivated by the switchover objects (except for the KNX forced object) or the presence function. Only a telegram with the value = "OFF" (closed window) will reset the window status and deactivate the frost/heat protection mode. After this, the operating mode set before the opening of the window or that mode carried by the bus while the window was open will be activated.
You can optionally configure a delay for the evaluation of the window status. Such delay can make sense if short ventilation of the room by opening the window is not supposed to change the operating mode. You can use the "window status delay" parameter to set this delay time between 1 and 255 minutes. The window status will only be changed and thus the frost/heat protection mode activated after this parameterized time has elapsed. A setting of "0" will effect the immediate activation of the frost/heat protection mode when the window is open. The window status will be in effect in the heating and in the cooling mode. After a bus voltage failure or ETS programming operation, the window status is always inactive.
- Frost protection mode switch-over by "automatic frost protection"
For this setting, automatic switch-over to the frost protection mode can be made at times, depending on the room temperature determined. If there are no window contacts, this setting can prevent unnecessary heating up of a room when windows or external doors are open. With this function, a quick temperature drop can be detected by measuring the actual temperature every minute as, for example, is the case when a window is open in the winter months. You can use the "automatic frost protection temperature drop" parameter to set the maximum temperature drop in K/min for switching over to the frost protection mode. If the controller detects that the room temperature has changed by at least the configured temperature jump within one minute, frost protection will be activated. After the time specified by the "Frost protection period in automatic mode" parameter has elapsed, the controller again automatically switches to the operating mode which was set before frost protection or which was tracked during automatic operation. It is not possible to retrigger

an elapsing frost protection period.

The KNX forced object has a higher priority than the automatic frost protection mode and can interrupt the latter.

- i** The automatic frost protection mode only acts on heating for temperatures below the set value temperature of the operating mode selected. Thus, no automatic switchover to frost protection can take place at room temperatures in the deadband or in the active cooling mode if the "Heating and cooling" operating mode is on. Automatic heat protection activation is not intended with this parameterization.
- i** Frequent draughts in a room can cause unintentional activation/deactivation of frost protection when the automatic frost protection mode is active and if the set temperature decrease is too low. Therefore switching into the frost/heat protection mode by window contacts should generally be preferred to the automatic option.

Additional information on the operating mode after a reset

In the ETS, it is possible to use the "Operating mode after reset" parameter in the "Room temperature control -> RTC - General" parameter node to specify which operating mode should be activated after bus voltage return or an ETS programming operation. The following settings are possible:

- "Comfort operation" -> The comfort mode will be activated after the initialisation phase.
 - "Standby mode" -> The standby mode will be activated after the initialisation phase.
 - "Night operation" -> The night mode will be activated after the initializing phase.
 - "Frost/heat protection operation" -> The frost/heat protection mode will be activated after the initialisation phase.
 - "Restore operating mode before reset" -> The mode set before a reset according to the operating mode objects will be restored after the initialisation phase of the device. Operating modes set by a function with a higher priority before the reset (Forced, Window status, Presence status) are not effected.
- i** The parameter "Operating mode after reset" is permanently set to "Comfort operation", if the controller mode is configured as "KNX" and the parameter "Parameter permanently active" is configured to "Yes".

10.4.2 Profile switchover ("Hotel" controller mode)

Introduction - The profiles

The room temperature controller in "Hotel" controller mode has various profiles. The activation of these profiles will, for example, facilitate the activation of different temperature setpoints, depending on the presence of a person, on the state of the heating or cooling system, on the time of the day or on the day of the week. The following profiles can be distinguished:

- Comfort

The "Comfort" profile is usually activated if people are in a room, and the room temperature should, for this reason, be adjusted to an adequately convenient value. The switchover to this profile can take place either by specifying an operating mode via the operating mode switchover or with presence control, for example, using a hotel card switch on the wall or a ceiling mounted presence detector.

- Comfort- ☆

If a room is not used during the day because people are absent, you can activate the "Comfort-" profile. Thereby, you can adjust the room temperature to a "Comfort-" value, thus to save heating or cooling energy, respectively.

- Eco ↻

During the night hours, it mostly makes sense to adjust the room temperature to lower values for heating systems (e.g. in bedrooms). In this case, cooling system can be set to higher temperature values, if air conditioning is not required (e.g. in offices). For this purpose, you can activate the "Eco" profile.

- Standby ⏻

During the absence of people for a longer time, it mostly makes sense to adjust the room temperature to lower values for heating systems (e.g. in bedrooms). In this case, cooling system can be set to higher temperature values, if air conditioning is not required (e.g. in offices). For this purpose, you can activate the "Standby" profile.

- Building Protection ❄❄

Building Protection will be required if, for example, the room temperature must not fall below critical values while the window is open. It can also be required where the temperature rises too much in an environment which is always warm, mainly due to external influences. In such cases, you can activate the Building Protection operating mode and specify your own temperature setpoint for either option, depending on whether "Heating" or "Cooling" has been selected, to prevent freezing or overheating of the room.

- i Separate setpoint temperatures can be preset for the "Heating" and "Cooling" operating modes of the "Comfort", "Comfort-", "Eco" and "Standby" profiles.

- i** The temperature setpoints are permanently set for the "Building Protection" profile. The temperature setpoint for heating mode (frost protection) is 7 °C and the temperature setpoint for cooling mode (heat protection) is 45 °C.

Profile switchover

The profiles are switched over using the sensor buttons on the device (siehe Kapitel "Operating level" ▶ Page 13) or by the "Profile switchover" and "Profile switchover standby" objects. In addition, in "Hotel" controller mode, the controller monitors the actual temperature in the room. Depending on the temperature, the controller switches to the "Building Protection" profile.

Profile switchover via object

With the profile switchover via object, the received values specify the profile. In addition, two further objects are available which, by forced control and through a higher level, can set a profile, irrespective of any other switchover options. Taking the priority into account, a specific switchover hierarchy will result from the profile switchover by the objects.

The presence status can be evaluated by the controller. As soon as the controller receives a "1" via the "Presence detector" object, the controller switches from the "Comfort-" profile to the "Comfort" profile. The presence status can be permanently configured to available in the parameters. If presence is permanently detected, the "Comfort-" profile cannot be recalled by a normal profile switchover. A forced profile switchover is possible.

The status of the window in the room can be evaluated using the "Window status" object, meaning that, when the window is open, the controller can switch to the "Building Protection" profile, irrespective of the set profile, in order to save energy.

A shared 1-byte switchover object exists for the "Comfort", "Comfort-", "Eco" and "Standby" and "Building Protection" profiles, which distinguishes between 4 profiles. The "Profile switchover" object does not distinguish between the "Eco" and "Standby" profiles. The "Eco" or "Standby" profiles are recalled when the "Profile switchover" object is set to "Eco" / "Standby" via the additional 1-bit "Profile switchover" object.

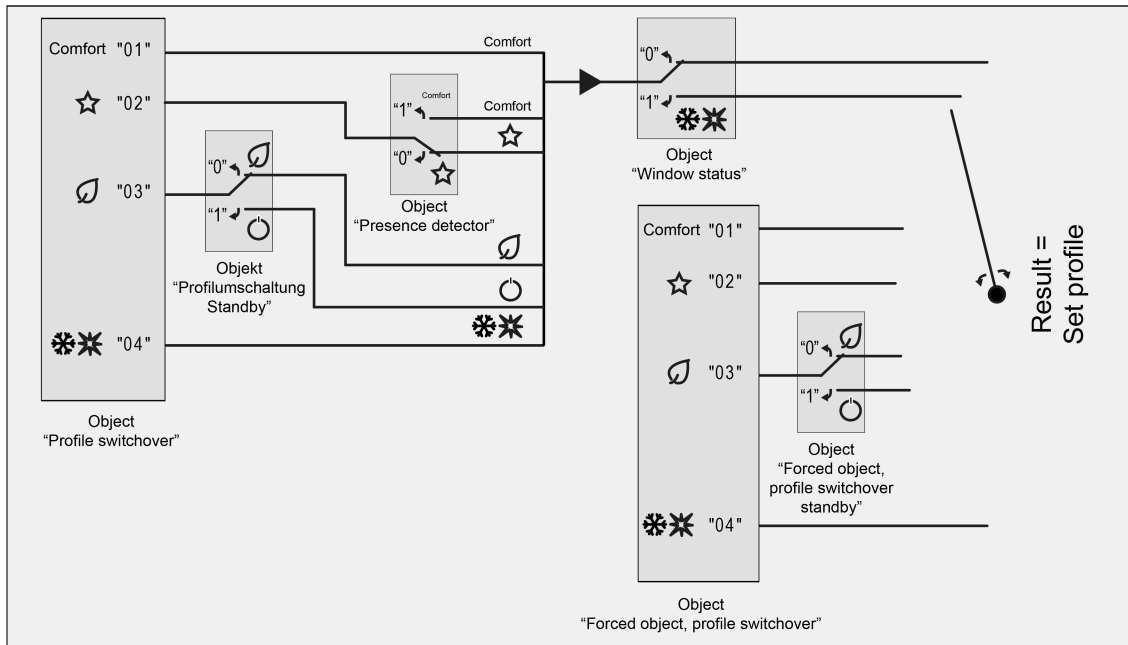

Image 45: Profile switchover through KNX objects with presence detector

Object value „Profile switchover“	Object value „Forced object profile switchover“	Object value „Profile switchover standby“	Object value „Forced object profile switchover standby“	Object value „Window status“	Object value „Presence detector“	Result = Set profile
00	00	X	X	0	0	No modification
01	00	X	X	0	0	Comfort
02	00	X	X	0	0	Comfort-
03	00	0	0	0	X	Eco
03	00	1	0	0	X	Standby
04	00	X	X	0	X	Building Protection
01	00	X	X	0	1	Comfort
02	00	X	X	0	1	Comfort
X	00	X	X	1	X	Building Protection
X	00	X	X	X	X	Comfort
X	01	X	X	X	X	Comfort-
X	02	X	0	X	X	Eco
X	03	X	1	X	X	Standby
X	04	X	X	X	X	Building Protection

Image 46: Status of the communication objects and the resulting profile

X Status irrelevant

- i** After bus voltage return or an ETS programming operation (controller reset), the value which corresponds to the set profile is actively transmitted to the bus, if the "Transmit" flag has been set.

Temperature-dependent profile switchover

With temperature-dependent profile switchover, the controller monitors the actual temperature. If the actual temperature in the Heating operating mode is less than or equal to 7 °C, or, in Cooling mode, is greater than or equal to 45 °C, then the controller automatically switches to the "Building Protection" profile. The controller then works with a setpoint temperature of either 7 °C or 45 °C. The fan control function is permanently set to Automatic mode in the "Building Protection" profile.

- i** The temperature-dependent profile switchover occurs without a time delay.

After a temperature-dependent profile switchover, the "Building Protection" profile remains active until the next profile switchover using the sensor buttons on the device or the objects. The profile is switched over without a time delay and the appropriate setpoint is active. With the profile switchover via the sensor buttons or the objects, the configurable delay time for a temperature-dependent profile switchover begins. During this delay time, the controller does not check the actual temperature. Accordingly, no temperature-dependent profile switchover occurs during this delay time. After this delay time has elapsed, the controller begins monitoring the actual temperature again.

- i** The delay time should be set so that it is long enough for the room to be sufficiently heated or cooled in this period. The delay time should prevent an immediate, temperature-dependent reset to the "Building Protection" profile.

Additional information on the Presence function

The setting of the parameter "Presence permanently active" influences the presence detection of the room temperature controller. The presence status of the room temperature controller is permanently set to available if the parameter is set to "Yes". If the parameter is configured to "No", presence detection takes place via the "Presence detector" object. With this object, it is possible to integrate presence detectors or hotel card switches into room temperature control.

The presence signal influences the "Comfort" and "Comfort-" profiles. If presence is detected, the "Comfort" profile can be recalled via the sensor buttons on the device.

If presence is detected, the sensor buttons T3.2 and T4.2 have the following function:

- The sensor button T3.2 causes a switchover between the "Comfort" and "Eco" profiles.
- Sensor button T4.2 causes a switchover between the operating modes "Comfort" and "Standby".

- i** In this connection, it is irrelevant what has been set by the switchover objects. Only a window contact or the forced object are of higher priority.

If no presence is detected, the sensor buttons T3.2 and T4.2 have the following function:

- Sensor button T3.2 causes a switchover between the operating modes "Comfort-" and "Eco".
- Sensor button T4.2 causes a switchover between the operating modes "Comfort-" and "Standby".

i With presence detection via the "Presence detector" object, an active presence function is always deleted on a device reset (bus voltage failure, ETS programming operation). In this case, the presence detector must transmit a new "1"-telegram to the controller to activate the presence function.

Additional information on the window status and Building Protection

The room temperature controller offers various options to switch over into the "Building Protection" profile. In addition to the switchover by the corresponding profile switchover object, the "Building Protection" profile can be activated by a window contact or, alternatively, by an automatic "Building Protection" option. The window contact or the automatic function has higher priority. The ""Building Protection" profile additionally via" parameter in the "Room temperature control -> RTC - General" parameter branch specifies the way in the switch-over to forced Building Protection takes place:

- Switchover via "Window status"

The 1-bit object "Window status" is enabled. A telegram having the value of = "ON" (open window) and sent to this object will activate the "Building Protection" profile. If this is the case, the profile cannot be deactivated by the switchover objects (except for the forced objects) or the presence function. Only a telegram with the value = "OFF" (closed window) will reset the window status and deactivate the "Building Protection" profile. After this, the profile set before the opening of the window or that mode tracked by the bus while the window was open will be activated.

You can optionally configure a delay for the evaluation of the window status. This delay can make sense if short ventilation of the room by opening the window is not supposed to switch over the profile. You can use the "window status delay" parameter to set this delay time between 1 and 255 minutes. The window status, and thus the "Building Protection" profile, will only be activated after this configured time has elapsed. A setting of "0" will effect the immediate activation of the "Building Protection" profile when the window is open. The window status will be in effect in the heating and in the cooling mode. After a bus voltage failure or ETS programming operation, the window status is always inactive.
- Switchover through "Automatic "Building Protection""

For this setting, automatic switchover to the "Building Protection" profile can be made at certain times, depending on the room temperature determined. If there are no window contacts, this setting can prevent unnecessary heating up of a room when windows or external doors are open. With this function, a quick temperature drop can be detected by measuring the actual temperature every minute as, for example, is the case when a window is open in the winter

months. You can use the "Automatic "Building Protection" temperature reduction" parameter to set the maximum temperature drop in K/min for switching over to the "Building Protection" profile. If the controller detects that the room temperature has changed by at least the configured temperature jump within one minute, the "Building Protection" profile will be activated. After the time preset by the ""Building Protection" period in automatic mode" parameter has elapsed, the controller will automatically return to the previously set profile or the profile tracked during automatic operation. It is not possible to retrigger an elapsing "Building Protection" period.

The forced object has a higher priority than the automatic "Building Protection" and can interrupt the latter.

- i** The automatic "Building Protection" only acts on heating for temperatures below the set value temperature of the selected profile. Thus, no automatic switchover to "Building Protection" can take place at room temperatures in the deadband or in the active cooling mode if the "Heating and cooling" operating mode is on. Automatic activation of the "Building Protection" profile is not intended with this configuration.
- i** Frequent draughts in a room can cause unintentional activation/deactivation of the "Building Protection" profile when automatic "Building Protection" is active and if the set temperature decrease is too low. Therefore, switching to the "Building Protection" profile by window contacts should generally be preferred to the automatic option.

Additional information on the profile after reset

In the ETS, it is possible to use the "Profile after reset" parameter in the "Room temperature control -> RTC - General" parameter node to specify which profile should be activated after bus voltage return or an ETS programming operation. The following settings are possible:

- "Restore profile before reset" -> The profile set before a reset according to the profile switchover will be restored after the initialisation phase of the device. Profiles set by a function with a higher priority before the reset (Forced, Window status, Presence status) are not effected.
- "Comfort" -> The "Comfort" profile will be activated after the initialisation phase.
- "Comfort-" -> The "Comfort-" profile will be activated after the initialisation phase.
- "Eco" -> The "Eco" profile will be activated after the initialisation phase.
- "Standby" -> The "Standby" profile will be activated after the initialisation phase.

10.5 Room temperature measurement

Basic principles

The room temperature controller possesses an integrated temperature sensor, using which the room temperature can be detected. Alternatively (e.g. if the room temperature controller has been installed in an unfavourable location or operates in difficult conditions, for example, in a moist atmosphere) or in addition (e.g. in large rooms or halls), an external temperature sensor can be integrated in the temperature measurement using KNX objects.

The methods for room temperature measurement can be configured on the "General -> Room temperature measurement" parameter page. For each method, the temperature can be detected by the internal sensor, the external sensor or the combination of measured temperature value (internal sensor) and received temperature value (external sensor). The "External sensor" setting enables a communication object for receiving the temperature.

When choosing the installation location of the controller or the external sensor, the following points should be considered:

- The controller or temperature sensor should not be used in multiple combinations, especially together with flush-mounted dimmers.
- Do not install the temperature sensor in the area of large electrical consumers (avoid heat influences).
- The push button sensor should not be installed in the vicinity of radiators or cooling systems.
- The temperature sensor should not be exposed to direct sun.
- The installation of sensors on the inside of an outside wall might have a negative impact on the temperature measurement.
- Temperature sensors should be installed at least 30 cm away from doors, windows or ventilation units and at least 1.5 m above the floor.

i A deviation may occur in the measured temperature after a device reset or after switching on the background illumination of the display. Comparative measurements for the calibration of the room temperature measurement should take place approx. 30 minutes after a device reset or switching on the display.

Temperature detection and measured value formation

The "Temperature detection by" parameter in the "Room temperature measurement" parameter node specifies the sensors to detect the room temperature.

The following settings are possible for temperature detection:

- "Internal sensor"
The temperature sensor integrated in the device is activated. Thus, the actual temperature value is determined only locally on the device.
In this configuration, the feedback control will start directly after a device reset.

- "External sensor"
 The actual temperature is determined solely via a temperature value received from the bus. In this case, the sensor must either be a KNX room thermostat coupled via the 2-byte object "External temperature" or a controller extension with temperature detection.
 The device can request the current temperature value cyclically. For this purpose, the parameter "Request time for external sensor" must be set to a value > "0". The request interval can be configured within the limits of 1 minute to 255 minutes.
 After a device reset the device will first wait for a valid temperature telegram until the feedback control starts and a command value, if applicable, is output.

- "Internal sensor and external sensor"
 This setting is used to combine the selected temperature sources. The sensors can either be a KNX room thermostat coupled via the 2-byte object "External temperature" or controller extensions with temperature detection.
 With the setting "External sensor", the device can request the current temperature value cyclically. For this purpose, the parameter "Request time for external sensor" must be set to a value > "0". The request interval can be configured within the limits of 1 minute to 255 minutes. After a device reset the device will first wait for a valid temperature telegram until the feedback control starts and a command value, if applicable, is output.
 When evaluating, the real actual temperature is made up from the two respective measured temperature values. The weighting of the temperature values is defined by the "Creation of measuring value internal against external" parameter. Depending on the different locations of the sensors or a possible non-uniform heat distribution inside the room, it is thus possible to adjust the actual temperature measurement. Often, those temperature sensors that are subject to negative external influences (for example, unfavourable location because of exposure to sun or heater or door / window directly next to it) are weighted less heavily.

Example: A room temperature controller is installed next to the entrance to the room (internal sensor). An additional wired temperature sensor (external sensor) has been mounted on an inner wall in the middle of the room below the ceiling.

Internal sensor: 21.5 °C

External sensor: 22.3 °C

Determination of measured value: 30 % to 70 %

$$\begin{aligned}
 \rightarrow T_{\text{Result internal}} &= T_{\text{internal}} \cdot 0.3 = 6.45 \text{ °C}, \\
 \rightarrow T_{\text{Result 2}} &= T_2 = 22,3 \text{ °C} \cdot 0,7 = 15,61 \text{ °C} \\
 \rightarrow T_{\text{Result}} &= T_{\text{Result internal}} + T_{\text{Result external}} = \underline{22.06 \text{ °C}}
 \end{aligned}$$

Calibrating the measured values

In some cases during room temperature measurement, it may be necessary to adjust the temperature values of the internal sensor and the external sensor. Adjustment becomes necessary, for example, if the temperature measured by the sensors stays

permanently below or above the actual temperature in the vicinity of the device. To determine the temperature deviation, the actual room temperature should be detected with a reference measurement using a calibrated temperature measuring device. The parameters "Internal sensor calibration" and/or "Calibration of external sensor" can configure the positive (temperature increase, factors: 1 ... 127) or negative (temperature decrease, factors -128... -1) temperature calibration in levels of 0.1 K. Thus, the calibration is made only once statically and is the same for all operating modes of the controller.

- i** The measured value has to be increased, if the value measured by the sensor lies below the actual room temperature. The measured value has to be decreased, if the value measured by the sensor lies above the actual room temperature.
- i** During room temperature control, the device always uses the adjusted temperature value to calculate the command values. The adjusted temperature value is transmitted to the bus via the "Actual temperature" object (siehe Kapitel "Room temperature measurement" ▶ Page 70).
When determining the measured value using the internal and external sensor, the two calibrated values are used to calculate the actual value.
- i** Temperature adjustment only affects the room temperature measurement.

Transmission of the actual temperature

The determined actual temperature can be actively transmitted to the bus via the 2-byte "Actual temperature" object. The "Transmission on room temperature change by" parameter specifies the temperature value by which the actual value has to change in order to have the actual temperature value transmitted automatically via the object. Possible temperature value changes lie within a range of 0.1 K and 25.5 K. Setting to "0" at this point will deactivate the automatic transmission of the actual temperature.

In addition, the actual value can be transmitted periodically. The "Cyclical transmission of the room temperature" parameter determines the cycle time (1 to 255 minutes). The value "0" will deactivate the periodical transmission of the actual temperature value.

Setting the "Read" flag on the "actual temperature" object makes it possible to read out the current actual value at any time over the bus. It has to be pointed out that with deactivated periodical transmission and deactivated automatic transmission, no more actual-temperature telegrams will be transmitted".

Following the return of bus voltage, new programming via the ETS, the object value will be updated according to the actual temperature value and transmitted on the bus. In case a temperature value telegram has not been received from the external sensor via the object "External temperature value" when evaluating an external temperature sensor, only the value provided by the internal sensor will be transmitted. If only the external sensor is used, then the value "0" is located in the "Actual temperature" object after a reset. For this reason, the external temperature sensor should always transmit the current value after a reset.

During room temperature control, the controller always uses the adjusted temperature value to calculate the command values. The adjusted temperature value is transmitted to the bus via the "Actual temperature" object.

10.5.1 Parameter group "Room temperature measurement"

Room temperature measurement

Temperature detection through	Internal sensor External sensor Internal and external sensor
-------------------------------	---------------------------------------------------------------------------

This parameter specifies which sensor is used for room temperature measurement. With the setting "Internal sensor" only the temperature sensor integrated in the device detects the room temperature. With the setting "Received temperature value", only a KNX/EIB temperature sensor (e.g. controller extension) coupled via the "External temperature" object detects the room temperature. With the setting "Internal sensor and received temperature value", the KNX/EIB temperature sensor (e.g. controller extension) integrated into the device and coupled via the "External temperature" object detects the room temperature.

Determination of measured value from internal / external ratio	10% to 90% 20% to 80% 30% to 70% 40% to 60% 50% to 50% 60% to 40% 70% to 30% 80% to 20% 90% to 10%
----------------------------------------------------------------	-----------------------------------------------------------------------------------------------------------------------------------

The weighting of the measured temperature value for the internal and external sensors is specified here. That results in an overall value, which will be used for the further interpretation of the room temperature.

Internal sensor calibration(-128...127 * 0.1 K)	-128... 0 ...127
-------------------------------------------------	-------------------------

Determines the value by which the internal sensor's room temperature value is calibrated. This parameter is only visible when the temperature detection system requires an internal sensor.

External sensor calibration(-128...127 * 0.1 K)	-128... 0 ...127
-------------------------------------------------	-------------------------

Determines the value by which the external sensor's room temperature value is calibrated. This parameter is only visible when the temperature detection system requires an external sensor.

Polling time, temperature values (0...255)	0 ... 255
The polling time for the external sensor's temperature value is specified here in minutes. In the "0" setting, the external sensor is not automatically polled by the controller. In this case, the sensor must transmit its temperature value itself.	
Cyclical transmission of room temperature (0...255)	0 ... 15 ... 255
This parameter specifies whether and at what time in minutes the determined room temperature is to be periodically output via the "Actual temperature" object.	
Transmission on room temperature change by (0..255 x 0.1 K)	0 ... 3 ... 255
Determines the size of the value change of the room temperature in Kelvin after which the current values are automatically transmitted to the KNX via the "Actual temperature" object. In the 0 setting, the "Transmission on room temperature change by" function is deactivated.	

10.5.2 Object table, room temperature measurement

Objects for room temperature measurement

Funktion: Room temperature measurement

Object no.	Function	Name	Type	DPT	Flag
124	Actual-temperature	Sensor - Output	2 bytes	9,001	C, R, -, T, -
2-byte object for the display of the actual temperature active in the controller (room temperature). The possible temperature range is specified by the received temperature values and corresponds to the range specified by the KNX DPT 9.001. The display can show values between -99.9 and +99.9. The temperature value is always output in the format "°C".					

Funktion: Room temperature measurement

Object no.	Function	Name	Type	DPT	Flag
125	External temperature value	Sensor - Input	2 bytes	9,001	C, (R), W, -, -
2-byte object for coupling an external KNX temperature sensor (e.g. push-button sensor with temperature measurement) for room temperature detection. The possible temperature range is specified by the KNX DPT 9.001. The display can show values between -99.9 and +99.9. The temperature value must always be specified in the format "°C".					

10.6 Temperature setpoints

Setpoint temperature presetting

Setpoint temperatures can be specified for each operating mode ("KNX" controller mode) or for each profile ("Hotel" controller mode) in the ETS as part of configuration. The setpoints can be configured in relative form (derivation from the basic setpoint). The setpoint temperatures can later be adapted during regular operation by KNX communication objects, if desired.

The temperature setpoints are permanently set for the "Frost/heat protection" operating mode ("KNX" controller mode) and for the "Building Protection" profile ("Hotel" controller mode). The temperature setpoint for heating mode (frost protection) is 7 °C and the temperature setpoint for cooling mode (heat protection) is 45 °C.

- i** The setpoint temperatures for the "Frost/heat protection" operating mode cannot be changed in the ETS or adjusted on the device.
- i** The setpoint temperatures for the "Building Protection" profile operating mode cannot be changed in the ETS or adjusted on the device.

When presetting the setpoint temperatures, attention has to be paid to the fact that all setpoints depend on each other as all values are derived from the basic setpoint temperature. Depending on the configured controller mode, either the "Setpoint, Comfort mode, heating" or "Setpoint, Comfort mode, cooling" parameters or the "Setpoint Comfort, heating" or "Setpoint, Comfort, cooling" parameters define the basic setpoint temperature, which is programmed into the device as a specification value during device programming with the ETS. The parameter "Setpoint ... Heating" is visible when the operating modes "Heating" or "Heating and cooling" have been configured. In the "Heating and cooling" operating mode, "Setpoint ... Heating" is specified via parameters. The "Setpoint ... Cooling" is determined by the controller from the "Setpoint ... Heating" and the configured "Deadband between heating and cooling". In the "Cooling" operating mode, the "Setpoint ... Cooling" is specified via parameters.

The setpoint temperatures for the other operating modes or profiles are derived from the basic setpoint temperature.

If the "KNX" controller mode is configured, the setpoint temperatures of the following operating modes are derived from the basic setpoint temperature:

- Standby mode
- Night operation

If the "Hotel" controller mode is configured, the setpoint temperatures of the following profiles are derived from the basic setpoint temperature:

- Comfort-
- Eco
- Standby

The setpoint temperatures are derived from the basic setpoint temperature, taking the parameter "Reduce / increase the setpoint temperature ..." into account depending on the Heating or Cooling operating mode. The deadband will be additionally con-

sidered for the "Heating and cooling" operating mode.

The 2-byte object "Basic setpoint" provides the option of changing the basic setpoint temperature, and thus all the dependent setpoint temperatures during device operation. A change via the object must always be enabled in the ETS by configuring the parameter "Change the basic temperature setpoint via bus" to "Approve". If the basic setpoint adjustment via the bus is disabled, the "Basic setpoint" object will be hidden. The controller rounds the temperature values received via the "Basic setpoint" object to the configured value of the of the setpoint shift (0.5 K, 1.0 K, 1.5 K or 2.0 K).

The temperature setpoints programmed in the room temperature controller by the ETS during commissioning can be changed via communication objects. In the ETS, parameter "Overwrite setpoints in device during ETS programming operation?" on the parameter page "Room temperature control -> RTC - General -> RTC - Setpoints" to define whether the setpoints present in the device, which may have been changed subsequently, are overwritten during an ETS programming operation and are thus replaced again by the values configured in the ETS. If this parameter is "Yes", then the setpoint temperatures are deleted in the device during a programming operation and replaced by the values of the ETS. If this parameter is configured to "No", then setpoints present in the device remain unchanged. The setpoint temperatures entered in the ETS then have no significance.

- i** During initial commissioning of the device the parameter "Overwrite setpoints in device during ETS programming operation?" must be set to "Yes" in order to perform valid initialisation of the memory slots in the device. The setting "Yes" is also necessary if essential controller properties (operating mode, setpoint specification, etc.) are changed in the ETS through new parameter configurations!

Setpoint temperatures for relative setpoint presetting

Depending on the operating mode, different cases should be distinguished when specifying the relative setpoint temperature, which then have an impact on the temperature derivation from the basic setpoint.

Setpoints for operating mode "Heating"

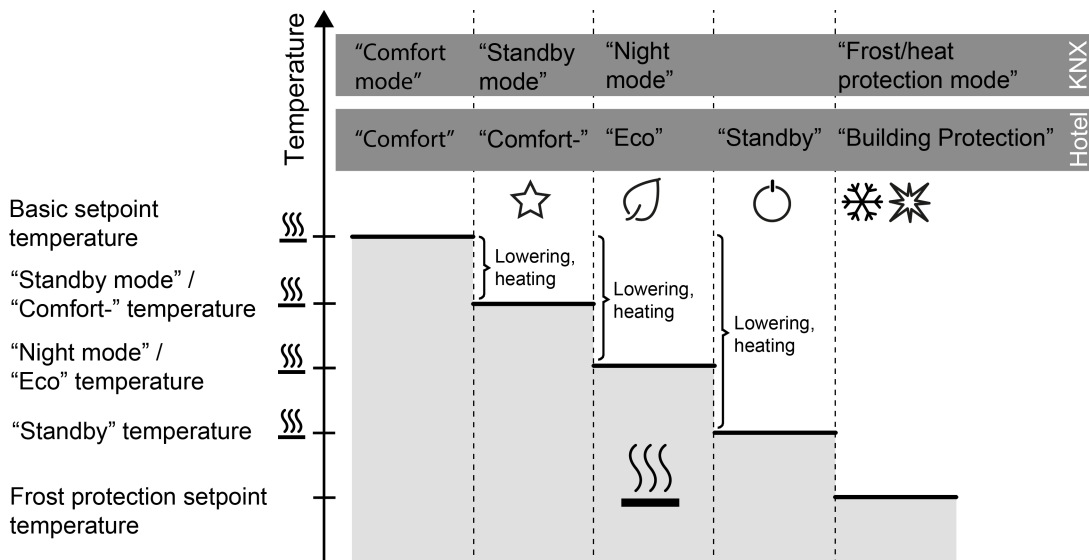

Image 47: Setpoint temperatures in the operating mode "Heating"

In the "KNX" controller mode, the setpoint temperatures for the Comfort, Standby and Night mode exist in this operating mode. The frost protection temperature is set to 7 °C. In the "Hotel" controller mode, the profiles "Comfort", "Comfort-", "Eco" and "Standby" exist in this operating mode. The frost protection temperature is set to 7 °C (see figure 47).

The following applies:

$$T_{\text{"Standby mode" setpoint heating}} \leq T_{\text{"Comfort mode" setpoint heating}}$$

$$T_{\text{"Comfort-" setpoint heating}} \leq T_{\text{"Comfort" setpoint heating}}$$

or

$$T_{\text{"Night" setpoint heating}} \leq T_{\text{"Comfort mode" setpoint heating}}$$

$$T_{\text{"Eco" setpoint heating}} \leq T_{\text{"Comfort" setpoint heating}}$$

or

$$T_{\text{"Standby" setpoint heating}} \leq T_{\text{"Comfort" setpoint heating}}$$

The setpoint temperatures of the "Standby" and "Night" operating modes and the setpoint temperatures of the "Comfort-", "Eco" and "Standby" profiles are derived from the reduction temperatures configured in the ETS from the basic setpoint temperature. The frost protection is supposed to prevent the heating system from freezing. For this reason, the frost protection temperature is set to +7 °C.

Setpoints for the "cooling" operating mode

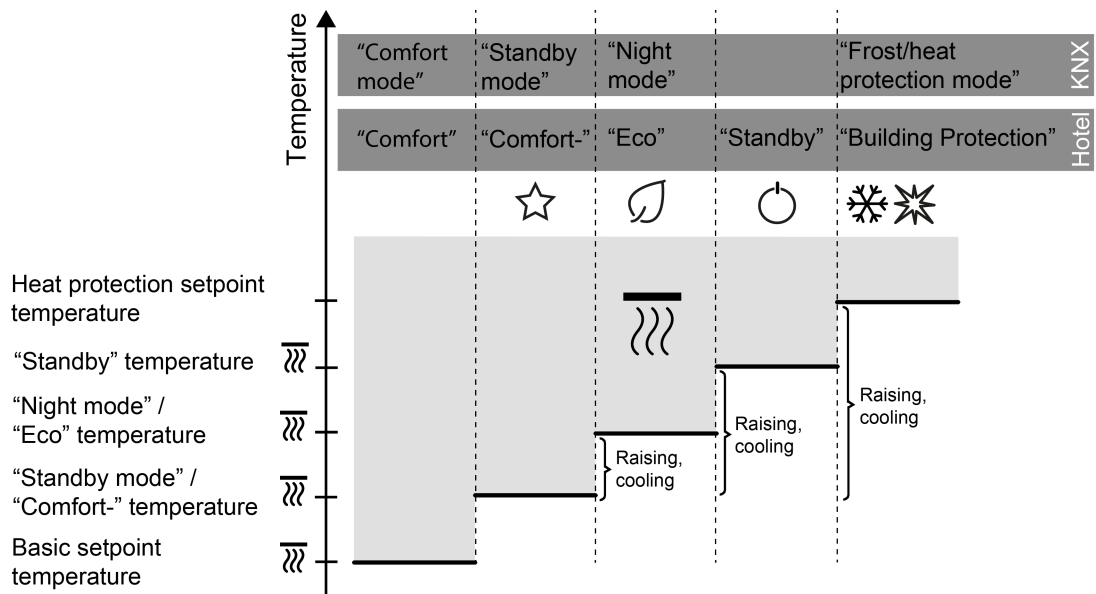

Image 48: Setpoint temperatures in the operating mode "Cooling"

In the "KNX" controller mode, the setpoint temperatures for the Comfort, Standby and Night mode exist in this operating mode. The heat protection temperature is set to 45 °C. In the "Hotel" controller mode, the profiles "Comfort", "Comfort-", "Eco" and "Standby" exist in this operating mode. The heat protection temperature is set to 45 °C (see figure 48).

The following applies:

$$T_{\text{"Comfort mode" setpoint cooling}} \leq T_{\text{"Standby mode" setpoint cooling}}$$

$$T_{\text{"Comfort" setpoint cooling}} \leq T_{\text{"Comfort-" setpoint cooling}}$$

or

$$T_{\text{"Comfort mode" setpoint cooling}} \leq T_{\text{"Night" setpoint cooling}}$$

$$T_{\text{"Comfort" setpoint cooling}} \leq T_{\text{"Eco" setpoint cooling}}$$

or

$$T_{\text{"Comfort" setpoint cooling}} \leq T_{\text{"Standby" setpoint cooling}}$$

The setpoint temperatures of the "Standby" and "Night" operating modes and the setpoint temperatures of the "Comfort-", "Eco" and "Standby" profiles are derived from the reduction temperatures configured in the ETS from the basic setpoint temperature. The heat protection is supposed to ensure that the temperature does not exceed the maximum permissible room temperature in order to protect system components. For this reason, the heat protection temperature is set to +45 °C.

Setpoints for the "heating and cooling" operating mode

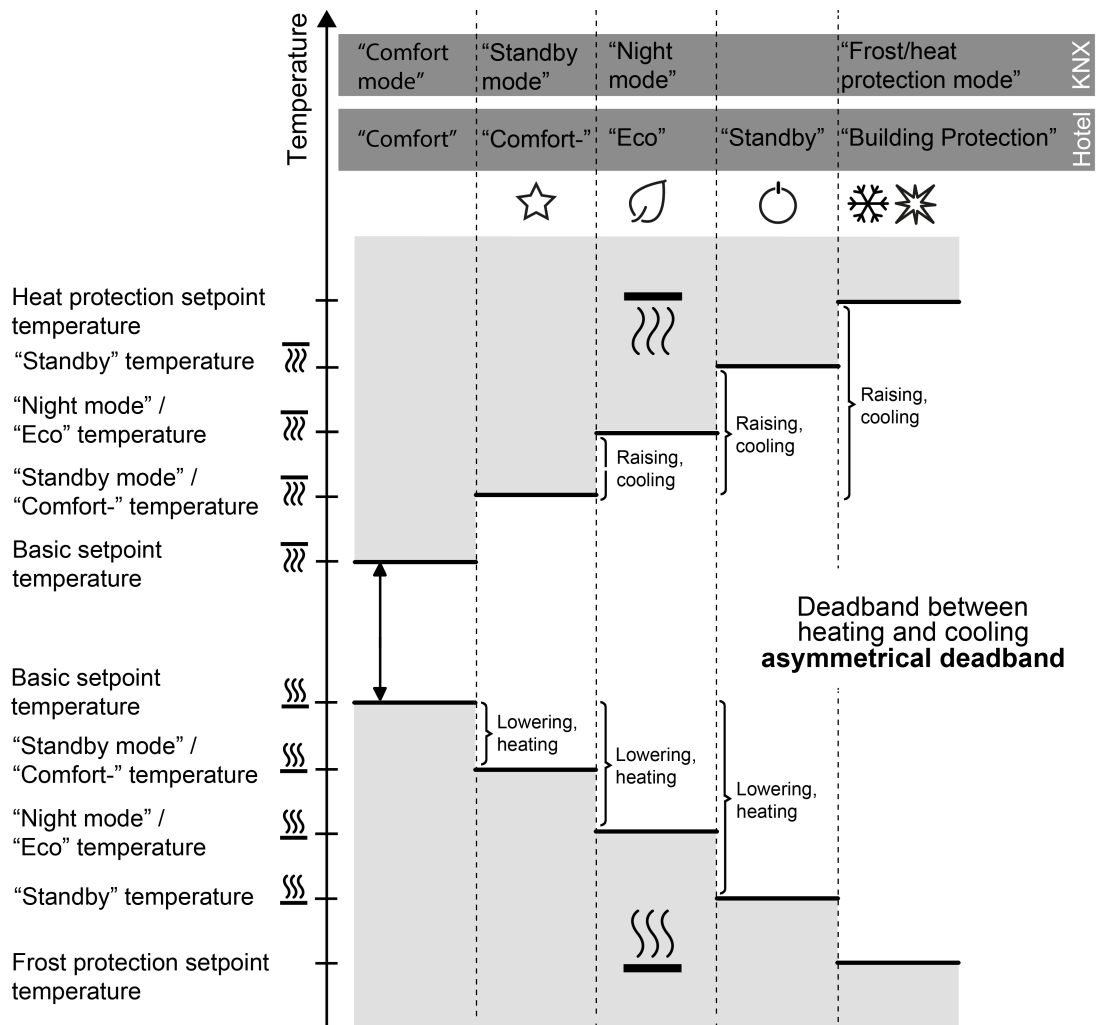

Image 49: Setpoint temperatures in the operating mode "Heating and cooling" with asymmetrical deadband

In this operating mode in the "KNX" controller mode, the setpoint temperatures for the Comfort, Standby and Night modes of both operating modes exist, as well as the deadband. In the "Hotel" controller mode, the "Comfort", "Comfort-", "Eco" and "Standby" profiles of both operating modes exist, as well as the deadband. With combined heating and cooling, an asymmetrical (see figure 49) deadband position is configured. The frost protection and heat protection temperature is configured to 7 °C and 45 °C.

The following applies:

$$T_{\text{"Standby mode" setpoint heating}} \leq T_{\text{"Comfort mode" setpoint heating}} \leq T_{\text{"Comfort" mode setpoint cooling}} \leq T_{\text{"Standby mode" setpoint cooling}}$$

$$T_{\text{"Comfort-" setpoint heating}} \leq T_{\text{"Comfort" setpoint heating}} \leq T_{\text{"Comfort" setpoint cooling}} \leq T_{\text{"Comfort-" setpoint cooling}}$$

or

$$T_{\text{"Night" setpoint heating}} \leq T_{\text{"Comfort mode" setpoint heating}} \leq T_{\text{"Comfort" mode setpoint cooling}} \leq T_{\text{"Night" setpoint cooling}}$$

$$T_{\text{"Eco" setpoint heating}} \leq T_{\text{"Comfort" setpoint heating}} \leq T_{\text{"Comfort" setpoint cooling}} \leq T_{\text{"Eco" setpoint cooling}}$$

or

$$T_{\text{"Standby" setpoint heating}} \leq T_{\text{"Comfort" setpoint heating}} \leq T_{\text{"Comfort" setpoint cooling}} \leq T_{\text{"Standby" setpoint cooling}}$$

The setpoint temperatures of the "Standby" and "Night" operating modes and the setpoint temperatures of the "Comfort-", "Eco" and "Standby" profiles are derived from the reduction temperatures configured in the ETS from the basic setpoint temperature.

The frost protection is supposed to prevent the heating system from freezing. For this reason, the frost protection temperature is set to +7 °C. The heat protection is supposed to ensure that the temperature does not exceed the maximum permissible room temperature in order to protect system components. For this reason, the heat protection temperature should be set to +45 °C.

deadband and deadband positions in the combined heating and cooling operating mode

The setpoint temperatures for Comfort mode ("KNX" controller mode) or for the "Comfort" profile ("Hotel" controller mode) for heating and cooling are derived from the basic setpoint temperature, taking the adjusted deadband into account. The deadband is a temperature zone, in which neither heating nor cooling takes place. It is the difference between the Comfort setpoint temperatures.

The "Deadband between heating and cooling" and "Basic setpoint temperature" parameters are specified in the ETS configuration. One distinguishes between the following settings:

- The deadband preset in the ETS is effective only from the basic setpoint temperature in the direction of "Comfort mode" setpoint temperature or "Comfort mode" for cooling. Thus, the "Comfort mode" or "Comfort" for cooling setpoint temperature is derived directly from the "Comfort mode" setpoint temperature or "Comfort" for heating.

The following applies:

$$T_{\text{Basic setpoint}} = T_{\text{"Comfort mode" setpoint heating}}$$

$$\rightarrow T_{\text{Basic setpoint}} + T_{\text{Deadband}} = T_{\text{Comfort setpoint cooling}}$$

$$\rightarrow T_{\text{"Comfort mode" setpoint cooling}} - T_{\text{"Comfort mode" setpoint heating}} = T_{\text{Deadband}}$$

$$\rightarrow T_{\text{"Comfort mode" setpoint cooling}} \geq T_{\text{"Comfort mode" setpoint heating}}$$

or

$$T_{\text{Basic setpoint}} = T_{\text{"Comfort" setpoint heating}}$$

$$\rightarrow T_{\text{Basic setpoint}} + T_{\text{Deadband}} = T_{\text{Comfort setpoint cooling}}$$

$$\rightarrow T_{\text{"Comfort" setpoint cooling}} - T_{\text{"Comfort" setpoint heating}} = T_{\text{Deadband}}$$

$$\rightarrow T_{\text{"Comfort" setpoint cooling}} \geq T_{\text{"Comfort" setpoint heating}}$$

Accept setpoints permanently

If there is a change in the setpoint temperatures through the "Basic setpoint" communication object, a distinction must be made between two cases, which are set by the parameter

"Permanently apply change to basic temperature setpoint?" ("KNX" controller mode)
or
"Permanently apply change to basic temperature setpoint on profile change? Reset through "Standby" profile." ("Hotel" controller mode)
can be set:

- Case 1: The setpoint adjustment is permanently accepted ("Yes" setting):
If, with this setting, the setpoint temperature is adjusted, the controller saves the value permanently to the permanent storage. The newly adjusted value will overwrite the initial value, i.e. the basic temperature originally configured via the ETS after a reset! The changed values are also retained after a bus voltage failure, after a switchover of the operating mode or after a switchover of the heating/cooling mode.
The "Basic setpoint" object (relative setpoint presetting) is not bidirectional, meaning that a shifted basic setpoint is not signalled back to the KNX.
- i** With a configured "Hotel" controller mode, the basic setpoint temperature is reset to the initial value set in the ETS, if a switchover to the "Standby" profile occurs.
- Case 2: The basic setpoint adjustment is only temporarily accepted ("No" setting):
The setpoints received via the objects remain active only temporarily. In case of a bus voltage failure, after a switchover to another operating mode or the profile, or after a switchover of the heating/cooling mode (e.g. Heating to Cooling), the last setpoint changed will be discarded and replaced by the initial value.

Basic setpoint shifting

In addition to presetting individual setpoint temperature by the ETS or basic setpoint object, the user can shift the basic setpoint in a specific range to predefined limits.

- i** The "Type of setpoint shift" parameter and the 2-byte communication objects (according to KNX DPT 9.002) are only available in the application program Temperature controller fan coil from version 1.2.

Depending on the setting of the parameter "Type of setpoint shift", the shift takes place via the 2-byte communication object "Setpoint shift specification" (acc. to KNX DPT 9.002) or via the 1-byte-communication object "Setpoint shift specification" (acc. to KNX DPT 6.010).

By connecting to this object, the controller extensions are, for example, also able to influence the current setpoint shift of the controller directly in steps. As soon as the controller receives a value, it will adjust the setpoint shift correspondingly. When shifting according to KNX DPT 9.002, the received values are set directly. When shifting according to KNX DPT 6.010 the received values are multiplied by the "Value of the setpoint shift (0.1 K or 0.5 K)" and set accordingly. Values that lie within the possible value range of the basic setpoint shift can be directly jumped to.

The appropriate current setpoint shift is tracked by the controller in the communication object "Current setpoint shift" with a 2-byte or a 1-byte counter value. This object has the same data point type and value range as the object "Setpoint shift specification" (see above). By connecting to this object, suitable controller extensions are also able to display the current setpoint shift and to check the effectiveness of the shift.

Setpoint shift example according to KNX DPT 9.002

As soon as a shift by one offset value in the positive or negative direction is specified, the controller increases or decreases the setpoint value accordingly by the received offset value. A value of "0" means that no setpoint shifting has been adjusted.

Starting situation: Current setpoint temperature = 21.0 °C / Offset value in "Current setpoint shift" = "0" (no active setpoint shift)

- A setpoint shift by a temperature value of 2 K in the positive direction will increase the value in the "Current setpoint shift" object to "2 K".
Current set-temperature = 23.0°C
- An additional setpoint shift by a temperature value of 2 K in the positive direction will again increase the value in the "Current setpoint shift" object by 2 K to "4 K".
Current set-temperature = 25.0°C
- A setpoint shift by a temperature value of 3 K in the negative direction will decrease value in the "Current setpoint shift" object by 3 K to "1 K".
Current set-temperature = 22°C
- An additional setpoint shift by a temperature value of 1.5 K in negative direction will decrease value in the "Current setpoint shift" object by 1.5 K to "-0.5 K".
Current set-temperature = 20.5°C

Setpoint shift example according to KNX DPT 6.010

As soon as a shift by one temperature increment in the positive direction is specified, the controller counts up the value by one digit. The counter value will be counted down by one digit, if there is a negative adjustment of the temperature level. A value of "0" means that no setpoint shifting has been adjusted.

Starting situation: Current setpoint temperature = 21.0 °C / Counter value in "Current setpoint shift" = "0" (no active setpoint shift) / Step width of the setpoint shift = 0.5 K

- A setpoint shift by one temperature increment in the positive direction will count up the value in the "Current setpoint shift" object by one = "1".
Current set-temperature = 21.5°C
- An additional setpoint shift by one temperature increment in the positive direction will again count up the value in the "Current setpoint shift" object by one = "2".
Current set-temperature = 22.0°C

- A setpoint shift by one temperature increment in the negative direction will count down the value in the "Current setpoint shift" object by one = "1".
Current set-temperature = 21.5°C
 - An additional setpoint shift by one temperature increment in the negative direction will again count down the value in the "Current setpoint shift" object by one = "0".
Current set-temperature = 21.0°C
 - An additional setpoint shift by one temperature increment in the negative direction will again count down the value in the "Current setpoint shift" object by one = "-1".
Current set-temperature = 20.5 °C.
- i** The controller monitors the value received via the "Setpoint shift specification" object automatically. As soon as the external preset value exceeds the limits of the adjustment options for the setpoint shift in positive or negative direction, the controller will correct the received value and adjust the setpoint shift to maximum. Depending on the direction of the shift, the value feedback is set to the maximum value via the communication object "Current setpoint shift".
- i** It has to be considered that a shift of the displayed setpoint temperature (temperature offset of the basic temperature) will directly affect the basic setpoint and as a result shift all other temperature setpoints.
A positive shift is possible up to the heat protection temperature. A negative shift is possible up to the frost protection temperature.
- i** The "Basic setpoint" object is not bidirectional, meaning that a shifted basic setpoint is not signalled back to the KNX.

Whether a basic setpoint shift in the "KNX" controller mode only affects the currently active operating mode or whether it influences all other setpoint temperatures of the remaining operating modes is determined by the "Permanently apply change to basic setpoint shift" parameter in the "Room temperature control -> RTC - General -> RTC - Setpoints" parameter page:

- "No" setting:
The basic setpoint shift carried out is in effect for only as long as the operating mode or heating/cooling mode has not changed or the basic setpoint is maintained. Otherwise the setpoint shift will be reset to "0".
- "Yes" setting:
In general, the shifting of the basic setpoint carried out affects all operating modes. The shift is maintained even after a switchover of the operating mode or the heating/cooling mode or adjusting the basic setpoint.

Whether a basic setpoint shift in the "Hotel" controller mode is permanently applied on changing from the "Comfort" or "Comfort-" profile to the "Eco" profile is determined by the "Permanently apply change to basic setpoint shift on Comfort -> Eco profile change" parameter in the "Room temperature control -> RTC - General -> RTC - Setpoints" parameter page:

- "No" setting:
On switching over the profile from "Comfort" or "Comfort-" to "Eco" or "Standby", the shift of the basic setpoint is rejected.
 - "Yes" setting:
In general, the shifting of the basic setpoint carried out affects the "Comfort", "Comfort-" and "Eco" profiles. The shift is maintained even after a switchover of the profile or the operating mode or adjusting the basic setpoint. On switching over to the "Standby" profile, the shift of the basic setpoint is rejected.
- i** In the "Hotel" controller mode, the setpoint shift is always applied on a profile switchover from "Comfort" to "Comfort-".
 - i** In the "Hotel" controller mode, the setpoint shift never affects the "Standby" and "Building Protection" profiles.
 - i** In the "Hotel" controller mode, a switchover to the "Standby" profile causes a reset of the user settings. These include the setpoint shift and the change of the basic setpoint.
 - i** Since the value for the basic setpoint shift is stored exclusively in volatile memory, the shift will get lost in case of a bus voltage failure or an ETS programming operation.
 - i** A setpoint shift does not affect the temperature setpoints for frost or heat protection!
 - i** To ensure that controller extensions display the correct shifts and also activate the functions of the main controller correctly, it is necessary for the controller extensions to be set to the same shift limits and value of the setpoint shift as the main unit. Observe the documentation of the controller extension!

Transmitting the setpoint temperature

The setpoint temperature specified for the active operating mode ("KNX" controller mode) or for the active profile ("Hotel" controller mode), which is specified for the active operating mode, can be actively transmitted to the bus via the 2-byte "Setpoint temperature" object. The parameter "Send on setpoint temperature change by" in the "Room temperature control -> RTC - General -> RTC - Setpoint values" parameter node specifies the temperature value by which the setpoint has to change in order to have the setpoint temperature value transmitted automatically via the object. Possible temperature value changes lie within a range of 0.1 K and 25.5 K. The setting "0" at this point will deactivate the automatic transmission of the setpoint temperature.

In addition, the setpoint can be transmitted periodically. The "Cyclical transmission of setpoint temperature" parameter determines the cycle time (1 to 255 minutes). The value "0" will deactivate the periodical transmission of the setpoint temperature value. It has to be pointed out that with deactivated periodical transmission and deactivated automatic transmission, no setpoint temperature telegrams will be transmitted in case of a change.

Setting the "Read" flag on the "Setpoint temperature" object makes it possible to read

out the current setpoint. After a bus voltage return or after programming via the ETS, the object value will be initialised according to the current setpoint temperature and actively transmitted to the bus.

Limitation of the setpoint temperatures in cooling mode

In accordance with statutory requirements in Germany and elsewhere, the temperature at the workplace should be a maximum of 26 °C, or at least 6 K below outdoor temperatures of 32 °C. Exceeding these limits is only permissible in exceptional circumstances. To meet these requirements, the room temperature controller offers a setpoint temperature limit, which is only effective in cooling mode. If necessary, the controller limits the setpoint temperature to specific values and prevents an adjustment beyond the limits.

The "Setpoint temperature limit in cooling mode" parameter in the "Room temperature control -> RTC - General -> RTC - Setpoints" parameter node can activate the limit and specify its function. The following settings are possible:

- Setting "Only difference to outdoor temperature"
In this setting, the outdoor temperature is monitored and compared to the active setpoint temperature. The desired maximum temperature difference to the outdoor temperature can be specified in the range between 1 K and 15 K. The specification is made using the "Difference to outdoor temperature in cooling mode" parameter. The value can be set in step widths of 1 K.
If the outdoor temperature rises above 32 °C in the sense of the statutory requirements, then the controller activates the setpoint temperature limit. It then permanently monitors the outdoor temperature and raises the setpoint temperature so that it is beneath the outdoor temperature by the amount configured. Should the outdoor temperature continue to rise, the controller raises the setpoint temperature until the required difference to the outdoor temperature is achieved. It is then not possible to undershoot the raised setpoint, e.g. by changing the basic setpoint change.
The change to the setpoint temperature limit is temporary. It only applies for as long as the outdoor temperature exceeds 32 °C.
With the setpoint temperature limit, the configured temperature difference relates to the setpoint temperature of the Comfort mode for cooling. In other operating modes, the temperature distance to Comfort mode must be taken into account.

Example:

In the ETS, the difference to the outdoor temperature is set to 6 K. The Standby setpoint temperature is configured to 2 K higher than the Comfort setpoint temperature. The result of this is that, for command value limiting, the setpoint temperature in Standby mode may only be a maximum of 4 K below the outdoor temperature. The setpoint temperature limit applies to Night mode in the same way.

-  The automatic setpoint temperature raising by the setpoint temperature limit goes only as far as the configured heat protection temperature. Therefore the heat protection temperature can never be exceeded.

- i** A basic setpoint shift never affects an active setpoint temperature limit with differential measurement to the outdoor temperature. In this case, the setpoint temperature limit only works with the unshifted basic setpoint. A setpoint shift active before the limitation is restored after the limitation, if it was not reset in another way, e.g. by an operating mode switchover.
- Setting "Only max. setpoint temperature"
In this setting, no setpoint temperatures are permitted in Cooling mode related to the Comfort, Standby and Night modes, which are greater than the maximum setpoints configured in the ETS. The maximum setpoint temperature is specified in the "Max. setpoint temperature in Cooling mode" parameter and can be configured within the limits 20 °C to 35 °C in 1 °C steps.
With an active limit, no larger setpoint can be set in cooling operation, e.g. by a basic setpoint change or a setpoint shift. However, heat protection is not influenced by the setpoint temperature limit.
The maximum setpoint temperature configured in the ETS generally relates to the Comfort setpoint temperature of Cooling mode. In other operating modes, the temperature distance to Comfort mode must be taken into account. Example...
The maximum setpoint temperature is configured to 26 °C. The Standby setpoint temperature is configured to 2 K higher than the Comfort setpoint temperature. The result of this is that, for command value limiting, the setpoint temperature in Standby mode is limited to 28 °C. The setpoint temperature limit applies to Night mode in the same way.
 - Setting "Max. setpoint temperature and difference to outdoor temperature"
This setting is a combination of the two above-mentioned settings. In the downward direction, the setpoint temperature is limited by the maximum outdoor temperature difference, whilst in the upward direction, the limit is made by the maximum setpoint.
The maximum setpoint temperature has priority over the outdoor temperature difference. This means that the controller keeps on raising the setpoint temperature upwards according to the difference to the outdoor temperature configured in the ETS until the maximum setpoint temperature or the heat protection temperature is exceeded. Then the setpoint is limited to the maximum value.

A setpoint limit enabled in the ETS can be activated or deactivated as necessary using a 1-bit object. For this, the "Activation of the setpoint temperature limit via object in cooling mode" parameter can be set to "Yes". In this case, the controller only takes the setpoint limit into account, if it has been enabled via the object "Cooling setpoint temperature limit" ("1" telegram). If the limitation is not enabled ("0" telegram), the cooling setpoint temperatures are not limited.

After a device reset (bus voltage return, ETS programming operation), the object value is "0", meaning that the setpoint limit is inactive.

- i** The setpoint limit has no function in Heating mode.

10.7 Command value and status output

Command value objects

Depending on the control algorithm selected for the heating and/or cooling mode, the format of the command value objects is also specified. 1 bit or 1 byte command value objects can be created in the ETS. The control algorithm calculates the command values in intervals of 30 seconds and outputs them via the objects. With the pulse width-modulated PI control (PWM) the command value is updated, if required, solely at the end of a PWM cycle.

Possible object data formats for the command values separately for both operating modes are:

- continuous PI control: 1 byte
- Switching PI control: 1 bit + additionally 1 byte (for example for the status indication with visualisations),

Depending on the set heating/cooling operating mode, the controller is able to address heating and / or cooling systems, to determine command values and to output them via separate objects. One distinguishes between two cases for the "heating and cooling" mixed-mode:

- Case 1: Heating and cooling system are two separate systems
In this case, the "Transmit heating and cooling command value to one common object" parameter should be set to "no" in the "Room temperature control -> RTC - General" parameter node. Thus, there are separate objects available for each command value, which can be separately addressed via the individual systems.
This setting allows to define separate types of control for heating and cooling.
- Case 2: Heating and cooling system are a combined system
In this case, the "Transmit heating and cooling command value to one common object" parameter may be set, if required, to "yes". This will transmit the command values for heating and cooling to the same object.
With this setting it is only possible to define the same type of feedback control for heating and for cooling as the feedback control and the data format must be identical. The ("Type of heating / cooling") control parameter for cooling and heating still has to be defined separately.
A combined command value object may be required, for example, if heating as well as cooling shall take place via a single-pipe system (combined heating and cooling system). For this, the temperature of the medium in the single-pipe system must be changed via the system control. Afterwards the heating/cooling operating mode is set via the object (often the single-pipe system uses cold water for cooling during the summer, hot water for heating during the winter).

If required, the actuating variable can be inverted before output. With output via a combined object, the parameters "Output of heating command value", "Output of cooling command value" or "Output of command values..." output the command value in inverted fashion according to the object data format.

The following applies:

For continuous command values:

-> not inverted: Command value 0 % ... 100 %, value 0 ... 255

-> inverted: Command value 0 % ... 100 %, value 255 ... 0

For switching command values:

-> not inverted: Command value off / on, value 0 / 1

-> inverted: Command value off / on, value 1 / 0

Automatic transmission

On automatic transmission of the command value telegrams, a distinction is made with regard to the type of control:

- Continuous PI control:

In case of a continuous PI control, the room temperature controller calculates a new command value periodically every 30 seconds and outputs it to the bus via a 1-byte value object. The change interval of the command value can be determined in percent according to which a new command value is to be output on the bus via the "Automatic transmission on change by..." parameter in the "Room temperature control -> RTC - General -> RTC - Command values and status output" parameter node. The change interval can be configured to "0" so that a change in the command value will not result in an automatic transmission.

In addition to the command value output following a change, the current command value value may be periodically transmitted. In addition to the times when changes are to be expected, other command value telegrams will be output according to the active value after a configurable cycle time. This ensures that, during cyclical security monitoring of the command value in valve drive or in the addressed switch actuator, telegrams are received within the monitoring time. The time interval predetermined by the "Cycle time for automatic transmission..." parameter should be smaller than the monitoring time in the activated actuator (cycle time in the controller < monitoring time in the actuator). The "0" setting will deactivate the periodic transmission of the command value.

With continuous PI control it must be noted that if the cyclical and the automatic transmission are both deactivated, no command value telegrams will be transmitted in case of a change!

- Switching PI control (PWM):

In case of a switching PI control (PWM), the room temperature controller calculates a new command value internally every 30 seconds. With this control, however, the update of the command value takes place, if required, solely at the end of a PWM cycle. The parameters "automatic transmission on change by..." and "Cycle time for automatic transmission..." are not enabled with this control algorithm. The parameter "Cycle time of the switching command value..." defines the cycle time of the PWM command value signal.

Command value limit

Optionally a command value limit can be configured in the ETS. The command value limit allows the restriction of calculated command values to the range limits "minimum" and "maximum". The limits are permanently set in the ETS and, if command value limitation is active, can be neither undershot or exceeded during device operation. If available, it is possible to specify various limiting values for heating and cooling.

- i** It should be noted that the command value limit has no effect with "Transmitting of command values for heating and cooling via a common object"! In that case it is still possible to configure the command value limit in the ETS, but it will have no function.

The "Command value limit" parameter on the parameter page "Room temperature control -> RTC - General -> RTC command values and status output" defines the mode of action of the limiting function. The command value limit can either be activated or deactivated using the 1-bit communication object "Command value limit", or be permanently active. When controlling via the object, it is possible to have the controller activate the command value limit automatically after bus voltage return or an ETS programming operation. Here the "Command value limit after reset" parameter defines the initialisation behaviour. In the "Deactivated" setting, the command value limit is not automatically activated after a device reset. A "1" telegram must first be received via the "Command value limit" object for the limit to be activated. In the "Activated" setting, the controller activates the command value limit automatically after a device reset. To deactivate the limit a "0" telegram must be received via the "Command value limit" object. The limit can be switched on or off at any time using the object.

With a permanently active command value limit, the initialisation behaviour cannot be configured separately after a device reset, as the limit is always active. In this case it is also not possible to configure any object.

As soon as the command value limit is active, calculated command values are limited according to the limiting values from the ETS. The behaviour with regard to the minimum or maximum command value is then as follows...

- Minimum command value:
The "Minimum command value" parameter specifies the lower command value limiting value. The setting can be made in 5 % increments in the range 5 % ... 50 %. With an active command value limit, the set minimum command value is not undershot by command values. If the controller calculates smaller command values, it sets the configured minimum command value. The controller transmits a 0% command value if no more heating or cooling energy has to be demanded.
- Maximum command value:
The "Maximum command value" parameter specifies the upper command value limiting value. The setting can be made in 5 % increments in the range 55 % ... 100 %. With an active command value limit, the set maximum command value is not exceeded. If the controller calculates larger command values, it sets the configured maximum command value.

If the limit is removed, the device automatically repositions the most recently calculated command value to the unlimited values when the next calculation interval for the command values (30 seconds) has elapsed.

- i** An active command value limit has a negative effect on the control result when the command value range is very restricted. A control deviation must be expected.

Controller status

The room temperature controller can transmit its current status to the KNX. A choice of data formats is available for this. The "Controller status" parameter in the "Room temperature control -> RTC - General -> RTC - Command value and status output" parameter branch will enable the status signal and set the status format...

"KNX compliant"

The KNX-compliant controller status feedback is harmonised on a manufacturer-independent basis and consists of multiple communication objects. The 2-byte object "KNX status" (DPT 22.101) indicates elementary functions of the controller.

Bit of the status telegram	Meaning
0	Controller error status ("0" = no error / "1" = error)
1	not used (permanent "0")
2	not used (permanent "0")
3	not used (permanent "0")
4	not used (permanent "0")
5	not used (permanent "0")
6	not used (permanent "0")
7	not used (permanent "0")
8	Operating mode ("0" = Cooling / "1" = Heating)
9	not used (permanent "0")
10	not used (permanent "0")
11	not used (permanent "0")
12	Controller disabled (dew point operation) ("0" = Controller enabled / "1" = Controller disabled)
13	Frost alarm ("0" = Frost protection temperature exceeded / "1" = frost protection temperature undershot)
14	Heat alarm ("0" = heat protection temperature exceeded / "1" = Heat protection temperature exceeded)
15	not used (permanent "0")

Bit encoding of the 2-byte KNX-compliant status telegram ("KNX status" object)

In the "KNX" controller mode, the "KNX Status" object is supplemented by the objects "KNX status operating mode" and "KNX status forced operating mode". In addition, the controller makes the 1-byte object "Currently active operating mode" available.

The "Hotel" controller also contains the 2-byte object "KNX Status" (DPT 22.101). In this controller mode, the object is replaced by the objects "KNX status profile", "Status Standby profile", "KNX status forced profile" and "Status forced profile switchover Standby". In addition, the controller makes the objects "Currently active profile" and "Currently active profile standby" available.

- i** In the "KNX" controller mode, the device then shows the actually set operating mode on the display. The actually set operating mode is transmitted to the bus via the "Currently active operating mode" object. The "KNX operating mode status" also sends its status to the bus after an operating mode switchover. Depending on the status of the presence, window and forced operating mode, the "KNX operating mode status" may deviate from the currently active operating mode.
- i** In the "Hotel" controller mode, the device then shows the actually set profile on the display. The actually set profile is transmitted to the bus using the "Currently active profile" and "Currently active Standby profile" objects. After a profile switchover, the "KNX status profile" and "Status Standby profile" objects also send their status to the bus. Depending on the status of the presence, window and forced profile, the status may deviate from the currently active profile.

Actually set operating mode	Display icon	"Currently active operating mode" object value
Comfort mode	No icon	01
Standby mode	☆	02
Night operation	🌀	03
Frost/heat protection mode	🔌	04

Encoding of the object "Currently active operating mode" in the "KNX" controller mode

Actually set profile	Display icon	Object value "Currently active profile"	Object value "Currently active profile standby"
Comfort	No icon	01	X
Comfort-	☆	02	X
Eco	🌀	03	00
Standby	🔌	03	01
Building Protection	❄️❄️	04	X

X Status irrelevant

Encoding of the objects "Currently active profile" and "Currently active profile standby" in the "Hotel" controller mode

"Controller general"

The general controller status collects essential status information of the controller in three communication objects. The "Controller status" object contains fundamental status information. The "Status signal addition" object collects in a bit-orientated manner further information that is not available via the "Controller status" object. The object "Currently active profile standby" is an additional 1-bit object, using which the controller differentiates the current profile between Eco and Standby ("1" = "Standby" profile; "0" = "Eco" profile). For example, controller extensions can evaluate the additional status information, in order to be able to display all the necessary controller status information on the extension display.

Bit of the status telegram	Meaning in "KNX" controller mode	Meaning in "Hotel" controller mode
0	On "1": Comfort operation activated	On "1": "Comfort" active
1	On "1": Standby mode active	On "1": "Comfort" active
2	On "1": Night mode active	On "1": "Eco" active
3	On "1": Frost/heat protection mode active	On "1": "Building Protection" active
4	On "1": Controller disabled	On "1": Controller disabled
5	On "1": Heating, on "0": Cooling	On "1": Heating, on "0": Cooling
6	On "1": Controller inactive (dead-band)	On "1": Controller inactive (dead-band)
7	On "1": Frost alarm ($T_{\text{Room}} \leq +5 \text{ }^\circ\text{C}$)	On "1": Frost alarm ($T_{\text{Room}} \leq +5 \text{ }^\circ\text{C}$)

Bit encoding of the 1 byte status telegram

Bit of the status telegram	Meaning on "1"	Meaning on "0"
0	Operating mode/Normal profile	Operating mode/Forced profile
1	not used (permanent "0")	not used (permanent "0")
2	Presence (Presence detector)	No presence (Presence detector)
3	not used (permanent "0")	not used (permanent "0")
4	Window opened	No window opened
5	not used (permanent "0")	not used (permanent "0")
6	Heat protection active	Heat protection inactive
7	Controller disabled (dew point operation)	Controller not disabled

Bit encoding of the 1 byte additional status telegram

- i** Upon a reset, the status objects will be updated after the initialisation phase. After this, updating is performed cyclically every 30 seconds in parallel with the command value calculation of the controller command values. Telegrams are only transmitted to the bus when the status changes.

Special case for command value 100% (Clipping mode)

If with a PI control the calculated command value of the controller exceeds the physical limits of the actuator, in other words if the calculated command value is greater than 100%, then the command value is set to the maximum value (100%) and thus limited. This special, necessary control behaviour is also called "clipping". With PI control the command value can reach the value "100%" if there is a large deviation of the room temperature from the setpoint temperature or the controller requires a long time to adjust to the setpoint with the heating or cooling energy that is being applied. The controller evaluates this state in a particular manner.

The controller maintains the maximum command value only as long as it is necessary. After that, it adjusts the command value downwards according to the PI algorithm. The advantage of this control characteristic is the fact that the room temperature does not exceed the setpoint temperature at all, or only slightly. It should be mentioned that this necessary control principle increases the tendency to oscillate about the setpoint.

- i** Clipping may also occur when a command value limit is active (maximum command value). In this case, if the internally calculated command value reaches 100%, then the controller only transmits to the bus the maximum command value according to the ETS configuration.

Rotation angle conversion

- i** The "Rotation angle conversion" parameter and the 2-byte communication objects (according to KNX DPT 9.020) are only available in the application program Temperature controller fan coil from version 1.2.

In the ETS, it is possible to optionally convert a command value output of the room temperature controller function of the device to a control parameter for a rotation angle of a rotary actuator.

The prerequisite for converting the control value is that the room temperature controller operating mode is set to "Heating and cooling".

The "heating" and "cooling" command values of the controller function are converted to a rotary angle for activating a rotary actuator. This in turn, for example, moves a rotary valve.

From a technical point of view, the controller command value of the device is converted to a 2-byte control parameter (maximum 0...25.5 V), (typical 0...10 V), which corresponds to the rotary angle for a rotary actuator. This control parameter is transmitted to the KNX bus, for example, received from an analog output and converted. The rotary actuator adjusts the rotary angle transmitted to it. It is mechanically connected, for example, to a 6-way rotary valve.

The voltage values corresponding to the angular openings of the rotary valve for heating and cooling can be taken from the valve characteristic curve.

If the rotation angle conversion is enabled, the room temperature controller function continues to work unchanged. Even the communication objects of the controller remain unchanged. Additionally, the conversion of the controller command value for heating and cooling is carried out in one rotary angle. This determined rotary angle receives its own object for activating a rotary actuator.

The rotary valves have different characteristic curves. Therefore, the voltage values that the controller is to send must be adapted to the type of rotary valve. The minimum and maximum values for heating and cooling are important here. In the dead zone in which neither heating nor cooling is taking place, the object of the rotary angle retains the value for 0% of the current operating mode (heating or cooling). The following diagrams and tables show the values for the two valve types Belparts DXN6P25B and Swegon cco kit as examples

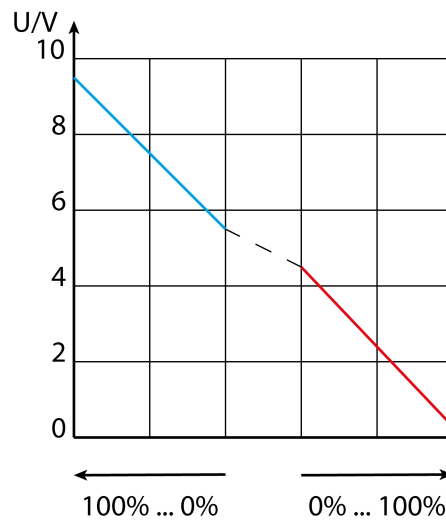

Image 50: Valve characteristic, example Belparts

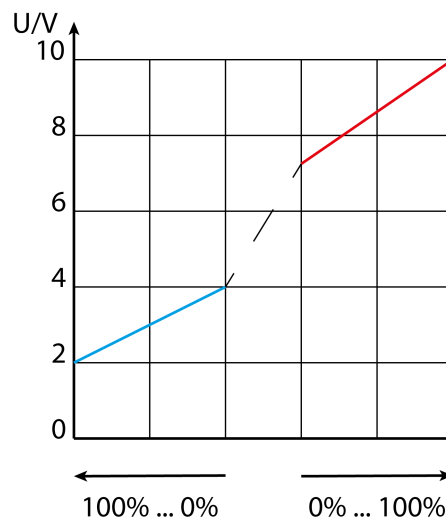

Image 51: Valve characteristic, example Swegon

	Belparts DXN6P25B	swegon cco kit
--	-------------------	----------------

Parameters	Voltage / V	Voltage / V
Maximum heating	0.5	10.0
Minimum heating	4.5	7.2
Minimum cooling	5.5	4.1
Maximum cooling	9.5	2.0

Table 1: Settings for Belparts DXN6P25B and swegon cco kit

Immediately after processing the room temperature controller function (every 30 seconds), the conversion is carried out if the rotary angle output was enabled in the parameters of the database. The controller operating mode (heating and cooling) and the current command value as well as the configured voltage values are included in the calculation of the rotary angle to be set. The voltage values of the angle of rotation conversion are only sent in the event of a change.

10.8 Fan controller

Introduction

The room temperature control can be supplemented with a fan controller. This makes it possible to control the fan from heating and cooling systems operated by circulating air, such as fan coil units (FanCoil units), depending on the command value calculated in the controller or using manual operation. Fan control is always enabled. Fan control can be configured on the parameter page "Room temperature control -> Controller general -> Fan control". The fan control distinguishes between automatic and manual operation.

The  icon is visible in the display.

In Comfort mode ("KNX" controller mode) or in the "Comfort" profile ("Hotel" controller mode), both manual operation and automatic operation can be activated via the sensor buttons. In addition, the fan level can be adjusted in manual operation using the sensor buttons.

In the "Standby" and "Night" operating modes ("KNX" controller mode) and in the "Comfort-", "Eco" and "Standby" profiles, the sensor buttons have no influence on fan control. The fan control function method for this energy level can be configured in the parameters of the ETS. The "Fan control ..." parameters on the parameter page "RTC - Fan control" configure fan control for the operating modes "Standby operation" and "Night operation" and for the "Comfort-", "Eco" and "Standby" profiles. If menu level 2 is enabled, then these settings can be adjusted at a later time menu level 2.

In Frost/heat protection operation ("KNX" controller mode) or in the "Building Protection" profile ("Hotel" controller mode), the function is permanently set to automatic.

After a device reset, the device switches to an operating mode or a profile, depending on the parameters ("Operating mode after reset" or "Profile after reset"). The setting of the "Fan control ..." parameters in combination with the "Operating mode/pro-

file after reset" configures fan control after a device reset. Fan control is in automatic mode, if the "Operating mode after reset" or "Profile after reset" is set to "Comfort mode".

Operating mode and fan levels

Depending on the operating mode of the room temperature control, as configured in the ETS (siehe Kapitel "Operating modes and operating mode change-over" ▶ Page 47), various controller command values can be used as the basis for fan control. The "Operating mode" parameter specifies which command value of the controller controls fan control.

Fan coil units are as a rule equipped with filters, and have multi-level blowers whose speed and thus ventilation output can be varied by means of fan level inputs. For this reason, the fan controller of the room temperature controller supports up to 3 fan level outputs, for which the actually used number of levels (1...3) is set using the "Number of fan levels" parameter.

The controller controls the levels of a fan using bus telegrams. Usually, the fan level telegrams are received and evaluated by simple switching actuators. The electrical control of the fan level inputs of a fan coil unit takes place via these actuators. Depending on the data format of the objects of the controlled actuators, the switchover between the fan levels can either take place via up to 3 separate 1-bit objects or, alternatively, via one 1-byte object. The "Fan level change-over via" parameter defines the data format of the objects to output the fan level.

Fan level	Object value
Fan OFF	0
1	1
2	2
3	3

Table 11: Value meaning for 1 byte fan level object

Due to fan motors' inertia, as a rule there is a limit to how short the time intervals for switching the fan levels can be, i.e. there is a limit to how quickly the fan speed can be varied. Often the technical information for a fan coil unit specifies change-over times that the fan controller must maintain for each fan level change-over. The change-over direction, i.e. whether the level is being increased or decreased, does not play any role here.

With a change-over via the 1-bit objects, when the fan level is changed by the controller, the active fan level is first switched off before the new level is switched on. If the fan controller is working in automatic mode, the settable "Waiting time on level change-over" is maintained on change-over of the levels. For this short time, the fan level objects all receive the status "0 - Fan off". A new level is only then switched on when the waiting time has elapsed. Only one fan level output is ever switched on (changeover principle).

With change-over via the 1-byte object, on changing the fan level, the change-over takes place directly into the new level, without setting the "OFF" status. If the fan controller is working in automatic mode, the settable "Waiting time on level change-

over" (dwell time) is always taken into account before change-over of the levels. With rapid level change-over, the change to the new level only takes place once the waiting time has elapsed.

- i** The change from OFF to level 1 always takes place immediately, without a waiting time. An optionally-configured switch-on level is applied directly.
- i** In manual mode, the "Waiting time on level change-over" is only significant for the switch-on level (Start-up via level). Here, the fan levels can be switched over without a delay through manual operation.
- i** When changing from manual operation to automatic operation, the waiting time is taken into account in the case of a connected level change.

In Comfort mode or with the "Comfort" profile active, the active fan level is shown in the display of the device by the fan icon and the current status of the fan level.

Fan control status - Display









State of the fan control	Status display on the display
Automatic operation, Fan level OFF	AUTO  □□□
Automatic operation, Fan level 1	AUTO  ■□□
Automatic operation, Fan level 2	AUTO  ■■□
Automatic operation, Fan level 3	AUTO  ■■■
Manual operation, Fan level OFF	OFF  □□□
Manual operation, Fan level 1	LOW  ■□□
Manual operation, Fan level 2	MID  ■■□
Manual operation, Fan level 3	HIGH  ■■■

Image 52: Fan control status in the display

- i** The fans of a fan coil unit are - as described above - controlled by the fan level objects of the controller. The electromechanical valves for heating and/or cooling, integrated into the blower devices, can be controlled via suitable switching actuators using the objects "Heating message" or "Cooling message" (siehe Kapitel "Operating modes and operating mode change-over" ▶ Page 48).
- i** The 1-byte object "Ventilation visualisation" can, if necessary, also be evaluated by other bus devices (e.g. visualisation - panel / PC software). It always transmits the current fan level as a 1-byte value, either automatically on a change or passively on reading out.
- i** The objects of the fan levels are only updated by the controller. These objects may not be written to by other bus subscribers. Reading out is possible.
- i** After a device reset, the fan level objects and the visualisation object are updated and the status transmitted to the bus.

Automatic operation / manual operation

The fan control distinguishes between automatic and manual operation. The switchover between the two operation modes takes place using the 1-bit object "Ventilation, auto/manual", in menu level 2 or using the sensor buttons in the operating level.

The parameter "Interpretation object fan control automatic/manual" in the fan control parameter group defines with which switching value the automatic or manual operation is set via the communication object.

- i** The "Ventilation, auto/manual" object transmits actively ("Transmit" flag set). When the operating mode is changed over using local control, the valid status is transmitted to the bus.
- i** Updates to the object value "Automatic mode active" -> "Automatic mode active" or "Manual mode active" -> "Manual mode active" do not produce any reaction.

Automatic mode:

The command value of the controller is used internally in the device for automatic control of the fan levels. As a transition between the levels, there are threshold values, defined according to the command value of the controller, which can be set using parameters in the ETS. If the command value reaches the threshold value of a level during an increase of the command value, the appropriate level is activated. If the command value reaches below a threshold value, minus the configured hysteresis, during a reduction of the command value, then the switchover takes place into the next lowest fan level. The hysteresis value applies to all the threshold values. The threshold values for the individual fan levels can be configured freely in the range from 1 ... 100 %. The threshold values are not checked for plausibility in the ETS, meaning that incorrect configuration is possible. For this reason, it must be ensured that the threshold values, compared to the level value, are configured in a rising direction (level 1 threshold value > level 2 threshold value > level 3 threshold value).

When the command value changes, and thus the fan level, it is only possible to switch directly into neighbouring levels (exception: switch-on level). Thus, in Automatic operation, it is only possible, for example, to switch from level 2 down to level 1 or up to level 3. If the command value change exceeds or undershoots the threshold values of multiple fan levels, then, starting with the current fan level, all the fan levels are activated in succession until the fan level specified by the command value is reached.

If the fan is switched off by the automatic system, then it runs on for the time configured as "Fan run-on time, heating" or "Fan run-on time, cooling", providing that these run-on times are configured in the ETS.

- i** In automatic mode, the fan level objects are updated according to the internal command value calculation (cyclically every 30 seconds) plus the waiting time configured for level change-over. Telegram transmission only takes place when the object values of the fan levels are changed. After a device reset, the fan level objects are updated and the status transmitted to the bus.

- i** The timer starts the waiting time as soon as a threshold value is exceeded or not reached. The device only switches the fan level automatically when the waiting time has elapsed.
- i** If a switch-on level is configured in the ETS ("Start-up via level" parameter), then, before the automatic activation of a fan level, it is possible to switch to a level, specified in the ETS and usually higher, for a brief time according to the command value (see section "Switch-on level").
- i** The command value evaluated by the fan controller in Automatic mode can be optionally limited by in the top and bottom command value ranges by the parameters "Command value is 0% until internal command value is greater than" and "Command value is 100% as soon as internal command value is greater than". In addition, the command value can also be raised by a constant value by the "Command value offset" parameter Controller function - Fan control - Command value limit values and command value offset (siehe Kapitel "Fan controller" ▶ Page 100).

Manual operation:

With the actuation of sensor buttons configured to the local "Manual control" function (T2.1 or T2.2) on the device, the controller makes a distinction as to whether it was in automatic or manual mode at the time the button was pressed.

If the controller is in automatic mode, then pressing a button switches to manual mode. The fan level remains intact on switching to manual operation.

If, at the time the button is pressed, the manual controller is already active, then the controller switches to the next highest (∧) or next lowest (∨) fan level without a delay. If the fan is at the highest level, any further actuation of the sensor button (∧) has no effect.

If the fan is switched off manually from the highest level, then it runs on for the time configured as "Fan run-on time, heating" or "Fan run-on time, cooling", providing that these run-on times are configured in the ETS. If, during the run-on time, the manual control button is pressed again, the controller will terminate the run-on time. The fan switches off briefly and then switches immediately to level 1.

In fan control in menu level 2, the fan level and automatic mode can be set directly without taking into account the parameter "Fan level on switchover to manual", the switch-on level or fan run-on times (siehe Kapitel "Menu level" ▶ Page 18).

- i** The 1-bit object "Ventilation, auto/manual" only allows switchover between automatic and manual operation. It is not possible to switch the fan levels on using the object. This function is reserved solely for local control.
- i** Local actuation of sensor button T3.1 on the device deactivates manual operation and causes the controller to switch over to automatic operation.
- i** When changing from manual operation to automatic operation, the waiting time configured in the ETS is taken into account in the case of a connected level change.

- i** The parameter "Fan level on change-over to manual" is not checked for plausibility in the ETS, meaning that an incorrect configuration is possible. For this reason, care should be taken to ensure that there is no level in the configuration which is higher than the actual fan levels. If a level which does not exist is to be configured for the change-over to manual control, then the fan controller changes over to the maximum possible level when changing over to manual operation.
- i** In manual operation, the switch-on level only functions in certain situations (see next section "Switch-on level").

Switch-on level

The fan can, if it was switched off before and should now start up, be switched on at a defined switch-on level. This switch-on level can be any of the available fan levels, and is set in the ETS using the "Start-up via level" parameter. The switch-on level is generally one of the higher fan levels of a fan coil unit, so that at the beginning of a heating or cooling process the fan can start up correctly (reliable start-up of the fan motor through transfer of a higher torque, and thus a higher fan speed). The switch-on level remains active for the "Waiting time on level change-over" configured in the ETS. In automatic operation, the controller only switches to the fan level specified by the command value, when the waiting time has elapsed. There is no change-over if, after the waiting time has elapsed, the fan level specified by the command value equals the switch-on level.

- i** If the controlled fan requires a longer period of time for the start-up, then the waiting time in the ETS should be configured to higher values (possible time range 100 ms ... 25.5 s). It should be noted that the waiting time is also taken into account on each level change-over in automatic operation!
- i** The switch-on level is always taken into account by the fan controller in automatic mode on switching the fan on (if it was previously switched off by the command value evaluation).
- i** The fan controller also switches on via the switch-on level when the "Fan controller ..." parameters on the "RTC - fan controller" parameter page were configured to a fixed fan level. In so doing, the "Waiting time on level switchover" is taken into account.
- i** A configured switch-on level is applied directly without a waiting time.
- i** With a fan switchover via the 1-bit objects, when the fan level is changed by the controller, the active fan level is first switched off before the new level is switched on. In this case, the switch-off of a fan level and the subsequent switchover to a new fan level are not evaluated as a fan start-up, also meaning that the switch-on level is not set. In automatic operation, the switch-on level is only taken into account if the fan was switched off previously by the command value evaluation (command value < level 1 threshold value minus hysteresis) and then it is to start up using a new command value.

- i** The start-up via the switch-on level also takes place after a switchover from manual operation to automatic operation, providing that the fan was most recently switched off in manual operation and, in automatic operation, a new command value requires the fan to be switched on.
- i** The parameter "Start-up via level" is not checked for plausibility in the ETS, meaning that an incorrect configuration is possible. For this reason, care should be taken to ensure that there is no switch-on level in the configuration which is higher than the actual fan levels. The fan controller automatically corrects a faulty parameterisation by activating level 1 for the start-up, meaning that the fan starts up normally without a switch-on level.

Fan level limit

To reduce the fan noise of a fan coil, the fan level limit can be activated. The level limit reduces the sound emissions by limiting the maximum fan level to a fan level value specified in the ETS by the "Level limit" parameter (limit level). The limitation can be switched on and off via a 1-bit "Fan, level limit" object, and thus activated in accordance with requirements, for example via a timer during night-time hours in order to reduce noise in bedrooms, or via "manual" operation of a pushbutton when a "quiet room" is needed (auditorium or the like). The limitation of the fan level is activated by receipt of a "1" telegram via the object "Fan, level limitation". Deactivation is therefore achieved through the receipt of a "0" telegram.

While a limitation is active, the fan controller prevents the fan from being switched to a higher level than the limitation level. If, at the instant that the limit is activated, the fan is running at a level that is greater than the limit level, then the fan level is immediately reduced to the limitation value. In this case, the switching sequence of the individual levels and the waiting time configured in the ETS are also taken into account in the level switchover.

The limitation level can be one of the available fan levels.

The level controller distinguishes between Automatic and Manual operation.

- i** The fan level limit overdrives the switch-on level. As a result, when the fan is switched on, if the limit is active, the level has an active limit and the switch-on limit is not started. In this case, the limit level is jumped to without waiting.
- i** The level limit has no effect with an activated fan forced position.
- i** The parameter "Level limit" is not checked for plausibility, meaning that an incorrect configuration is possible. For this reason, care should be taken to ensure that there is no limit level in the configuration which is higher than the actual fan levels. If a higher limit level is configured, then the limit has no effect.

Forced fan position

The controller provides the option of activating a forced fan position via the bus. With an active forced position, the fan levels can neither be controlled nor switched over in either automatic or manual mode. The fan remains in the forced state until the forced position is removed using the bus. In this manner, it is possible to switch the fan to a locked and controlled state, for example for servicing purposes.

As soon as a "1" telegram is received via the

1-bit object "Ventilation, forced position", the controller immediately sets the fan level configured in the ETS without delay. The fan can also be completely switched off. The only special feature when activating the forced position is the fact that the fan controller is in automatic operation and a waiting time elapses, due to a previous level change-over. In this case, the fan controller only switches to the forced position level without the waiting time elapsing.

The forced position is dominant. For this reason, it can be overdriven from automatic mode, manual mode, the level limit or fan protection. Only when the forced position is removed does the fan control begin to control the fan levels according to the active operating mode.

The removal takes place when a "0" telegram is received via the object "Ventilation, forced position". The fan always switches itself off first. In automatic operation, the controller then evaluates the active command value and, when the waiting time configured in the ETS has elapsed, switches to the required fan level, taking an optionally-configured switch-on level into account. In manual operation, the fan first remains switched off. The fan level is only raised when the manual control button is pressed again. If a switch-on level is configured, the controller will, when a button is pressed, switch to the switch-on level and remain there until further operation occurs.

- i** The parameter "Behaviour in a forced position" is not checked for plausibility, meaning that an incorrect configuration is possible. For this reason, care should be taken to ensure that there is no fan level in the configuration which is higher than the actual fan levels. If a higher level is configured for behaviour in a forced position than the number of fan levels, then the fan controller will start up the maximum possible level when the forced position is activated.
- i** The forced fan position does not influence the control algorithm integrated in the controller. The command values of the PI feedback control continue to be transmitted to the bus, even with a forced fan.

Command value limiting values and command value offset

In automatic operation, the command value of the controller is used internally in the device to control the fan levels, according to the fan operating mode. As a transition between the levels, there are threshold values, defined according to the command value of the controller, which can be set using parameters in the ETS. The evaluation of the controller command values can be specially influenced for automatic fan control.

The command value to be evaluated for the fan controller can be influenced by the "Command value is 0% until internal command value is greater than" parameter in the lower command value range. The fan controller only evaluates the command value according to the configured threshold values when the internal command value of the controller exceeds the configured limiting value. With smaller command values, the fan remains at a standstill.

Similarly, the command value to be evaluated for the fan controller can be limited by the "Command value is 100% as soon as internal command value is greater than" parameter in the upper command value range. In this case, the controller evaluates command values which exceed the configured limiting value as 100%. This means that the fan works at full power even with command values not at the maximum.

The "Command value offset" parameter allows configuration of a constant command value offset for the fan. The fan controller always adds the configured offset to the command value to be evaluated. The effect of this is that the fan turns at greater power than required by the command value, according to the threshold values. The result of this is that, even if the command value is switched off, the fan will continue to work when the first command value threshold value is exceeded by the offset.

- i** A configured command value offset cannot not affect a command value of greater than 100%. The maximum command value of the fan controller is therefore defined as 100 %.

Fan protection

The fan protection function allows the fan of a fan coil unit, which has not been active for some time, to be temporarily switched to the maximum level. In this way, the controller fan motors can be protected against stiffness. In addition, the fan blades and the heat exchanger of the fan coil unit are protected against dust against dust. If the fan protection is to be used, it must be enabled using the parameter of the same name in the ETS. Fan protection can then be activated or deactivated directly using the 1-bit communication object "Ventilation, fan protection", for example using a KNX/EIB time switch.

If the fan protection object has the switching value "1", then the fan protection function is active. The fan then works at the highest possible fan level and overdrives automatic and manual operation. Fan protection can then be switched off again using the "0" switching value in the communication object.

The reaction of the fan to switching fan protection depends on the operating mode of the automatic fan system. In automatic operation, the fan switches back to the level determined by the command value of the room temperature control. In manual operation, the fan switches off and can then be switched on again by additional manual actuation. The "Start-up via level" parameter is taken into account here.

- i** Even if the fan controller is inactive due to the controller operating mode, it is possible to activate the fan using fan protection.
- i** With an active level limit, the maximum fan level of fan protection is specified by the limit level.
- i** For reasons of safety, fan protection is not carried out with an active forced position.
- i** If fan run-on times are configured in the ETS, then the fan is switched off after a delay when fan protection is deactivated.

10.9 Disabling functions

Disable controller

Certain operation conditions may require the deactivation of the room temperature control. For example, the controller can be switched-off during the dew point mode of a cooling system or during maintenance work on the heating or cooling system. The parameter "Switch off controller (dew point operation)" in the parameter node "Room temperature control -> RTC - General -> RTC - Controller functionality" enables the 1-bit object "Disable controller" when set to "Via bus". In addition, the controller disable function can be switched off when set to "No".

In case a "1" telegram is received via the enabled disable object, the room temperature control will be completely deactivated. In this case, all the command values are equal to "0"/"OFF" (wait 30 s for update interval of the command values). The controller, however, can be operated in this case via the communication objects.

10.10 Parameter group "Room temperature control (RTC)"

Room temperature control (RTC) -> RTC - General

Name of the controller	20-character free text
The text entered in this parameter is used to label the controller in the ETS parameter window and in the ETS object table (e.g. "Kitchen control", "Bathroom temperature"). The text is not programmed in the device.	
Operating mode	Heating Cooling Heating and cooling
The room temperature controller distinguishes between two different operating modes. The operating modes specify whether you want the controller to use its variable to trigger heating systems ("heating" single operating mode) or cooling systems ("cooling" single operating mode). You can also activate mixed operation, with the controller being capable of changing over between "Heating" and "Cooling" either automatically or, alternatively, controlled by a communication object.	
Transmit heating and cooling command values to one common object	yes no
If the parameter is set to "Yes", the command value will be transmitted on a shared object during heating or cooling. This function is used, if the same heating system is used to cool the room in the summer and used to heat the room in the winter. This parameter is only visible with "Heating and cooling" mixed operating mode.	
Type of heating control	continuous PI control Switching PI control (PWM)
This parameter selects the control algorithm for the heating system.	

Type of heating	Fan coil unit (4 K / 90 min) Split unit (4 K / 90 min) via control parameter
<p>Adapting the PI algorithm to different heating systems using predefined values for the proportional range and reset time control parameters.</p> <p>With the "Using control parameters" setting, it is possible to set the control parameters in a manner deviating from the predefined values within specific limits.</p> <p>This parameter is only visible if "Type of heating control = Continuous PI control".</p>	
Proportional range heating (10 ... 127 x 0.1 K)	10... 50 ...127
<p>Separate setting of the "Proportional range" control parameter.</p> <p>This parameter is only visible if "Type of heating = via control parameter" and the heating control type "PI control".</p>	
Reset time heating, minutes (0 ... 255)	0... 150 ...255
<p>Separate setting of the "Reset time" control parameter. The setting "0" deactivates the reset time.</p> <p>This parameter is only visible if "Type of heating = via control parameter" and the heating control type "PI control".</p>	
Type of cooling control	Continuous PI control Switching PI control (PWM)
<p>This parameter selects the control algorithm for the cooling system.</p>	
Type of cooling	Fan coil unit (4 K / 90 min) Split unit (4 K / 90 min) via control parameter
<p>Adapting the PI algorithm to different cooling systems using predefined values for the proportional range and reset time control parameters.</p> <p>With the "Using control parameters" setting, it is possible to set the control parameters in a manner deviating from the predefined values within specific limits.</p> <p>This parameter is only visible if "Type of cooling control = PI control".</p>	
Proportional range cooling (10 ... 127 x 0.1 K)	10... 50 ...127
<p>Separate setting of the "Proportional range" control parameter.</p> <p>This parameter is only visible if "Type of cooling = via control parameter" and the cooling control type "PI control".</p>	
Reset time cooling, minutes (0 ... 255)	0... 150 ...255
<p>Separate setting of the "Reset time" control parameter. The setting "0" deactivates the reset time.</p> <p>This parameter is only visible if "Type of cooling = via control parameter" and the cooling control type "PI control".</p>	

Operation mode after reset	Restore operating mode before reset Comfort mode Standby mode Night operation Frost/heat protection mode
<p>This parameter specifies which operating mode is set immediately after a device re-set.</p> <p>This parameter is only visible when the controller mode is configured as "KNX".</p> <p>This parameter is permanently set to "Comfort operation", if the controller mode is configured as "KNX" and the parameter "Presence permanently active" is configured to "Yes".</p>	
Profile after reset	Restore profile before reset Comfort Comfort- Eco Standby
<p>This parameter specifies which profile is set immediately after a device reset. This parameter is only visible when the controller mode is configured as "Hotel".</p>	
Change-over between heating and cooling	automatic via object (heating/cooling change-over)
<p>In a configured mixed mode it is possible to switch over between heating and cooling.</p> <p>With "Automatic": Depending on the operating mode ("KNX" controller mode) or the profile ("Hotel" controller mode) and the room temperature, the switchover takes place automatically.</p> <p>With "via object (heating/cooling change-over)": The change-over takes place only via the object "Heating/cooling change-over".</p>	
Cyclical heating/cooling transmission switchover minutes (0 = inactive) (0...255)	0 ... 255
<p>This parameter specifies whether the current object status of the "Heating / cooling change-over" object should be output cyclically to the bus on an automatic change-over. The cycle time can be set here. The "0" setting deactivates the periodic transmission of the object value.</p> <p>Only visible if "Change-over between heating and cooling = automatic".</p>	
Heating / cooling mode after a reset	Heating Cooling Operating mode before reset
<p>The preset operating mode for after a bus voltage return or an ETS programming operation is specified here.</p> <p>Only visible if "Switchover between heating and cooling = via object"!</p>	

Frost/heat protection	Automatic frost protection via window status
<p>In addition to the operating mode switchover by the corresponding operating mode switchover object or by room temperature regulator operation on the device, Frost/heat protection mode can be activated by a window contact or, alternatively, frost protection can be activated by an automatic temperature control option. This parameter defines the manner in which the higher-priority switchover takes place, compared to the operating mode switchover by an object or button function. This parameter is only visible when the controller mode is configured as "KNX".</p>	
Window status delay (minutes, 0 = inactive)	0 ... 255
<p>You can optionally configure a window status delay. This delay can make sense if short ventilation of the room by opening the window is not supposed to cause an operating mode switchover. You can use the "window status delay" parameter to set this delay time between 1 and 255 minutes. The window status will only be changed and thus the frost/heat protection mode activated after this parameterized time has elapsed. A setting of "0" will effect the immediate activation of the frost/heat protection mode when the window is open. The window status will be in effect in the heating and in the cooling mode. This parameter is only visible if the parameter "Frost/heat protection" is set to "Via window status".</p>	
Automatic frost protection temperature drop	Off 0.2 K / min 0.3 K / min 0.4 K / min 0.5 K / min 0.6 K / min
<p>You can use the "automatic frost protection temperature drop" parameter to set the maximum temperature drop in K/min for switching over to the frost protection mode. After the time preset by the "frost protection period in automatic mode" parameter has elapsed, the regulator will return into the mode which was set before frost protection. Re-triggering will not be possible.</p>	
Frost protection period, automatic mode (minutes)	1 ... 20 ... 255
<p>This parameter defines the length of the frost protection when frost protection is activated automatically.</p>	
"Building Protection" profile additionally via	automatic "Building Protection" Window status
<p>In addition to the profile switchover by the corresponding profile switchover object or by room temperature regulator operation on the device, Building Protection can be activated by a window contact or, alternatively, by an automatic "Building Protection" option. This parameter defines the manner in which the higher-priority switchover takes place, compared to the profile switchover by an object or button function. This parameter is only visible when the controller mode is configured as "Hotel".</p>	

Window status delay (minutes, 0 = inactive)	0 ... 255
<p>You can optionally configure a window status delay. This delay can make sense if short ventilation of the room by opening the window is not supposed to cause an operating mode switchover. You can use the "window status delay" parameter to set this delay time between 1 and 255 minutes. The window status will only be changed and thus the frost/heat protection mode activated after this parameterized time has elapsed. A setting of "0" will effect the immediate activation of the frost/heat protection mode when the window is open. The window status will be in effect in the heating and in the cooling mode. This parameter is only visible if the parameter "Frost/heat protection" is set to "Via window status".</p>	
Automatic "Building Protection" temperature reduction	Off 0.2 K / min 0.3 K / min 0.4 K / min 0.5 K / min 0.6 K / min
<p>You can use the "Automatic "Building Protection" temperature reduction" parameter to set the maximum temperature drop in K/min for switching over to Building Protection. After the time preset by the ""Building Protection" period in automatic mode" parameter has elapsed, the controller will return to the previously set profile. Re-triggering will not be possible.</p>	
"Building Protection " period in automatic mode (minutes)	1 ... 20 ... 255
<p>This parameter defines the length of the Building Protection when Building Protection is activated automatically.</p>	
Delay for temperature-dependent profile switchover (minutes)	1 ... 30 ... 255
<p>The temperature-dependent profile switchover monitors the room temperature. Should the room temperature be too low in Heating mode or too high in Cooling mode, then the system switches from the current profile to the "Building Protection" profile. If necessary, a profile switchover delay can be configured. Only when the room temperature is too low or too high is the "Building Protection" profile activated. A setting of "0" will effect the immediate activation of the "Building Protection" profile if the room temperature is too low or too high.</p>	
Rotation angle conversion	Enabled Disabled
<p>This parameter enables further parameters and the communication object for the rotation angle conversion.</p> <p>This parameter is only available with the application program from version 1.2.</p>	

Voltage for command value for heating 100% (rotation angle) (x 0.1 V)	0 ... 5 ... 255
<p>The parameter determines the voltage value at which the rotary valve sets the angle for maximum heating. It must be taken from the valve's documentation.</p> <p>This parameter is only visible if the parameter "Rotation angle conversion" is set to "enabled".</p>	
Voltage for command value for heating 0% (rotation angle) (x 0.1 V)	0 ... 45 ... 255
<p>The parameter determines the voltage value at which the rotary valve sets the angle for minimum heating. It must be taken from the valve's documentation.</p> <p>This parameter is only visible if the parameter "Rotation angle conversion" is set to "enabled".</p>	
Voltage for command value for cooling 0% (rotation angle) (x 0.1 V)	0 ... 55 ... 255
<p>The parameter determines the voltage value at which the rotary valve sets the angle for minimum cooling. It must be taken from the valve's documentation.</p> <p>This parameter is only visible if the parameter "Rotation angle conversion" is set to "enabled".</p>	
Voltage for command value for cooling 100% (rotation angle) (x 0.1 V)	0 ... 95 ... 255
<p>The parameter determines the voltage value at which the rotary valve sets the angle for maximum cooling. It must be taken from the valve's documentation.</p> <p>This parameter is only visible if the parameter "Rotation angle conversion" is set to "enabled".</p>	

RTC - Setpoint values

Overwrite setpoint in device during ETS programming operation?	yes no
<p>The setpoint temperatures programmed in the room temperature controller by the ETS during commissioning can be changed via communication objects. This parameter can be used to define whether the setpoints present in the device, which may have been changed subsequently, are overwritten during an ETS programming operation and thus replaced again by the values parameterised in the ETS. If this parameter is "Yes", then the setpoint temperatures are deleted in the device during a programming operation and replaced by the values of the ETS. If this parameter is configured to "No", then setpoints present in the device remain unchanged. The setpoint temperatures entered in the ETS then have no significance.</p>	

<p>Setpoint, heating comfort mode (basic setpoint temperature)</p>	<p>7.0 °C ... 22.0 ... 40.0 °C (Basic setting, temperature unit = °Celsius)</p> <p>7.0 °C ... 22.2 ... 40.0 °C (Basic setting, temperature unit = °Fahrenheit)</p>
<p>This parameter defines the temperature value to be applies as the basic setpoint for Comfort mode in the Heating operating mode after commissioning by the ETS. All the temperature setpoints are derived from the basic setpoint. This parameter is only visible if the "Operating mode" parameter is set to "Heating" or "Heating and cooling". The following applies in the "Heating and cooling" operating mode: "Setpoint, Comfort mode, cooling" = Setpoint, Comfort mode, heating" + "Deadband between heating and cooling".</p> <p>This parameter is only visible when the controller mode is configured as "KNX".</p>	
<p>Setpoint, Comfort mode, heating (basic setpoint temperature)</p>	<p>7.0 °C ... 22.0 ... 40.0 °C (Basic setting, temperature unit = °Celsius)</p> <p>7.0 °C ... 22.2 ... 40.0 °C (Basic setting, temperature unit = °Fahrenheit)</p>
<p>This parameter defines the temperature value to be applies as the basic setpoint for the "Comfort" profile in the Heating operating mode after commissioning by the ETS. All the temperature setpoints are derived from the basic setpoint. This parameter is only visible if the "Operating mode" parameter is set to "Heating" or "Heating and cooling". The following applies in the "Heating and cooling" operating mode: "Setpoint, Comfort, cooling" = Setpoint, Comfort, heating" + "Deadband between heating and cooling".</p> <p>This parameter is only visible when the controller mode is configured as "Hotel".</p>	
<p>Setpoint, cooling comfort mode (basic setpoint temperature)</p>	<p>7.0 °C ... 24.0 ... 40.0 °C (Basic setting, temperature unit = °Celsius)</p> <p>7.0 °C ... 24.4 ... 40.0 °C (Basic setting, temperature unit = °Fahrenheit)</p>
<p>This parameter defines the temperature value to be applies as the basic setpoint for Comfort mode in the Cooling operating mode after commissioning by the ETS. All the temperature setpoints are derived from the basic setpoint. This parameter is only visible if the "Operating mode" parameter is set to "Cooling".</p> <p>This parameter is only visible when the controller mode is configured as "KNX".</p>	

Setpoint, Comfort mode, cooling (basic setpoint temperature)	<p>7.0 °C ... 24.0 ... 40.0 °C (Basic setting, temperature unit = °Celsius)</p> <p>7.0 °C ... 24.4 ... 40.0 °C (Basic setting, temperature unit = °Fahrenheit)</p>
<p>This parameter defines the temperature value to be applies as the basic setpoint for the "Comfort" profile in the Cooling operating mode after commissioning by the ETS. All the temperature setpoints are derived from the basic setpoint. This parameter is only visible if the "Operating mode" parameter is set to "Cooling".</p> <p>This parameter is only visible when the controller mode is configured as "Hotel".</p>	
Permanently apply change to basic setpoint shift	<p>yes</p> <p>no</p>
<p>In addition to specifying individual setpoint temperatures by the ETS or basic setpoint object, the user can shift the basic setpoint in a specific range using the sensor buttons or a communication object. Whether a basic setpoint shifting only affects the currently active operating mode or whether it influences all other setpoint temperatures of the remaining operating modes is determined by this parameter.</p> <p>In the "yes" setting, the shift of the basic setpoint carried out affects all operating modes. The shift is maintained even after a switchover of the operating mode or the heating/cooling mode or adjusting the basic setpoint.</p> <p>In the "no" setting, the basic setpoint shift carried out is in effect for only as long as the operating mode or heating/cooling mode has not changed or the basic setpoint is maintained. Otherwise the setpoint shift will be reset to "0".</p> <p>This parameter is only visible when the controller mode is configured as "KNX".</p>	
Permanently apply change to basic setpoint shift for Comfort -> Eco profile change	<p>yes</p> <p>no</p>
<p>In addition to specifying individual setpoint temperatures by the ETS or basic setpoint object, the user can shift the basic setpoint in a specific range using the sensor buttons or a communication object. This parameter specifies whether a basis setpoint shift affects up to the "Eco" profile.</p> <p>In the "Yes" setting, the shifting of the basic setpoint carried out affects the "Comfort", "Comfort-" and "Eco" profiles. The shift is maintained even after a switchover of the profile or the operating mode or adjusting the basic setpoint.</p> <p>In the "No" setting, the basic setpoint shift carried out is in effect for the "Comfort" and "Comfort-" profiles for only as long as the operating mode has not changed or the basic setpoint is maintained. Otherwise the setpoint shift will be reset to "0".</p> <p>This parameter is only visible when the controller mode is configured as "Hotel".</p>	
Changing the setpoint of the basic temperature	<p>deactivated</p> <p>approve via bus</p>
<p>Here, it is possible to specify if it is possible to change the basic setpoint via the bus.</p>	

Permanently apply change to basic temperature setpoint?	yes no
<p>One has to distinguish between two cases, defined by this parameter, if the basic setpoint has been modified via the object.</p> <p>When "Yes": If, with this setting, the setpoint temperature is adjusted, the controller saves the value permanently to the permanent storage. The newly adjusted value will overwrite the initial value, i.e. the basic temperature originally configured via the ETS after a reset! The changed values are also retained after a device reset, after a switch-over of the operating mode or after a switch-over of the heating/cooling mode.</p> <p>When "no": The setpoints set on the room temperature controller or received via the objects remain active only temporarily. In case of a bus voltage failure, after a switchover to another operating mode (e.g. Comfort to Standby, or also Comfort to Comfort), or after a switchover of the operating mode (e.g. Heating to Cooling), the last setpoint changed will be discarded and replaced by the initial value.</p> <p>This parameter is only visible when the controller mode is configured as "KNX".</p>	

Permanently apply change to basic temperature setpoint on profile change? Reset through "Standby" profile.	yes no
<p>One has to distinguish between two cases, defined by this parameter, if the basic setpoint has been modified via the object.</p> <p>When "Yes": If, with this setting, the setpoint temperature is adjusted, the controller saves the value permanently to the permanent storage. The newly adjusted value will overwrite the initial value, i.e. the basic temperature originally configured via the ETS after a reset! The changed values are also retained after a device reset, after a switchover of the profile or after a switchover of the operating mode. A switchover to the "Standby" rejects the most recently changed setpoint and replaces it with the initial value.</p> <p>When "no": The setpoints set on the room temperature controller or received via the objects remain active only temporarily. In case of a bus voltage failure, after a switchover to another profile (e.g. Comfort to Standby, or also Comfort to Comfort), or after a switchover of the operating mode (e.g. Heating to Cooling), the last setpoint changed will be discarded and replaced by the initial value.</p> <p>This parameter is only visible when the controller mode is configured as "Hotel".</p>	

<p>Deadband between heating and cooling (0...127) x 0.1 K</p>	<p>0...20...127 (Basic setting, temperature unit = °Celsius)</p> <p>0...22...127 (Basic setting, temperature unit = °Fahrenheit)</p>
<p>With relative setpoint presetting, the comfort setpoint temperatures for heating and cooling are derived from the basic setpoint in consideration of the adjusted Dead band. The deadband (temperature zone for which there is neither heating nor cooling) is the difference between the comfort setpoint temperatures. It is set using this parameter. The parameter is only visible in the "Heating and cooling" operating mode.</p>	
<p>Type of setpoint shift</p>	<p>Via levels (DPT 6.010) Via offset (DPT 9.002)</p>
<p>Depending on the setting of the parameter "Type of setpoint shift", the shift takes place via the 2-byte communication object "Setpoint shift specification" (acc. to KNX DPT 9.002) or via the 1-byte-communication object "Setpoint shift specification" (acc. to KNX DPT 6.010). This parameter is only visible with relative setpoint presetting!</p>	
<p>Value of the setpoint shift</p>	<p>0.5 K 1.0 K 1.5 K 2.0 K</p>
<p>This parameter defines the value of a level of the setpoint shift. With a setpoint shift, the basic setpoint is changed by the temperature value configured here when there is an adjustment by one step in a positive or negative direction. The controller module rounds the temperature values received via the "Basic Setpoint" object and matches the values to the step width configured here. This parameter is only visible when the basic setting of the temperature unit is set to "°Celsius".</p>	
<p>Value of the setpoint shift</p>	<p>1 °F 2 °F 3 °F 4 °F</p>
<p>This parameter defines the value of a level of the setpoint shift. With a setpoint shift, the basic setpoint is changed by the temperature value configured here when there is an adjustment by one step in a positive or negative direction. The controller module rounds the temperature values received via the "Basic Setpoint" object and matches the values to the step width configured here. This parameter is only visible when the basic setting of the temperature unit is set to "°Fahrenheit".</p>	

<p>Lower the setpoint temp. during standby operation (heating) (-100...0 x 0,1 K)</p>	<p>-100...-20...0 (Basic setting, temperature unit = °Celsius) -100...-22...0 (Basic setting, temperature unit = °Fahrenheit)</p>
<p>The value by which the standby setpoint temperature for heating is lowered compared to the heating comfort temperature. The parameter is only visible in "Heating" or "Heating and cooling" operating modes and in the "KNX" controller mode.</p>	
<p>Reducing of the setpoint temperature in the Comfort- profile, heating (K) (-100...0 x 0.1 K)</p>	<p>-100...-20...0 (Basic setting, temperature unit = °Celsius) -100...-22...0 (Basic setting, temperature unit = °Fahrenheit)</p>
<p>The value by which the "Comfort-" setpoint temperature for heating is lowered compared to the "Comfort" heating temperature. The parameter is only visible in "Heating" or "Heating and cooling" operating modes and in the "Hotel" controller mode.</p>	
<p>Lower the setpoint temperature during Night mode, Heating (-100...0 x 0.1 K)</p>	<p>-100...-40...0 (Basic setting, temperature unit = °Celsius) -100...-24...0 (Basic setting, temperature unit = °Fahrenheit)</p>
<p>The value by which the night setpoint temperature for heating is lowered compared to the heating comfort temperature. The parameter is only visible in "Heating" or "Heating and cooling" operating modes and in the "KNX" controller mode.</p>	
<p>Reducing of the setpoint temperature in the Eco profile, heating (K) (-100...0 x 0.1 K)</p>	<p>-100...-40...0 (Basic setting, temperature unit = °Celsius) -100...-24...0 (Basic setting, temperature unit = °Fahrenheit)</p>
<p>The value by which the "Eco" temperature for heating is lowered compared to the "Comfort" heating temperature. The parameter is only visible in "Heating" or "Heating and cooling" operating modes and in the "Hotel" controller mode.</p>	

<p>Reducing of the setpoint temperature in the Standby profile, heating (K) (-100...0 x 0.1 K)</p>	<p>-100...-60...0 (Basic setting, temperature unit = °Celsius) -100...-67...0 (Basic setting, temperature unit = °Fahrenheit)</p>
<p>The value by which the "Standby" temperature for heating is lowered compared to the "Comfort" heating temperature. The parameter is only visible in "Heating" or "Heating and cooling" operating modes and in the "Hotel" controller mode.</p>	
<p>Raise the setpoint temp. during standby operation, cooling (0...100 x 0.1 K)</p>	<p>0...20...100 (Basic setting, temperature unit = °Celsius) 0...22...100 (Basic setting, temperature unit = °Fahrenheit)</p>
<p>The value by which the standby setpoint temperature for cooling is lowered compared to the cooling comfort temperature. The parameter is only visible in "Cooling" or "Heating and cooling" operating modes and in the "KNX" controller mode.</p>	
<p>Increasing the setpoint temperature in the Comfort- profile, cooling (K) (0...100 x 0.1 K)</p>	<p>0...20...100 (Basic setting, temperature unit = °Celsius) 0...22...100 (Basic setting, temperature unit = °Fahrenheit)</p>
<p>The value by which the "Comfort-" setpoint temperature for cooling is raised compared to the "Comfort" cooling temperature. The parameter is only visible in "Cooling" or "Heating and cooling" operating modes and in the "Hotel" controller mode.</p>	
<p>Raise the setpoint temperature during night operation, cooling (0...100 x 0.1 K)</p>	<p>0...40...100 (Basic setting, temperature unit = °Celsius) 0...45...100 (Basic setting, temperature unit = °Fahrenheit)</p>
<p>The value by which the night temperature for cooling is lowered compared to the cooling comfort temperature. The parameter is only visible in "Cooling" or "Heating and cooling" operating modes and in the "KNX" controller mode.</p>	

<p>Increasing the setpoint temperature in the Eco profile, cooling (K) (0...100 x 0.1 K)</p>	<p>0...40...100 (Basic setting, temperature unit = °Celsius) 0...45...100 (Basic setting, temperature unit = °Fahrenheit)</p>
<p>The value by which the "Eco" temperature for cooling is raised compared to the "Comfort" cooling temperature. The parameter is only visible in "Cooling" or "Heating and cooling" operating modes and in the "Hotel" controller mode.</p>	
<p>Increasing the setpoint temperature in the Standby profile, cooling (K) (0...100 x 0.1 K)</p>	<p>0...60...100 (Basic setting, temperature unit = °Celsius) 0...67...100 (Basic setting, temperature unit = °Fahrenheit)</p>
<p>The value by which the "Standby" temperature for cooling is raised compared to the "Comfort" cooling temperature. The parameter is only visible in "Cooling" or "Heating and cooling" operating modes and in the "Hotel" controller mode.</p>	
<p>Transmission at setpoint temperature change by (0...255 x 0,1 K)</p>	<p>0...1...255</p>
<p>Determines the size of the value change required to automatically transmit the current value via the "Setpoint temperature" object. In the "0" setting, the setpoint temperature is not transmitted automatically when there is a change.</p>	
<p>Cyclical transmission of setpoint temperature, minutes (0 = inactive) (0...255)</p>	<p>0...255</p>
<p>This parameter determines whether the setpoint temperature is to be transmitted periodically via the "Setpoint temperature" object. Definition of the cycle time by this parameter In the "0" setting, the setpoint temperature is not transmitted automatically cyclically.</p>	

Setpoint temperature limit in cooling operation	<p>no limit</p> <p>Only difference to outdoor temperature</p> <p>Only max. setpoint temperature</p> <p>Max. setpoint and difference to outdoor temperature</p>
-------------------------------------------------	-----------------------------------------------------------------------------------------------------------------------------------------------------------------------

Optionally, the setpoint temperature limit can be enabled here, which is only effective in cooling operation. If necessary, the controller limits the setpoint temperature to specific values and prevents an adjustment beyond the limits.

"Only difference to outdoor temperature" setting, the outdoor temperature is monitored and compared to the active setpoint temperature in this setting. The specification of the maximum temperature difference to the outdoor temperature is made using the "Difference to outdoor temperature in cooling mode" parameter. If the outdoor temperature rises above 32 °C, then the controller activates the setpoint temperature limit. It then permanently monitors the outdoor temperature and raises the setpoint temperature so that is beneath the outdoor temperature by the amount configured. Should the outdoor temperature continue rise, the controller raises the setpoint temperature until the required difference to the outdoor temperature is achieved, or, at most, the heat protection temperature. It is then not possible to undershoot the raised setpoint, e.g. by changing the basic setpoint change. The change to the setpoint temperature limit is temporary. It only applies for as long as the outdoor temperature exceeds 32 °C.

"Only max. setpoint temperature" setting: In this setting, no setpoint temperatures are permitted in Cooling mode related to the Comfort, Standby and Night modes, which are greater than the maximum setpoints configured in the ETS. The maximum temperature setpoint is specified by the "Max. setpoint temperature in cooling operation" parameter. With an active limit, no larger setpoint can be set in cooling operation, e.g. by a basic setpoint change or a setpoint shift. However, heat protection is not influenced by the setpoint temperature limit.

"Max. setpoint temperature and difference to outdoor temperature" setting: This setting is a combination of the two above-mentioned settings. In the downward direction, the setpoint temperature is limited by the maximum outdoor temperature difference, whilst in the upward direction, the limit is made by the maximum setpoint. The maximum setpoint temperature has priority over the outdoor temperature difference. This means that the controller keeps on raising the setpoint temperature upwards according to the difference to the outdoor temperature configured in the ETS until the maximum setpoint temperature or the heat protection temperature is exceeded. Then the setpoint is limited to the maximum value.

Activation of the setpoint temperature limit in cooling operation via object?	<p>no</p> <p>yes</p>
-------------------------------------------------------------------------------	------------------------------------

A setpoint limit enabled in the ETS can be activated or deactivated as necessary using a 1-bit object. For this, this parameter can be set to "Yes". In this case, the controller only takes the setpoint limit into account, if it has been enabled via the object "Cooling setpoint temperature limit" ("1" telegram). If the limitation is not enabled ("0" telegram), the cooling setpoint temperatures are not limited.

This parameter is visible only if setpoint temperature monitoring is enabled.

Difference to outdoor temperature in cooling operation (1...15 K)	1 K... 6 K ...15 K
<p>This parameter defines the maximum difference between the setpoint temperature in Comfort mode and the outdoor temperature with an active setpoint temperature limit. This parameter is visible only if setpoint temperature monitoring is enabled. However, this is only if the parameter "Setpoint temperature limit in cooling operation" is then set to "Only difference to outdoor temperature" or "Max. setpoint temperature and difference to outdoor temperature".</p>	

Maximum setpoint temperature in cooling operation	20°C... 26°C ...35°C
<p>This parameter defines the maximum setpoint temperature in Comfort mode with an active setpoint temperature limit. This parameter is visible only if setpoint temperature monitoring is enabled. However, this is only if the parameter "Setpoint temperature limit in cooling operation" is then set to "Only max. setpoint temperature" or "Max. setpoint temperature and difference to outdoor temperature".</p>	

Room temperature control "RTC - Command value and status output"

Automatic transmission on change by (0 = inactive) (0...100 %)	0... 3 ...100
<p>This parameter determines the size of the command value change that will automatically transmit continuous command value telegrams via the command value objects. Thus this parameter only affects command values which are configured to "Continuous PI control" and to the 1 byte additional command value objects of the "Switching PI control (PWM)".</p>	

Cycle time of the switching command value minutes (1...255)	1... 15 ...255
<p>This parameter specifies the cycle time for the pulse width modulated command value (PWM). Thus this parameter only affects command values which are configured to "Switching PI control (PWM)".</p>	

Cycle time for automatic transmission (0 = inactive) (0...255)	0... 10 ...255
<p>This parameter determines the time interval for the cyclical transmission of the command values via all command value objects.</p>	

Output of the heating variable	<p>normal (under current, this means opened)</p> <p>inverted (under current, this means closed)</p>
<p>At this point, it is possible to specify whether the command value telegram for heating is output normally or in inverted form. This parameter is only visible if the operating mode "Heating" or "Heating and cooling" is configured.</p>	

Output of the cooling variable	normal (under current, this means opened) inverted (under current, this means closed)
<p>At this point, it is possible to specify whether the command value telegram for cooling is output normally or in inverted form.</p> <p>This parameter is only visible if the operating mode "Cooling" or "Heating and cooling" is configured.</p>	
Heating indication	yes no
<p>Depending on the set operating mode, a separate object can be used to signal whether the controller is currently demanding heating energy and is thus actively heating. The "Yes" setting here enables the message function for heating.</p>	
Cooling indication	yes no
<p>Depending on the set operating mode, a separate object can be used to signal whether the controller is currently demanding cooling energy and is thus actively cooling. The "Yes" setting here enables the message function for cooling.</p>	
Command value limit	deactivated continuously activated can be activated via object
<p>The command value limit allows the restriction of calculated command values to the range limits "minimum" and "maximum". The limits are permanently set in the ETS and, if command value limitation is active, can be neither undershot or exceeded during device operation.</p> <p>The "Command value limit" parameter defines the mode of action of the limiting function. The command value limit can either be activated or deactivated using the 1-bit communication object "Command value limit", or be permanently active.</p>	
Command value limit after reset	deactivated activated
<p>When controlling via the object, it is possible to have the controller activate the command value limit automatically after bus voltage return or an ETS programming operation. This parameter defines the initialisation behaviour here.</p> <p>In the "Deactivated" setting, the command value limit is not automatically activated after a device reset. A "1" telegram must first be received via the "Command value limit" object for the limit to be activated.</p> <p>In the "Activated" setting, the controller activates the command value limit automatically after a device reset. To deactivate the limit a "0" telegram must be received via the "Command value limit" object. The limit can be switched on or off at any time using the object.</p> <p>This parameter is only visible with "Command value limit = can be activated via object"!</p>	

Minimum command value for heating	5%, 10% , 15%, 20%, 25%, 30%, 35%, 40%, 45%, 50%
-----------------------------------	---------------------------------------------------------

The "Minimum command value" parameter specifies the lower command value limiting value for heating. With an active command value limit, the set minimum command value is not undershot by command values. If the controller calculates smaller command values, it sets the configured minimum command value. The controller transmits a 0% command value if no more heating or cooling energy has to be demanded.

Maximum command value for heating	55%, 60%, 65%, 70%, 75%, 80%, 85%, 90%, 95% , 100%
-----------------------------------	-----------------------------------------------------------

The "Maximum command value" parameter specifies the upper command value limiting value for heating. With an active command value limit, the set maximum command value is not exceeded. If the controller calculates larger command values, it sets the configured maximum command value.

Minimum command value for cooling	5% , 10%, 15%, 20%, 25%, 30%, 35%, 40%, 45%, 50%
-----------------------------------	---------------------------------------------------------

The "Minimum command value" parameter specifies the lower command value limiting value for cooling. With an active command value limit, the set minimum command value is not undershot by command values. If the controller calculates smaller command values, it sets the configured minimum command value. The controller transmits a 0% command value if no more heating or cooling energy has to be demanded.

Maximum command value for cooling	55%, 60%, 65%, 70%, 75%, 80%, 85%, 90%, 95% , 100%
-----------------------------------	-----------------------------------------------------------

The "Maximum command value" parameter specifies the upper command value limiting value for cooling. With an active command value limit, the set maximum command value is not exceeded. If the controller calculates larger command values, it sets the configured maximum command value.

Controller status	no status KNX compliant Controller general
-------------------	---------------------------------------------------------

The room temperature controller can transmit its current status to the KNX. A choice of data formats is available for this. This parameter enables the status signal and sets the status format.

Room temperature control (RTC) - RTC - Controller functionality

Switch off controller (dew point operation)	no via bus
---------------------------------------------	----------------------

This parameter enables the "Disable controller" object. If the controller is disabled, there is no feedback control until enabled (command values = 0).

Room temperature control (RTC) - RTC - Fan control

Number of fan levels	1 fan level 2 fan levels 3 fan levels
The fan controller of the room temperature controller supports up to 3 fan level outputs, for which the actually used number of levels (1...3) is set using this parameter.	
Fan level switchover via	Switching objects (3 x 1 Bit) Value object (1 byte)
Depending on the data format of the objects of the controlled actuators, the switchover between the fan levels can either take place via up to 3 separate 1-bit objects or, alternatively, via one 1-byte object. The "Fan level change-over via" parameter defines the data format of the controller. With the 1-bit objects, each fan level discreetly receives its own object. With the 1-byte object, the active fan level is expressed by a value ("0" = Fan OFF / "1" = Level 1 / "2" = Level 2 / "3" = Level 3).	
Fan OFF threshold value -> Level 1 (1...100 %)	0... 1 ...100
In automatic operation, the command value of the controller is used internally in the device for automatic control of the fan levels. As a transition between the levels, there are threshold values, defined according to the command value of the controller, which can be set here. If the command value reaches the threshold value of a level during an increase of the command value, the appropriate level is activated. If the command value reaches below a threshold value, minus the configured hysteresis, during a reduction of the command value, then the switchover takes place into the next lowest fan level.	
Fan level 1 threshold value -> Level 2 (1...100 %)	0... 30 ...100
Fan level 2 threshold value -> Level 3 (1...100 %)	0... 60 ...100
Hysteresis between threshold values (1...50 %)	1... 3 ...50
If the command value of the room temperature control has undershot the threshold value minus the hysteresis, the fan controller switches back to the previous level.	
Waiting time for level switchover (seconds)	1... 2 ...255
Due to fan motors' inertia, as a rule there is a limit to how short the time intervals for switching the fan levels can be, i.e. there is a limit to how quickly the fan speed can be varied. If the fan controller is working in automatic mode, the settable "Waiting time on level change-over" is maintained on change-over of the levels. The timer starts the waiting time as soon as a threshold value is exceeded or not reached. The device only switches the fan level automatically when the waiting time has elapsed.	

Level limit (max. fan level)	No level limit Fan level 1 Fan level 2
<p>To reduce the fan noise of a fan coil, the fan level limit can be activated. The level limit reduces the sound emissions by limiting the maximum fan level to a fan level value configured here (limitation level). The limit can be switched on and off using the "Ventilation, level limit" 1-bit object and thus activated as necessary.</p> <p>The parameter "Level limit" is not checked for plausibility, meaning that an incorrect configuration is possible. For this reason, care should be taken to ensure that there is no limit level in the configuration which is higher than the actual fan levels. If a higher limit level is configured, then the limit has no effect.</p>	
Behaviour on forced position	no forced position Fan level 1 Fan level 2 Fan level 3 Fan level OFF
<p>The controller provides the option of activating a forced fan position via the bus. With an active forced position, the fan levels can neither be controlled nor switched over in either automatic or manual mode. The fan remains in the forced state until the forced position is removed using the bus. In this manner, it is possible to switch the fan to a locked and controlled state, for example for servicing purposes.</p> <p>As soon as the forced position is activated, the controller jumps to the fan level configured in this parameter without any waiting time. The fan can also be completely switched off.</p>	
Object interpretation, automatic/manual fan control	0=Automatic mode, 1=Manual mode 1=Automatic mode, 0=Manual mode
<p>The parameter specifies the polarity of the object for the change-over between automatic and manual fan control. Automatic mode is always active after a device reset.</p>	
Heating fan run-on time, seconds	0...255
<p>If the fan is switched-off in automatic or manual operation, it runs on for the time configured at this point, provided that a factor of more than "0" is set. This parameter applies to the controller operating mode "Heating".</p>	
Cooling fan run-on time, seconds	0...255
<p>If the fan is switched-off in automatic or manual operation, it runs on for the time configured at this point, provided that a factor of more than "0" is set. This parameter applies to the controller operating mode "Cooling".</p>	

Fan protection	Yes No
<p>The fan protection function allows the fan of a fan coil unit, which has not been active for some time, to be temporarily switched to the maximum level. In this way, the controller fan motors can be protected against stiffness. In addition, the fan blades and the heat exchanger of the fan coil unit are protected against dust against dust. If the fan protection is to be used, it must be enabled using the "Yes" setting at this point.</p>	
Start-up using level	Fan level 1 Fan level 2 Fan level 3
<p>The fan can, if it was switched off before and should now start up, be switched on at a defined switch-on level. This switch-on level can be any of the available fan levels, and is set using this parameter. The switch-on level is usually one of the higher fan levels of a blower convector. The switch-on level remains active for the "Waiting time on level change-over" configured in the ETS.</p> <p>The parameter "Start-up via level" is not checked for plausibility in the ETS, meaning that an incorrect configuration is possible. For this reason, care should be taken to ensure that there is no switch-on level in the configuration which is higher than the actual fan levels. The fan controller automatically corrects a faulty parameterisation by activating level 1 for the start-up, meaning that the fan starts up normally without a switch-on level.</p>	
Command value is 0%, until internal command value is greater than, percent	1...100
<p>The command value evaluated by the fan controller in automatic operation can be optionally limited by this parameter in the bottom command value range.</p>	
Command value is 100%, as soon as internal command value is greater than, percent	1... 99 ...100
<p>The command value evaluated by the fan controller in Automatic mode can be optionally limited by this parameter in the top command value range.</p>	
Command value offset, percent	0... 100
<p>The command value evaluated by the fan controller in Automatic mode can be optionally raised by the static offset configured here. Should the calculation produce a value of over 100 %, then the command value is limited to the maximum value.</p>	

Save manual fan level on change Comfort mode -> Night mode	<p>Yes</p> <p>No</p>
<p>In the "Yes" setting, the device saves the manual fan control settings on changing from Comfort mode to Night mode and recalls these settings on changing from Night mode to Comfort mode. The saved settings remain permanently intact. In the "No" setting, the controller rejects the settings of the manual fan level when changing the operating mode to Night mode. This parameter is only visible when the controller mode is configured as "KNX".</p>	
Save manual fan level on change Comfort -> Eco	<p>Yes</p> <p>No</p>
<p>In the "Yes" setting, the device saves the settings of the manual fan controller when changing from the "Comfort" or "Comfort-" profile to the "Eco" profile. The saved settings are recalled on changing from the "Eco" or "Comfort-" profile to the "Comfort" profile. The saved settings are rejected if the controller is switched over to the "Standby" profile in the meantime. The saved settings are not rejected on switching over to the "Building Protection" profile. In the "No" setting, the controller rejects the settings of the manual fan level when changing to the "Eco" or "Standby" profiles. This parameter is only visible when the controller mode is configured as "Hotel".</p>	

<p>Fan control standby mode</p>	<p>Auto Minimum auto fan level 1 Minimum auto fan level 2 Fixed fan level OFF Fixed fan level 1 Fixed fan level 2 Fixed fan level 3</p> <p>Auto Minimum auto fan level 1 Minimum auto fan level 2 Fixed fan level OFF Fixed fan level 1 Fixed fan level 2 Fixed fan level 3</p>
<p>Auto Minimum auto fan level 1 Minimum auto fan level 2 Fixed fan level OFF Fixed fan level 1 Fixed fan level 2 Fixed fan level 3: This parameter configures fan control for Standby mode. Only visible when the controller mode is configured as "KNX".</p> <p>Auto: For this energy level, fan control works in Automatic mode.</p> <p>Minimum auto fan level 1: For this energy level, fan control works in Automatic mode. This setting defines that fan level 1 is the minimum settable fan level. In consequence, the device never switches the fan off in this energy level.</p> <p>Minimum auto fan level 2: For this energy level, fan control works in Automatic mode. This setting defines that fan level 2 is the minimum settable fan level. In consequence, the device never switches the fan to fan level 1 or off in this energy level.</p> <p>Fixed fan level OFF: For this energy level, fan control is permanently switched off.</p> <p>Fixed fan level 1: For this energy level, fan control is permanently set to fan level 1.</p> <p>Fixed fan level 2: For this energy level, fan control is permanently set to fan level 2.</p> <p>Fixed fan level 3: For this energy level, fan control is permanently set to fan level 3.</p>	
<p>Fan control, "Comfort-" profile</p>	<p>Auto Minimum auto fan level 1 Minimum auto fan level 2 Fixed fan level OFF Fixed fan level 1 Fixed fan level 2 Fixed fan level 3</p>
<p>This parameter configures fan control for the "Comfort-" profile. Setting is performed in the same manner as the setting of the parameter "Fan control, Standby mode". This parameter is only visible when the controller mode is configured as "Hotel".</p>	

Fan control, Night mode	Auto Minimum auto fan level 1 Minimum auto fan level 2 Fixed fan level OFF Fixed fan level 1 Fixed fan level 2 Fixed fan level 3
This parameter configures fan control for "Night" mode. Setting is performed in the same manner as the setting of the parameter "Fan control, Standby mode". This parameter is only visible when the controller mode is configured as "Hotel".	
Fan control, "Eco" profile	Auto Minimum auto fan level 1 Minimum auto fan level 2 Fixed fan level OFF Fixed fan level 1 Fixed fan level 2 Fixed fan level 3
This parameter configures fan control for the "Eco" profile. Setting is performed in the same manner as the setting of the parameter "Fan control, Standby mode". This parameter is only visible when the controller mode is configured as "Hotel".	
Fan control, "Standby" profile	Auto Minimum auto fan level 1 Minimum auto fan level 2 Fixed fan level OFF Fixed fan level 1 Fixed fan level 2 Fixed fan level 3
This parameter configures fan control for the "Standby" profile. Setting is performed in the same manner as the setting of the parameter "Fan control, Standby mode". This parameter is only visible when the controller mode is configured as "Hotel".	

10.11 Object table "room temperature controller"

Objects for setpoint temperature specification

Function: Setpoint temperature specification

Object no.	Function	Name	Type	DPT	Flag
50	Basic setpoint	Controller - Input	2 bytes	9,001	C, (R), W, -, -
2-byte object for external specification of the basic setpoint for <u>relative setpoint specification</u> . Depending on the operating mode, the possible range of values is limited by the configured frost protection and/or heat protection temperature. The controller rounds the temperature values received via the object depending on the configured interval of the basic setpoint shift (0.5 K, 1.0 K, 1.5 K, 2.0 K). The temperature value must always be specified in the format "°C".					

Objects for operating mode switchover (KNX controller mode) / Profile switchover (Hotel controller mode)

Function: Operating mode switchover

Object no.	Function	Name	Type	DPT	Flag
52	Operating mode switchover	Controller - Input	1 bytes	20,102	C, (R), W, T, -
<p>1-byte object for change-over of the operating mode of the controller according to the KNX specification. This object is only visible when the controller mode is configured as "KNX" and the parameter "Parameter permanently active" is configured to "No".</p> <p>After bus voltage return or an ETS programming operation (controller reset), the current operating mode is transmitted via this object.</p>					

Function: Profile switchover

Object no.	Function	Name	Type	DPT	Flag
52	Profile switchover	Controller - Input	1 bytes	20,102	C, (R), W, T, -
<p>1-byte object for switchover of the profile of the controller according to the KNX specification. This object is only visible when the controller mode is configured as "Hotel".</p> <p>After bus voltage return or an ETS programming operation (controller reset), the current profile is transmitted via this object.</p>					

Function: Operating mode switchover

Object no.	Function	Name	Type	DPT	Flag
56	Operating mode forced-control	Controller - Input	1 bytes	20,102	C, (R), W, T, -
<p>1-byte object for forced change-over (highest priority) of the operating mode of the controller according to the KNX specification. This object is only visible when the controller mode is configured as "KNX".</p>					

Function: Profile switchover

Object no.	Function	Name	Type	DPT	Flag
56	Forced object, profile switchover	Controller - Input	1 bytes	20,102	C, (R), W, T, -
<p>1-byte object for forced switchover (highest priority) of the profile of the controller according to the KNX specification. This object is only visible when the controller mode is configured as "Hotel".</p>					

Function: Profile switchover

Object no.	Function	Name	Type	DPT	Flag
83	Standby profile switchover	Controller - Input	1-bit	1,001	C, (R), W, -, -

1-bit object for switchover to the "Standby" profile. This object is only visible when the controller mode is configured as "Hotel".

Function: Profile switchover

Object no.	Function	Name	Type	DPT	Flag
84	Status, Standby profile	Controller - Output	1-bit	1,001	C, R, -, T, -

1-bit object as a status signal when the "Standby" profile is active. After bus voltage return or an ETS programming operation (controller reset), the "Standby" operating mode, if active, is transmitted via this object. This object is only visible when the controller mode is configured as "Hotel". This object is not visible when the parameter "Controller status" is set to "No status".

Function: Profile switchover

Object no.	Function	Name	Type	DPT	Flag
85	Profile switchover, standby forced	Controller - Input	1-bit	1,001	C, (R), W, -, -

1-bit object for forced switchover (highest priority) to the "Standby" profile. This object is only visible when the controller mode is configured as "Hotel".

Function: Profile switchover

Object no.	Function	Name	Type	DPT	Flag
86	Forced status, Standby profile	Controller - Output	1-bit	1,001	C, R, -, T, -

1-bit object as a status signal when the "Standby" profile is forcibly activated (highest priority). After bus voltage return or an ETS programming operation (controller reset), the "Standby" operating mode, if active, is transmitted via this object. This object is only visible when the controller mode is configured as "Hotel". This object is not visible when the parameter "Controller status" is set to "No status".

Function: Presence detection, operating mode switchover / profile switchover

Object no.	Function	Name	Type	DPT	Flag
57	Presence detector	Controller - Input	1-bit	1,001	C, (R), W, T, -

1-bit object through which an external KNX presence detector can be linked to the controller (polarity: Presence exists = "1", no presence exists = "0").
 This object is only visible if the parameter "Room temperature controller function" controller mode is configured as "Switched on" and the parameter "Parameter permanently active" is configured to "No".
 If there is a presence, the controller activates Comfort mode ("KNX" controller mode) or the Comfort profile ("Hotel" controller mode), provided that no higher-level function (e.g. window status) is active. The controller switches to the last specified operating mode or the most recently specified profile, as soon as the presence detector ceases to signal a presence.
 After a bus voltage return or an ETS programming operation (controller reset), the presence function is always inactive.

Function: Window status, operating mode switchover / profile switchover

Object no.	Function	Name	Type	DPT	Flag
58	Window status	Controller - Input	1-bit	1,019	C, (R), W, -, -

1-bit object for the coupling of window contacts.
 Polarity: Window open = "1", window closed = "0".

Object for operating mode change-over

Function: Operating mode change-over

Object no.	Function	Name	Type	DPT	Flag
59	Heating / cooling change-over	Controller - Output	1-bit	1,100	C, (R), -, T, -

1 bit object to transmit the automatically set operating mode of the controller ("Heating" or "Cooling" modes). Object value "1" = Heating; Object value "0" = Cooling.
 After bus voltage return or an ETS programming operation (controller reset), the current operating mode is transmitted via this object. This object is only available in this way when the operating mode switchover takes place automatically (parameter "Switchover between heating and cooling").

Function: Operating mode change-over

Object no.	Function	Name	Type	DPT	Flag
59	Heating / cooling change-over	Controller - Input	1-bit	1,100	C, (R), W, T, -
<p>1 bit object to switch over the operating mode of the controller ("Heating" or "Cooling" modes). Object value "1" = Heating; Object value "0" = Cooling. After a bus voltage return or ETS programming operation (controller reset), the object value is always "0", irrespective of which operating mode is specified via configuration after a reset. This object is only available in this way when the operating mode switchover is to take place manually (not automatically by the controller) (parameter "Switchover between heating and cooling").</p>					

Objects for controller status

Function: Status indication

Object no.	Function	Name	Type	DPT	Flag
60	KNX status operating mode	Controller - Output	1 bytes	20,102	C, R, -,T, -
<p>1-byte object used by the controller to output the current operating mode. This object is generally used to enable controller extensions to display the controller operating mode correctly in the KNX compliant status display. Therefore this object should be connected with controller extensions if the KNX compliant status feedback is not configured. After bus voltage return or an ETS programming operation (controller reset), the current status is transmitted via this object. This object is only available when "Controller status" = "KNX-compliant".</p>					

Function: Status indication

Object no.	Function	Name	Type	DPT	Flag
60	Controller status	Controller - Output	1 bytes	---	C, R, -,T, -
<p>1-byte object used by the controller to output the current state of operation (e. g. to a controller extension). After bus voltage return or an ETS programming operation (controller reset), the current status is transmitted via this object. This object is only available when "Controller status" = "General controller".</p>					

Function: Status indication

Object no.	Function	Name	Type	DPT	Flag
61	Currently active operating mode	Controller - Output	1 bytes	20,102	C, R, -,T, -
<p>1-byte object used by the controller to output the current operating mode, taking the forced position, presence status and window status into account. This object is only visible when the controller mode is configured as "KNX" and the status of the controller is configured as "KNX-conformant".</p>					

Function: Status indication

Object no.	Function	Name	Type	DPT	Flag
61	Currently active profile	Controller - Output	1 bytes	20,102	C, R, -,T, -
<p>1-byte object used by the controller to output the current profile, taking the forced position, presence status and window status into account. This object is only visible when the controller mode is configured as "Hotel" and the status of the controller is configured as "KNX-conformant".</p>					

Function: Status indication

Object no.	Function	Name	Type	DPT	Flag
62	Currently active Standby profile	Controller - Output	1-bit	1,001	C, R, -,T, -
<p>1-bit object, using which the controller differentiates the current profile between Eco and Standby ("1" = "Standby" profile; "0" = "Eco" profile). This object is only visible when the controller mode is configured as "Hotel".</p>					

Function: Status indication

Object no.	Function	Name	Type	DPT	Flag
68	KNX status	Controller - Output	2 bytes	22,101	C, R, -,T, -
<p>2-byte object that the controller uses to display elementary basic functions in a KNX-harmonised manner. After bus voltage return or an ETS programming operation (controller reset), the current status is transmitted via this object. This object is only available when "Controller status" = "KNX-compliant".</p>					

Function: Status indication

Object no.	Function	Name	Type	DPT	Flag
68	Status signal addition	Controller - Output	1 bytes	---	C, R, -,T, -
<p>1-byte object used by the controller to output the current enlarged state of operation (e.g. to a controller extension). After bus voltage return or an ETS programming operation (controller reset), the current status is transmitted via this object. This object is only available when "Controller status" = "General controller".</p>					

Function: Status indication

Object no.	Function	Name	Type	DPT	Flag
69	KNX status forced operating mode	Controller - Output	1 bytes	20,102	C, R, -,T, -
<p>1-byte object used by the controller to output the operating mode in the event of forced position. This object is generally used to enable controller extensions to display the controller operating mode correctly in the KNX compliant status display. Therefore this object should be connected with controller extensions if the KNX compliant status feedback is not configured.</p> <p>After bus voltage return or an ETS programming operation (controller reset), the current status is transmitted via this object. This object is only visible when the controller mode is configured as "KNX" and the status of the controller is configured as "KNX-conformant".</p>					

Function: Status indication

Object no.	Function	Name	Type	DPT	Flag
69	KNX status forced profile switchover	Controller - Output	1 bytes	20,102	C, R, -,T, -
<p>1-byte object used by the controller to output the profile in the event of forced position. This object is generally used to enable controller extensions to display the controller operating mode correctly in the KNX compliant status display. Therefore this object should be connected with controller extensions if the KNX compliant status feedback is not configured.</p> <p>After bus voltage return or an ETS programming operation (controller reset), the current status is transmitted via this object. This object is only visible when the controller mode is configured as "Hotel" and the status of the controller is configured as "KNX-conformant".</p>					

Objects for heating / cooling signal functions

Function: Heating energy message

Object no.	Function	Name	Type	DPT	Flag
114	Heating indication	Controller - Output	1-bit	1,001	C, R, -,T, -
<p>1-bit object for the controller to report a request for heating energy. Object value = "1": energy request, object value = "0": no energy request. This object is only visible when the parameter "Heating signal" is set to "Yes".</p>					

Function: Cooling energy message

Object no.	Function	Name	Type	DPT	Flag
115	Cooling indication	Controller - Output	1-bit	1,001	C, R, -,T, -
<p>1-bit object for the controller to report a request for cooling energy. Object value = "1": energy request, object value = "0": no energy request. This object is only visible when the parameter "Cooling signal" is set to "Yes".</p>					

Objects for controller disabling functions

Function: Disable controller

Object no.	Function	Name	Type	DPT	Flag
98	Disable controller	Controller - Input	1-bit	1,001	C, (R), W, -, -

1-bit object for deactivating the controller (activating dew point operation). Polarity: Controller deactivated = "1", controller activated = "0". This object is only visible if the parameter "Switch off controller (dew point operation)" is set to "Via bus".

Object for heating command value output and combined valve heating/cooling

Function: Command value

Object no.	Function	Name	Type	DPT	Flag
100	Command value for heating	Controller - Output	1 bytes	5,001	C, R, -,T, -

1-byte object to output the continuous command value of the heating mode. This object is only available in this way if the type of feedback control is configured to "Continuous PI control".

Function: Command value

Object no.	Function	Name	Type	DPT	Flag
100	Command value heating (PWM)	Controller - Output	1-bit	1,001	C, R, -,T, -

1-bit object to output the PWM command value of the heating mode. This object is only available in this way if the type of feedback control is configured to "Switching PI control (PWM)".

Function: Command value

Object no.	Function	Name	Type	DPT	Flag
100	Command value heating/cooling	Controller - Output	1 bytes	5,001	C, R, -,T, -

1-byte object to output the combined continuous command value of the heating and cooling mode. This object is only available in this way if the command values for heating and cooling mode are output to a shared object (parameter-dependent). The type of feedback control must also be configured to "Continuous PI control".

Function: Command value

Object no.	Function	Name	Type	DPT	Flag
100	Command value heating/cooling (PWM)	Controller - Output	1-bit	1,001	C, R, -,T, -

1-bit object to output the combined PWM command value of the heating and cooling mode. This object is only available in this way if the command values for heating and cooling mode are output to a shared object (parameter-dependent). The type of feedback control must also be configured to "Switching PI control (PWM)".

Object for command value output, cooling

Function: Command value

Object no.	Function	Name	Type	DPT	Flag
102	Command value cooling	Controller - Output	1 bytes	5,001	C, R, -,T, -

1-byte object to output the continuous command value of the cooling mode. This object is only available in this way if the type of feedback control is configured to "Continuous PI control".

Function: Command value

Object no.	Function	Name	Type	DPT	Flag
102	Command value cooling (PWM)	Controller - Output	1-bit	1,001	C, R, -,T, -

1-bit object to output the PWM command value of the cooling mode. This object is only available in this way if the type of feedback control is configured to "Switching PI control (PWM)".

Object for additional PWM heating command value output and combined valve PWM additional heating/cooling

Function: Command value

Object no.	Function	Name	Type	DPT	Flag
104	PWM command value for heating	Controller - Output	1 bytes	5,001	C, R, -,T, -

1-byte object to output the internal continuous command value of a PWM controller of the heating mode. This object is only available in this way if the type of feedback control is configured to "Switching PI control (PWM)". In addition to the switching 1 bit command value of the PWM, the calculated continuous command value of the controller can also be transmitted to the bus and displayed, e.g. in a visualisation.

Function: Command value

Object no.	Function	Name	Type	DPT	Flag
104	PWM command value heating/cooling	Controller - Output	1 bytes	5,001	C, R, -,T, -

1-byte object to output the combined continuous command value of a PWM controller of the heating and cooling mode. This object is only available in this way if the command values for heating and cooling mode are output to a shared object (parameter-dependent). The type of feedback control must also be configured to "Switching PI control (PWM)". In addition to the switching 1 bit command value of the PWM, the calculated continuous command value of the controller can also be transmitted to the bus and displayed, e.g. in a visualisation.

Object for additional command value output, PWM cooling

Function: Command value

Object no.	Function	Name	Type	DPT	Flag
106	PWM command value for cooling	Controller - Output	1 bytes	5,001	C, R, -,T, -
<p>1-byte object to output the internal continuous command value of a PWM feedback controller of the cooling mode. This object is only available in this way if the type of feedback control is configured to "Switching PI control (PWM)". In addition to the switching 1 bit command value of the PWM, the calculated continuous command value of the controller can also be transmitted to the bus and displayed, e.g. in a visualisation.</p>					

Object for command value limit

Function: Command value limit

Object no.	Function	Name	Type	DPT	Flag
108	Command value limit	Controller - Input	1-bit	1,001	C, (R), W, -, -
<p>1-bit object for requirement-orientated activating and deactivating of a command value limit. The telegram polarity is fixed: "0" = Command value limit inactive, "1" = Command value limit active. Updates of the object from "1" to "1" or "0" to "0" do not produce a reaction.</p> <p>It is possible to have the actuator activate the command value limit automatically after bus voltage return or an ETS programming operation. The status of the command value limit is not then automatically tracked in the communication object.</p> <p>This object is only visible when the parameter "Command value limit" is set to "Can be activated via object".</p>					

Object for outputting the setpoint temperature

Function: Set temperature

Object no.	Function	Name	Type	DPT	Flag
64	Set temperature	Controller - Output	2 bytes	9,001	C, R, -,T, -
<p>2-byte object for the output of the current temperature setpoint. Depending on the operating mode, the possible range of values is limited by the configured frost protection and/or heat protection temperature.</p> <p>The temperature value is always output in the format "°C".</p> <p>After bus voltage return or an ETS programming operation (controller reset), the current setpoint temperature is transmitted via this object.</p>					

Object for basic setpoint shift

Function: Basic setpoint shift

Object no.	Function	Name	Type	DPT	Flag
66	Current setpoint shifting	Controller - Output	1 bytes	6,010	C, R, -, T, -

1-byte object for giving feedback on the current setpoint shift for evaluation, e.g. by a controller extension. The value of a counter value in the communication object is dependent on the parameter "Setpoint shift value". The value "0" means that no shift is active. The value is depicted in a double complement in the positive and negative direction.

After bus voltage return or an ETS programming operation (controller reset), the current value for the basic setpoint shift is transmitted via this object. Since the value for the basic setpoint shift is stored exclusively in volatile memory, the shift is always "0" immediately after a bus voltage return or an ETS programming operation.

This object is only visible in the application program Temperature controller fan coil from version 1.2 when the parameter "Type of setpoint shift" is set to "Via levels (DPT 6.010)".

Function: Basic setpoint shift

Object no.	Function	Name	Type	DPT	Flag
67	Preset setpoint shifting	Controller - Input	1 bytes	6,010	C, (R), W, -, -

1-byte object for setting a basic setpoint shifting, e.g. via a controller extension. The value of a counter value in the communication object is dependent on the parameter "Setpoint shift value". The value "0" means that no shift is active. The value is depicted in a double complement in the positive and negative direction.

In case the limits of the value range are exceeded by the preset external value, the controller will automatically reset the received value to the minimum and maximum limits.

This object is only visible in the application program Temperature controller fan coil from version 1.2 when the parameter "Type of setpoint shift" is set to "Via levels (DPT 6.010)".

Function: Basic setpoint shift

Object no.	Function	Name	Type	DPT	Flag
94	Current setpoint shifting	Controller (<i>Name</i>) - Output	2 bytes	9,002	C, R, -, T, A

2-byte object for giving feedback on the current setpoint shift in Kelvin, for evaluation, e.g. by a controller extension. The value "0" means that no shift is active. After bus voltage return or an ETS programming operation (controller reset), the current value for the basic setpoint shift is transmitted via this object. Since the value for the basic setpoint shift is stored exclusively in volatile memory, the shift is always "0" immediately after a bus voltage return or an ETS programming operation.

This object is only visible in the application program Temperature controller fan coil from version 1.2 when the parameter "Type of setpoint shift" is set to "Via offset (DPT 9.002)".

Function: Basic setpoint shift

Object no.	Function	Name	Type	DPT	Flag
95	Preset setpoint shifting	Controller (<i>Name</i>) - Input	2 bytes	9,002	C, -,W, -, U

2-byte object for setting a basic setpoint shifting in Kelvin, e.g. via a controller extension. The value "0" means that no shift is active. The values can be specified between -670760 K and 670760 K.

In case the limits of the value range (parameter "Adjustment of the basic setpoint temperature ...") are exceeded by the preset external value, the controller will automatically reset the received value to the minimum and maximum limits.

This object is only visible in the application program Temperature controller fan coil from version 1.2 when the parameter "Type of setpoint shift" is set to "Via offset (DPT 9.002)".

Object for detecting the outdoor temperature

Function: Outdoor temperature

Object no.	Function	Name	Type	DPT	Flag
70	Outdoor temperature	Controller - Input	2 bytes	9,001	C, (R), W, -, -

2-byte object for detecting the outdoor temperature. The received value is used solely for limiting the setpoint temperature in cooling mode.

Possible range of values: -99.9 °C to +99.9 °C.

The temperature value must always be specified in the format "°C".

This object is only visible when "Setpoint temperature limit in cooling operation" = "Only difference to outdoor temperature" or "Max. setpoint temperature and difference to outdoor temperature" is available.

Object for limiting the setpoint temperature

Function: Setpoint temperature limit

Object no.	Function	Name	Type	DPT	Flag
71	Limit of cooling setpoint temperature	Controller - Input	1-bit	1,001	C, (R), W, -, -

1-bit object for activating the setpoint temperature limit. Polarity:

Setpoint temperature limit ON = "1"; Setpoint temperature limit OFF = "0".

This communication object is only available when the setpoint temperature limit intends activation via an object.

Object for temperature drop detection

Function: Temperature drop detection

Object no.	Function	Name	Type	DPT	Flag
127	Temperature drop detection	Controller - Output	1-bit	1,019	C, R, -,T, -
<p>1-bit object to signal a temperature drop on the KNX. This object is available for the "KNX" controller mode and the "Hotel" controller mode.</p> <p>In the "KNX" controller mode, this object is only visible when the "Frost/heat protection" parameter is set to "Automatic frost protection operation". The device signals a temperature drop, if the temperature falls by a configurable value in K in a specific time in min (parameter "Automatic frost protection temperature drop").</p> <p>In the "Hotel" controller mode, this object is only visible when the ""Building Protection" profile" parameter is set to "Automatic Building Protection". The device signals a temperature drop, if the temperature falls by a configurable value in K in a specific time in min (parameter "Automatic Building Protection temperature drop").</p>					

Objects for fan control

Function: Fan control

Object no.	Function	Name	Type	DPT	Flag
135	Ventilation, auto- matic/manual	Controller - Input	1-bit	1,001	C, (R), W, -, -
<p>1-bit object to change-over the operating mode of the fan controller (configurable polarity). When the operating mode is changed over using a button function, a telegram matching the current status is transmitted to the bus.</p>					

Function: Fan control

Object no.	Function	Name	Type	DPT	Flag
136	Ventilation, fan level 1-3	Controller - Output	1 bytes	5,010	C, R, -,T, -
<p>1-byte object for value-guided activation of the fan levels. This object is only available in this way when the fan control is to take place over 1 byte (parameter-dependent).</p>					

Function: Fan control

Object no.	Function	Name	Type	DPT	Flag
136	Ventilation, fan level 1	Controller - Output	1-bit	1,001	C, R, -,T, -
<p>1-bit object for switching activation of the first fan level. This object is only available in this way when the fan control is to take place over 3 x 1 bit and at least one fan level is enabled (parameter-dependent).</p>					

Function: Fan control

Object no.	Function	Name	Type	DPT	Flag
137	Ventilation, fan level 2	Controller - Output	1-bit	1,001	C, R, -,T, -

1-bit object for switching activation of the second fan level. This object is only available when the fan control is to take place over 3 x 1 bit and at least two fan levels are enabled (parameter-dependent).

Function: Fan control

Object no.	Function	Name	Type	DPT	Flag
138	Ventilation, fan level 3	Controller - Output	1-bit	1,001	C, R, -,T, -

1-bit object for switching activation of the third fan level. This object is only available when fan control is to take place over 3 x 1 bit and three fan levels are enabled (parameter-dependent).

Function: Fan control

Object no.	Function	Name	Type	DPT	Flag
145	Ventilation, forced position	Controller - Input	1-bit	1,001	C, (R), W, -, -

1-bit object for activation of the fan forced position. Polarity:
 Forced position ON = "1"; Forced position OFF = "0".

Function: Fan control

Object no.	Function	Name	Type	DPT	Flag
146	Ventilation, level limit	Controller - Input	1-bit	1,001	C, (R), W, -, -

1-bit object for activation of the fan level limitation. Polarity:
 Fan level limitation ON = "1"; Fan level limitation OFF = "0".

Function: Fan control

Object no.	Function	Name	Type	DPT	Flag
147	Ventilation, fan pro- tection	Controller - Input	1-bit	1,001	C, (R), W, -, -

1-bit object for activating the fan protection. Polarity:
 Fan protection ON = "1" / Fan protection OFF = "0".

Function: Fan control

Object no.	Function	Name	Type	DPT	Flag
148	Ventilation visualisa- tion	Controller - Output	1 bytes	5,010	C, R, W, -, -

1-byte object for additional value-guided acknowledgement of the active fan level.
 Value meaning: "0" = Fan OFF, "1" = level 1 active, "2" = level 2 active,
 "3" = level 3 active.

Function: Fan control

Object no.	Function	Name	Type	DPT	Flag
149	Specification, ventilation, automatic/manual	Controller - Input	1-bit	1,001	C, (R), W, -, -

1-bit object to specify the fan operating mode ("1" = Auto; "0" = Manual).

Function: Fan control

Object no.	Function	Name	Type	DPT	Flag
150	Feedback, ventilation, automatic/manual	Controller - Output	1-bit	1,001	C, R, -, T, -

1-bit object to feed back the current fan operating mode ("1" = Auto; "0" = Manual).

Function: Fan control

Object no.	Function	Name	Type	DPT	Flag
151	Fan level specification	Controller - Input	1 bytes	5,010	C, (R), -, -, A

1-byte object for specifying the fan level.

Function: Fan control

Object no.	Function	Name	Type	DPT	Flag
152	Feedback for fan level	Controller - Output	1 bytes	5,010	C, R, -, T, -

1-byte object for feeding back the current fan level.

Object for rotation angle conversion

Function: control of rotating valves

Object no.	Function	Name	Type	DPT	Flag
160	Output voltage rotation angle conversion	Controller - Output	2 bytes	9,020	C, (R), -, T, -

2-byte object for output of the voltage for activating a control ball valve.

This object is only visible in the application program Temperature controller fan coil from version 1.2 when the parameter "Rotation angle conversion" is set to "Enabled".

11 Functional description of the controller extension

The room temperature controller function can be switched on or be configured as a controller extension.

A controller can be used for single-room temperature control. Depending on the operating mode, current temperature setpoint and room temperature, command values for heating or cooling control and fan controller can be sent to the KNX. These command values are usually then converted by a suitable KNX actuator, e.g. heating or switching actuators or directly by bus-compatible actuating drives, evaluated and converted to physical variables for air conditioning control.

The controller of the device can either work as a main controller or as a controller extension. As the main controller, the room temperature controller function is fully switched on and the control algorithm activated. Only the main controller transmits control value telegrams. A controller extension itself is not involved in the temperature regulating process. With it, the user can operate the single-room controller, i.e. the main controller from different places in the room. In this way, any number of operating extensions can be set up.

In this chapter, the functions of the room temperature controller are described as a controller extension.

11.1 Connection to room temperature controller

Function

The controller extension can be activated to control a KNX room temperature controller. The controller extension function is enabled using the "Controller extension" setting of the parameter "Room temperature controller" in the "General -> Basic settings" parameter node.

The controller extension itself is not involved in the regulating process. With it, the user can operate the single-room regulation from different places in the room. It can also be used to adjust central heating control units which are located, for instance, in a sub-distribution unit.

Typical KNX room temperature controllers generally offer different ways of influencing or visualising the room temperature control:

- Switching over between different operating modes ("KNX" controller mode) or profiles ("Hotel" controller mode) with different setpoint temperatures assigned to each mode in the controller.
- Fan control specifications (e.g. specification of the fan level).
- Readjustment of the setpoint temperature in levels which are referred in each case to the configured setpoint temperature of the current operating mode (basic setpoint shift).

The device permits by means of its sensor buttons the complete control of an external room temperature controller by changing the operating mode or profile or by readjusting the setpoint shift (cf. the following sub-chapters).

All the input objects of the controller extension (RNST - Input) update themselves automatically after a reset or an ETS programming operation, provided that the I flags are set in the ETS. The inputs can also then be polled by the device if the I flags are not set. For this, the parameter "Value request from controller extension?" must be set to "Yes".

- i** If the I flags are set and the parameter "Value request from controller extension?" is set to "Yes", then the device updates all the input objects of the controller extension twice after a reset or an ETS programming operation. To update the input objects of the controller extension, either the I flags must be set or the parameter "Value request from controller extension?" must be set to "Yes" to reduce the data traffic.

Updating is effected by means of a ValueRead telegram to the room temperature controller. This must answer the request with a ValueResponse telegram. If the device does not receive all or some of the answers, the affected objects are initialised with "0". In this case, the objects must first be actively rewritten by the bus after a reset.

Besides the operating function, the controller extension also possesses a display function. As on the main controller, various items of status information of the temperature controller can be shown on the device display. As the displayed states and information and also some operating functions are strongly dependent on the parameterisation of the main controller, the controller extension must also be configured and thus match the functions of the main controller. These functions are matched by parameters in the parameter node "Controller extension".

Communication objects

The controller extension can work properly only if all extension objects are linked with the objects of the same function in the main controller. The controller extension with the objects exists only once in the device (indication in the object name "RNST") Objects with the same function can be linked together using identical group addresses, meaning that multiple controller extensions can affect one main controller.

- i** The actual room temperature can be detected by the communication objects of the room temperature measurement system, which are also available in the controller extension, and then shown in the display.

11.2 Operating functions

The controller extension supports either four or five different energy levels, depending on the controller mode to which it is configured. The "Controller mode" parameter on the "General -> Basic settings" parameter page configures the controller extension to the desired mode.

In the "KNX" controller mode, the energy levels are termed operating modes. The

controller or the controller extension possesses the operating modes "Comfort mode", "Standby", "Night" and "Frost/heat protection".

In the "Hotel" controller mode, the energy levels are termed profiles. The controller or the controller extension possesses the profiles "Comfort", "Comfort-", "Eco", "Standby" and "Building Protection".

Irrespective of the configured controller mode, the device uses the same icons for showing the energy level in the display.

Operating mode switchover ("KNX" controller mode)

In the "KNX" controller mode, the switchover of the controller operating mode can be effected in accordance with the standard function block for room temperature controllers defined in the KNX handbook with two 1-byte communication objects. The operating mode can be switched over with the normal and with the forced objects. The "RNST - Output operating mode switchover" object offers a selection between the following operating modes:

- Comfort mode
- Standby mode
- Night operation
- Frost/heat protection mode

The "RNST - Output forced object operating mode" communication object has a higher priority. It permits forced switching between the following modes of operation:

- Auto (normal operating mode switchover)
- Comfort mode
- Standby mode
- Night operation
- Frost/heat protection mode



Notes on multiple selection:

In order to ensure that a change from one operating mode or profile to another works properly even from different locations, the operating mode/profile objects of the controller and those of all controller extensions must be interlinked and have their "Write" flag set.

By checking the linked operating mode/profile switchover object, the controller extension knows which of the possible operating modes or profiles is active.

Based on this information, the device switches over to the corresponding operating mode or profile when a sensor button is pressed.

Profile switchover ("Hotel" controller mode)

In the "Hotel" controller mode, the switchover of the controller profile can be effected with two communication objects. The "RNST - Output profile switchover" object offers a selection between the following profiles:

- Comfort

- Comfort-
- Eco
- Building Protection

The communication object "RNST - Output profile switchover Standby" differentiates the object value of the "RNST - Output profile switchover" between the "Eco" and "Standby" profiles.

- Eco
- Standby



Notes on multiple selection:

In order to ensure that a change from one operating mode or profile to another works properly even from different locations, the operating mode/profile objects of the controller and those of all controller extensions must be interlinked and have their "Write" flag set.

By checking the linked operating mode/profile switchover object, the controller extension knows which of the possible operating modes or profiles is active.

Based on this information, the device switches over to the corresponding operating mode or profile when a sensor button is pressed.

Setpoint shift

The setpoint shift is another available function of the controller extension.



The "Type of setpoint shift" parameter and the 2-byte communication objects (according to KNX DPT 9.002) are only available in the application program Temperature controller fan coil from version 1.2.

Type of setpoint shift

The device provides two options for setpoint shifting. Depending on the setting of the parameter "Type of setpoint shift", the shift takes place via the 2-byte communication object "Setpoint shift specification" (acc. to KNX DPT 9.002) or via the 1-byte-communication object "Setpoint shift specification" (acc. to KNX DPT 6.010).

The setting "Via offset (DPT 9.002)" defines the temperature difference in Kelvin by which the setpoint temperature will be shifted up or down when the button is pressed. For a setpoint value shift, the controller extension makes use of the two communication objects "Setpoint shift specification" and "Current setpoint shift". The "Current setpoint shift" communication object informs the extension about the current state of the room temperature controller. Based on this value and the respective parameter, the controller extension determines the new level size which it transmits via the "Setpoint shift specification" communication object to the room temperature controller.

With the "Via levels (DPT 6.010)" setting, only the direction of the setpoint shift on the extension is defined. For a setpoint value shift, the controller extension makes use of the two communication objects "Setpoint shift specification" and "Current setpoint shift". The "Current setpoint shift" communication object informs the extension about the current state of the room temperature controller. Based on this value and the re-

spective parameter, the controller extension determines the new level size which it transmits via the "Setpoint shift specification" communication object to the room temperature controller.

The sensor buttons increase or reduce the value of the setpoint shift once on each button press by the value specified.

The setpoint shift is shown in absolute values as a temporary display in the first operating level. To ensure that the reaction time between pressing a sensor button and the temporary display of the setpoint shift is not too long, the controller extension takes the most recently received setpoint temperature as the basis and calculates the shifted absolute setpoint. After the main controller has fed back the current setpoint temperature to the controller extension, the display may be corrected.

Communication with main controller:

In order to enable the controller extension to effect a setpoint shift in a room temperature controller, the controller must have input and output objects for setpoint shifts. In this case, the output object of the controller must be linked with the input object of the extension unit and the input object of the controller must be linked with the output object of the extension via an independent group address.

The objects in the controller and in the controller extension unit must have the same data point type and value range. A setpoint shift is interpreted by count values data point type 6.010 (signed integer) or by floating point values data point type 9.002 (temperature difference): a shift in positive direction is expressed by positive values whereas a shift in negative direction is represented by negative object values. An object value of "0" means that no setpoint shift has been activated.

Using the "RNST - Input current setpoint shift" object, the extensions are enabled to determine the current setpoint shift position. Starting from the value of the communication object, each press of the sensor button on an extension will adjust the setpoint in the corresponding direction by one count value level. Each time the setpoint is adjusted, the new shift is transmitted to the room temperature controller via the "RNST - Output setpoint value specification" object. The controller itself checks the received value for the minimum and maximum temperature limits (siehe Kapitel "Temperature setpoints" ▶ Page 73) and adjusts the new setpoint shift if the values are valid. When the new count value is accepted as valid, the controller transfers this value to its output object for setpoint shifting and retransmits the value to the extension as positive feedback.

Due to the standard data point type used as the output and input object of the controller extension and the weighting of the individual level by the controller itself, each extension unit is able to determine whether a shift took place, in which direction it took place and by how many levels the setpoint was shifted. This requires that the communication objects are connected on all controller extensions and the controller.

The information for the step value as feedback from the controller enables the extension to continue the adjustment anytime at the right point. The extension units can likewise react to a reset of the setpoint shifting function by the controller.

Fan controller

Fan control is another available function of the controller extension. It uses four communication objects. With this extension function, it is possible to switch between the automatic and manual fan control modes by pressing the sensor buttons. In addition, the fan level can be shifted. Operation of the extension is generally the same as the operation of the main controller.

Communication with main controller:

In order to enable the controller extension to effect fan control in a room temperature controller, the controller must have input and output objects for fan control. In this case, the output objects of the controller must be linked with the input objects of the extension unit and the input objects of the controller must be linked with the output objects of the extension via an independent group address.

The extensions detect the currently set fan control level via the object "RNST - Input fan level feedback". Starting from the value of the communication object, each press of the sensor button on an extension will adjust the fan level by one level. Each time the fan level is adjusted, the new shift is transmitted to the room temperature controller via the "RNST - Output fan level specification" object. When the new fan level is accepted as valid, the controller transfers this value to its output object for fan control and retransmits the value to the extension as positive feedback.

11.3 Display functions

Indication of the controller operating mode

The controller extension can indicate the current operating mode of the controller in the display. The display is as on the controller itself.

Icon	Operating mode	Profile
No icon	Comfort mode	Comfort
☆	Standby mode	Comfort-
🌙	Night operation	Eco
🔌	---	Standby
❄️	Frost/heat protection mode	Building Protection

This display information is obtained from the communication objects "RNST - Input currently active operating mode" or "RNST - Input currently active profile". These objects should be connected to the main controller objects with the same function!

It is not possible to use the display information to distinguish whether the switchover has taken place via a forced object or via a 'normal' object. It is possible to switch over the operating mode or the profile using the sensor buttons of the controller extension.

i It is not possible to switch over the operating mode or profile in the menu level on a controller extension in local control.

Fan levels display

As on a main controller, a controller extension can also indicate the current fan level of a fan controller in the display. There is no difference in the activation function of the fan icon with the main controller function.

Fan control status - Display









State of the fan control	Status display on the display
Automatic operation, Fan level OFF	AUTO  □□□
Automatic operation, Fan level 1	AUTO  ■□□
Automatic operation, Fan level 2	AUTO  ■■□
Automatic operation, Fan level 3	AUTO  ■■■
Manual operation, Fan level OFF	OFF  □□□
Manual operation, Fan level 1	LOW  ■□□
Manual operation, Fan level 2	MID  ■■□
Manual operation, Fan level 3	HIGH  ■■■

Image 53: Fan control status in the display

For the fan level indication to function, the communication object "RNST - Input ventilation visualisation" must be connected to the object of the same function of the main controller.

The number of fan levels must be set on the controller extension in accordance with the main controller.

11.4 Behaviour after a device restart

The different indication and operating functions of the controller extension are controlled via different communication objects as described in the previous chapters. A main controller must transmit the current status to the extensions, i.e. updating the communication objects so that, after a programming operation or after the return of bus voltage, all the status information is available for the initialisation of the extension. This takes place automatically for some objects during the initialisation of the main controller.

To ensure that all the objects are initialised correctly, some communication objects of the controller extension can also initialise automatically after a device restart as an option. For this, the parameter "Value request from controller extension?" the parameter node "Room temperature control" can be set to "Yes". The update takes place after a reset by means of a ValueRead telegram to the room temperature controller. This must answer the request with a ValueResponse telegram. If the extension does not receive all or some of the answers, the affected objects are initialised with "0". In this case, after a reset the objects must first be actively rewritten by the bus by other bus subscribers, e.g. through automatic transmission by the main controller. This is also always the case when the parameter "Value request from controller extension?"

is configured to "No".

The automatic update takes place for all the transmitting objects with the name "RNST - Input".

- i** During commissioning, all extensions should be put into operation first. Only then should the main controller be connected and programmed. For larger KNX installations where the extensions are sometimes distributed over several lines, the remaining lines should also be initialized after a reset of one line.

11.5 Parameter group "controller extension"

Name of the controller extension	Free text
The text entered in this parameter is applied to the name of the communication objects and is used for labelling the controller extension in the ETS parameter window. The text is not programmed in the device.	
Value request from controller extension?	Yes No
To ensure that all the objects are updated correctly, some communication objects of the controller extension can also initialise automatically after a device restart. For this, this parameter can be set to "Yes". The update then takes place after a reset by means of a ValueRead telegram to the room temperature controller. This must answer the request with a ValueResponse telegram.	
Operating mode	Heating Cooling Heating and cooling
Besides the operating function, the controller extension also possesses a display function. As on the main controller, various items of status information of the temperature controller can be shown on the device display. As the displayed states and information and also some operating functions are strongly dependent on the parameterisation of the main controller, the controller extension must also be configured and thus match the functions of the main controller. It should be ensured that the settings match those of the main controller.	
Change-over between heating and cooling	automatic via object (heating/cooling change-over)
In a configured mixed mode it is possible to switch over between heating and cooling. "Automatic": Depending on the operating mode and the room temperature, the change-over takes place automatically. Via object (heating/cooling change-over): The change-over takes place only via the object "Heating / cooling change-over".	

Type of setpoint shift	Via levels (DPT 6.010) Via offset (DPT 9.002)
Depending on the setting of the parameter "Type of setpoint shift", the shift takes place via the 2-byte communication object "Setpoint shift specification" (acc. to KNX DPT 9.002) or via the 1-byte-communication object "Setpoint shift specification" (acc. to KNX DPT 6.010).	
Value of the setpoint shift	0.5 K 1 K 1.5 K 2 K
The temperature difference is defined in Kelvin here by which the setpoint temperature will be shifted up or down when the button is pressed. For a setpoint value shift, the controller extension makes use of the two communication objects "Setpoint shift specification" and "Current setpoint shift". The "Current setpoint shift" communication object informs the extension about the current state of the room temperature controller. Based on this value and the respective parameter, the controller extension determines the new level size which it transmits via the "Setpoint shift specification" communication object to the room temperature controller.	
Number of fan levels	1 fan level 2 fan levels 3 fan levels
The fan controller of the controller extension supports up to 3 fan level outputs, for which the actually used number of levels (1...3) is set using this parameter.	

11.6 Object table "controller extension"

Objects for the controller extension:

Function: controller extension

Object no.	Function	Name	Type	DPT	Flag
52	Operating mode switchover	RNST - Output	1 bytes	20,102	C, R, -,T, -
1-byte object for changing over a room temperature controller between the Standby, Night and Frost/heat protection operating modes. This object is only visible when the controller mode is configured as "KNX".					

Function: controller extension

Object no.	Function	Name	Type	DPT	Flag
52	Profile switchover	RNST - Output	1 bytes	20,102	C, R, -,T, -
1-byte object for changing over a room temperature controller between the Comfort-, Eco and Standby profiles. This object is only visible when the controller mode is configured as "Hotel".					

Function: controller extension

Object no.	Function	Name	Type	DPT	Flag
59	Heating / cooling change-over	RNST - Output	1-bit	1,100	C, R, -,T, -
<p>1 bit object to switch over the operating mode of the controller ("Heating" or "Cooling" modes). Object value "1" = Heating; Object value "0" = Cooling. This object is only available in this way when the operating mode switchover is to take place manually (not automatically by the controller) (parameter "Switchover between heating and cooling").</p>					

Function: controller extension

Object no.	Function	Name	Type	DPT	Flag
61	Currently active operating mode	RNST - Input	1 bytes	20,102	C, (R), W, T, -
<p>1-byte object, via which the controller extension can receive the current operating mode. This object is only visible when the controller mode is configured as "KNX".</p>					

Function: controller extension

Object no.	Function	Name	Type	DPT	Flag
61	Currently active profile	RNST - Input	1 bytes	20,102	C, (R), W, T, -
<p>1-byte object, via which the controller extension can receive the current profile. This object is only visible when the controller mode is configured as "Hotel".</p>					

Function: controller extension

Object no.	Function	Name	Type	DPT	Flag
62	Currently active Standby profile	RNST - Input	1-bit	1,001	C, (R), W, T, -
<p>1-bit object, using which the controller extension differentiates the current profile between Eco and Standby ("1" = "Standby" profile; "0" = "Eco" profile). This object is only visible when the controller mode is configured as "Hotel".</p>					

Function: controller extension

Object no.	Function	Name	Type	DPT	Flag
64	Set temperature	RNST - Input	2 bytes	9,001	C, (R), W, T, -
<p>2-byte object for the reception of the current temperature setpoint. The device receives the temperature value in the "°C" format.</p>					

Function: controller extension

Object no.	Function	Name	Type	DPT	Flag
66	Current setpoint shifting	RNST - Input	1 bytes	6,010	C, (R), W, T, -

1-byte object used by the extension unit for receiving the current setpoint shift of the room temperature controller.
 $x \leq 0 \leq y$ (0 = no shift active); integral numbers
 The possible range of values (x to y) is fixed by the setpoint adjusting range to the 'upper limit' or to the 'lower limit' (configurable) in combination with the level value on the room temperature controller.
 This object is only visible in the application program Temperature controller fan coil from version 1.2 when the parameter "Type of setpoint shift" is set to "Via levels (DPT 6.010)".

Function: controller extension

Object no.	Function	Name	Type	DPT	Flag
67	Preset setpoint shifting	RNST - Output	1 bytes	6,010	C, R, -, T, -

1-byte object for presetting a basic setpoint shift for a controller.
 $x \leq 0 \leq y$ (0 = no shift active); integral numbers
 Value object + 1 (increase level value)
 Value object - 1 (decrease level value)
 The possible range of values (x to y) is fixed by the setpoint adjusting range to the 'upper limit' or to the 'lower limit' (configurable) in combination with the level value on the room temperature controller.
 This object is only visible in the application program Temperature controller fan coil from version 1.2 when the parameter "Type of setpoint shift" is set to "Via levels (DPT 6.010)".

Function: Basic setpoint shift

Object no.	Function	Name	Type	DPT	Flag
94	Current setpoint shifting	RNST (<i>Name</i>) - Input	2 bytes	9,002	C, -, W, T, U

2-byte object for giving feedback on the current setpoint shifting in Kelvin. The value "0" means that no shift is active .
 This object is only visible in the application program Temperature controller fan coil from version 1.2 when the parameter "Type of setpoint shift" is set to "Via offset (DPT 9.002)".

Function: Basic setpoint shift

Object no.	Function	Name	Type	DPT	Flag
95	Preset setpoint shifting	RNST (<i>Name</i>) - Output	2 bytes	9,002	C, R, T, -, -

2-byte object for presetting a basic setpoint shift in Kelvin. The value "0" means that no shift is active. The values can be specified between -670760 K and 670760 K.
This object is only visible in the application program Temperature controller fan coil from version 1.2 when the parameter "Type of setpoint shift" is set to "Via offset (DPT 9.002)".

Function: controller extension

Object no.	Function	Name	Type	DPT	Flag
68	KNX status	RNST - Input	2 bytes	22,101	C, (R), W, T, -

2-byte object that the controller uses to display elementary basic functions in a KNX-harmonised manner.
Only when "Controller status" = "KNX compliant".

Function: controller extension

Object no.	Function	Name	Type	DPT	Flag
83	Standby profile switchover	RNST - Output	1 bytes	1,001	C, R, -, T, -

1-bit object for switchover to the "Standby" profile. This object is only visible when the controller mode is configured as "Hotel".

Function: controller extension

Object no.	Function	Name	Type	DPT	Flag
111	Actual-temperature	RNST - Input	2 bytes	9,001	C, (R), W, T, -

2-byte object for the detection of the actual temperature. The received value is used solely for the display. Possible range of values: -99.9 °C to +99.9 °C.
The temperature value must always be specified in the format "°C".

Function: controller extension

Object no.	Function	Name	Type	DPT	Flag
148	Ventilation visualisation	RNST - Input	1 bytes	5,010	C, (R), W, T, -

1-byte object for additional value-guided acknowledgement of the active fan level. Value meaning: "0" = Fan OFF, "1" = level 1 active, "2" = level 2 active, "3" = level 3 active.

Function: controller extension

Object no.	Function	Name	Type	DPT	Flag
149	Specification, ventilation, automatic/manual	RNST - Output	1-bit	5,010	C, R, -,T, -
1-bit object to specify the fan operating mode ("1" = Auto; "0" = Manual).					

Function: controller extension

Object no.	Function	Name	Type	DPT	Flag
150	Feedback, ventilation, automatic/manual	RNST - Input	1-bit	5,010	C, (R), W, T, -
1-bit object to feed back the current fan operating mode ("1" = Auto; "0" = Manual).					

Function: controller extension

Object no.	Function	Name	Type	DPT	Flag
151	Fan level specification	RNST - Output	1-bit	5,010	C, R, -,T, -
1-byte object for specifying the fan level.					

Function: controller extension

Object no.	Function	Name	Type	DPT	Flag
152	Feedback for fan level	RNST - Input	1-bit	5,010	C, (R), W, T, -
1-byte object for feeding back the current fan level.					

12 Functional description of the status LED

The device possesses a Status LED (see figure 1). The Status LED has three colours and (red, green or blue). The Status LED functions as a programming LED, operation LED and actuation LED.

Function of Programming LED

When the programming mode is active, the Status LED flashes blue at a frequency of around 4 Hz. If the device is unloaded or contains no - or an incorrect - application program, then the Status LED flashes blue at a frequency of around 0.75 Hz.

Function of operation LED

The Status LED as an operation LED can be permanently on or off or alternatively be switched via a communication object. The operation LED lights up red or green according to the set operating mode ("KNX" controller mode) or profile ("Hotel" controller mode).

Currently active operating mode ("KNX" controller mode)	Currently active profile („Hotel“ controller mode)	Parameter setting „Function of the operation LED“	Object value „Activate / deactivate operation LED	Status and colour of the Status LED in the function as the operation LED
Comfort mode, Standby mode or Night mode	Comfort, Comfort- or Eco	Always off	X	Off
		On	X	Green
		Red or off	X	Off
		Green or off	X	Green
		Control via Object	On	Green
			Off	Off
Frost/heat protection operation	Standby or Building Protection	Always off	X	Off
		On	X	Red
		Red or off	X	Red
		Green or off	X	Off
		Control via Object	On	Red
			Off	Off

Image 54: Status and illumination colour of the Status LED in the function as the operation LED

X Status irrelevant

Function of actuation LED

The Status LED as an actuation LED can be permanently on or off or alternatively flash green when a sensor button is pressed. Then, the actuation LED flashes for the period of actuation (plus 100 ms run-on time) with a frequency of around 4 Hz.

12.1 Object table "operation and actuation LED"

Function: operation LED

Object no.	Function	Name	Type	DPT	Flag
1	Activate / deactivate operation LED	LED - Input	1-bit	1,001	C, (R), W, T, -
1-bit object for activating or deactivating the operation LED (parameter-dependent).					

Function: actuation LED

Object no.	Function	Name	Type	DPT	Flag
2	Deactivate actuation LED	LED - Input	1-bit	1,001	C, (R), W, T, -
1-bit object for activating or deactivating ("1" = Deactivate; "0" = Activate) the actuation LED (parameter-dependent).					

ALBRECHT JUNG GMBH & CO. KG

Volmestraße 1
58579 Schalksmühle
GERMANY

Telefon: +49 2355 806-0
Telefax: +49 2355 806-204
kundencenter@jung.de
www.jung.de